

NLAS4051

Analog Multiplexer/ Demultiplexer

TTL Compatible, Single-Pole, 8-Position Plus Common Off

The NLAS4051 is an improved version of the MC14051 and MC74HC4051 fabricated in sub-micron Silicon Gate CMOS technology for lower $R_{DS(on)}$ resistance and improved linearity with low current. This device may be operated either with a single supply or dual supply up to ± 3.0 V to pass a 6.0 V_{PP} signal without coupling capacitors.

When operating in single supply mode, it is only necessary to tie V_{EE}, pin 7 to ground. For dual supply operation, V_{EE} is tied to a negative voltage, not to exceed maximum ratings.

Features

- Improved $R_{DS(on)}$ Specifications
- Pin for Pin Replacement for MAX4051 and MAX4051A
 - ◆ One Half the Resistance Operating at 5.0 V
- Single or Dual Supply Operation
 - ◆ Single 2.5–5.0 V Operation, or Dual ± 3.0 V Operation
 - ◆ With V_{CC} of 3.0 to 3.3 V, Device Can Interface with 1.8 V Logic, No Translators Needed
 - ◆ Address and Inhibit Logic are Over-Voltage Tolerant and May Be Driven Up +6.0 V Regardless of V_{CC}
- Improved Linearity Over Standard HC4051 Devices
- Popular SOIC, and Space Saving TSSOP, and QSOP 16 Pin Packages
- Pb-Free Packages are Available*



Figure 1. Pin Connection
(Top View)



ON Semiconductor®

<http://onsemi.com>

MARKING DIAGRAMS

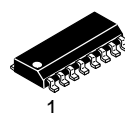

SOIC-16
D SUFFIX
CASE 751B

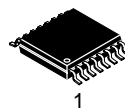
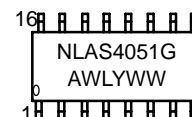

TSSOP-16
DT SUFFIX
CASE 948F

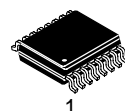
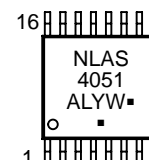

QSOP-16
QS SUFFIX
CASE 492

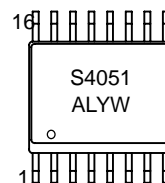

A = Assembly Location
WL, L = Wafer Lot
Y = Year
WW, W = Work Week
G or ■ = Pb-Free Package

ORDERING INFORMATION

Device	Package	Shipping†
NLAS4051DR2	SOIC-16	2500/Tape & Reel
NLAS4051DR2G	SOIC-16 (Pb-Free)	2500/Tape & Reel
NLAS4051DTR2	TSSOP-16	2500/Tape & Reel
NLAS4051DTR2G	TSSOP-16 (Pb-Free)	2500/Tape & Reel
NLAS4051QSR	QSOP-16	2500/Tape & Reel

†For information on tape and reel specifications, including part orientation and tape sizes, please refer to our Tape and Reel Packaging Specifications Brochure, BRD8011/D.

*For additional information on our Pb-Free strategy and soldering details, please download the ON Semiconductor Soldering and Mounting Techniques Reference Manual, SOLDERRM/D.

NLAS4051

TRUTH TABLE

Inhibit	Address			ON SWITCHES*
	C	B	A	
1	X don't care	X don't care	X don't care	All switches open
0	0	0	0	COM-NO ₀
0	0	0	1	COM-NO ₁
0	0	1	0	COM-NO ₂
0	0	1	1	COM-NO ₃
0	1	0	0	COM-NO ₄
0	1	0	1	COM-NO ₅
0	1	1	0	COM-NO ₆
0	1	1	1	COM-NO ₇

*NO and COM pins are identical and interchangeable. Either may be considered an input or output; signals pass equally well in either direction.

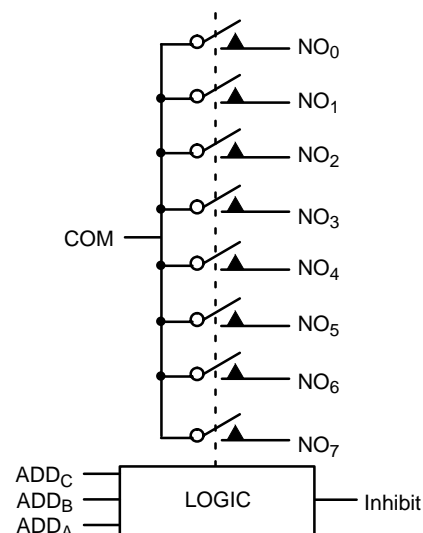

Figure 2. Logic Diagram

MAXIMUM RATINGS

Parameter	Symbol	Value	Unit
Negative DC Supply Voltage (Referenced to GND)	V_{EE}	-7.0 to +0.5	V
Positive DC Supply Voltage (Note 1) (Referenced to GND) (Referenced to V_{EE})	V_{CC}	-0.5 to +7.0 -0.5 to +7.0	V
Analog Input Voltage	V_{IS}	$V_{EE} - 0.5$ to $V_{CC} + 0.5$	V
Digital Input Voltage (Referenced to GND)	V_{IN}	-0.5 to 7.0	V
DC Current, Into or Out of Any Pin	I	± 50	mA
Storage Temperature Range	T_{STG}	-65 to +150	°C
Lead Temperature, 1 mm from Case for 10 Seconds	T_L	260	°C
Junction Temperature under Bias	T_J	+150	°C
Thermal Resistance	θ_{JA}	SOIC 143 TSSOP 164 QSOP 164	°C/W
Power Dissipation in Still Air,	P_D	SOIC 500 TSSOP 450 QSOP 450	mW
Moisture Sensitivity	MSL	Level 1	
Flammability Rating	F_R	Oxygen Index: 30% – 35% UL 94 V-0 @ 0.125 in	
ESD Withstand Voltage	V_{ESD}	Human Body Model (Note 2) > 2000 Machine Model (Note 3) > 200 Charged Device Model (Note 4) > 1000	V
Latchup Performance	$I_{LATCHUP}$	Above V_{CC} and Below GND at 125°C (Note 5) ± 300	mA

Stresses exceeding Maximum Ratings may damage the device. Maximum Ratings are stress ratings only. Functional operation above the Recommended Operating Conditions is not implied. Extended exposure to stresses above the Recommended Operating Conditions may affect device reliability.

1. The absolute value of $V_{CC} \pm |V_{EE}| \leq 7.0$.
2. Tested to EIA/JESD22-A114-A.
3. Tested to EIA/JESD22-A115-A.
4. Tested to JESD22-C101-A.
5. Tested to EIA/JESD78.

NLAS4051

RECOMMENDED OPERATING CONDITIONS

Parameter	Symbol	Min	Max	Unit
Negative DC Supply Voltage (Referenced to GND)	V_{EE}	-5.5	GND	V
Positive DC Supply Voltage (Referenced to GND) (Referenced to V_{EE})	V_{CC}	2.5 2.5	5.5 6.6	V
Analog Input Voltage	V_{IS}	V_{EE}	V_{CC}	V
Digital Input Voltage (Note 6) (Referenced to GND)	V_{IN}	0	5.5	V
Operating Temperature Range, All Package Types	T_A	-55	125	°C
Input Rise/Fall Time (Channel Select or Enable Inputs)	t_r, t_f	0 0	100 20	ns/V
		$V_{CC} = 3.0 \text{ V} \pm 0.3 \text{ V}$ $V_{CC} = 5.0 \text{ V} \pm 0.5 \text{ V}$		

6. Unused digital inputs may not be left open. All digital inputs must be tied to a high-logic voltage level or a low-logic input voltage level.

DC CHARACTERISTICS – Digital Section (Voltages Referenced to GND)

Parameter	Condition	Symbol	V_{CC} V	Guaranteed Limit			Unit
				-55 to 25°C	≤ 85°C	≤ 125°C	
Minimum High-Level Input Voltage, Address and Inhibit Inputs		V_{IH}	2.5	1.75	1.75	1.75	V
			3.0	2.1	2.1	2.1	
			4.5	3.15	3.15	3.15	
			5.5	3.85	3.85	3.85	
Maximum Low-Level Input Voltage, Address and Inhibit Inputs		V_{IL}	2.5	.45	.45	.45	V
			3.0	0.9	0.9	0.9	
			4.5	1.35	1.35	1.35	
			5.5	1.65	1.65	1.65	
Maximum Input Leakage Current, Address or Inhibit Inputs	$V_{IN} = 6.0$ or GND	I_{IN}	0 V to 6.0 V	± 0.1	± 1.0	± 1.0	µA
Maximum Quiescent Supply Current (per Package)	Address, Inhibit and $V_{IS} = V_{CC}$ or GND	I_{CC}	6.0	4.0	40	80	µA

DC ELECTRICAL CHARACTERISTICS – Analog Section

Parameter	Test Conditions	Symbol	V_{CC} V	V_{EE} V	Guaranteed Limit			Unit
					-55 to 25°C	≤ 85°C	≤ 125°C	
Maximum "ON" Resistance (Note 7)	$V_{IN} = V_{IL}$ or V_{IH} $V_{IS} = (V_{EE} \text{ to } V_{CC})$ $ I_S = 10 \text{ mA}$ (Figures 4 thru 9)	R_{ON}	3.0	0	86	108	120	Ω
			4.5	0	37	46	55	
			3.0	-3.0	26	33	37	
Maximum Difference in "ON" Resistance Between Any Two Channels in the Same Package	$V_{IN} = V_{IL}$ or V_{IH} , $V_{IS} = 2.0 \text{ V}$ $V_{IS} = \frac{1}{2}(V_{CC} - V_{EE})$, $V_{IS} = 3.0 \text{ V}$ $ I_S = 10 \text{ mA}$, $V_{IS} = 2.0 \text{ V}$	ΔR_{ON}	3.0	0	15	20	20	Ω
			4.5	0	13	18	18	
			3.0	-3.0	10	15	15	
ON Resistance Flatness	$ I_S = 10 \text{ mA}$ $V_{COM} = 1, 2, 3.5 \text{ V}$ $V_{COM} = 2, 0, 2 \text{ V}$	$R_{flat(ON)}$	4.5 3.0	3.0	4 2	4 2	5 3	Ω
Maximum Off-Channel Leakage Current	Switch Off $V_{IN} = V_{IL}$ or V_{IH} $V_{IO} = V_{CC} - 1.0 \text{ V}$ or $V_{EE} + 1.0 \text{ V}$ (Figure 17)	$I_{NC(OFF)}$ $I_{NO(OFF)}$	6.0	0	0.1	5.0	100	nA
			3.0	-3.0	0.1	5.0	100	
Maximum On-Channel Leakage Current, Channel- to-Channel	Switch On $V_{IO} = V_{CC} - 1.0 \text{ V}$ or $V_{EE} + 1.0 \text{ V}$ (Figure 17)	$I_{COM(ON)}$	6.0	0	0.1	5.0	100	nA
			3.0	-3.0	0.1	5.0	100	

7. At supply voltage (V_{CC}) approaching 2.5 V the analog switch on-resistance becomes extremely non-linear. Therefore, for low voltage operation it is recommended that these devices only be used to control digital signals.

NLAS4051

AC CHARACTERISTICS (Input $t_r = t_f = 3$ ns)

Parameter	Test Conditions	Symbol	V_{CC} V	V_{EE} V	Guaranteed Limit				Unit
					-55 to 25°C		≤ 85°C	≤ 125°C	
					Min	Typ*			
Minimum Break-Before-Make Time	$V_{IN} = V_{IL}$ or V_{IH} $V_{IS} = V_{CC}$ $R_L = 300 \Omega$, $C_L = 35$ pF (Figure 19)	t_{BBM}	3.0 4.5 3.0	0.0 0.0 -3.0	1.0 1.0 1.0	6.5 5.0 3.5	- - -	- - -	ns

*Typical Characteristics are at 25°C.

AC CHARACTERISTICS ($C_L = 35$ pF, Input $t_r = t_f = 3$ ns)

Parameter	Symbol	V_{CC} V	V_{EE} V	Guaranteed Limit						Unit	
				-55 to 25°C			≤ 85°C		≤ 125°C		
				Min	Typ	Max	Min	Max	Min		Max
Transition Time (Address Selection Time) (Figure 18)	t_{TRANS}	2.5	0		22	40		45		50	ns
		3.0	0		20	28		30		35	
		4.5	0		16	23		25		30	
		3.0	-3.0		16	23		25		28	
Turn-on Time (Figures 14, 15, 20, and 21) Inhibit to N_O or N_C	t_{ON}	2.5	0		22	40		45		50	ns
		3.0	0		18	28		30		35	
		4.5	0		16	23		25		30	
		3.0	-3.0		16	23		25		28	
Turn-off Time (Figures 14, 15, 20, and 21) Inhibit to N_O or N_C	t_{OFF}	2.5	0		22	40		45		50	ns
		3.0	0		18	28		30		35	
		4.5	0		16	23		25		30	
		3.0	-3.0		16	23		25		28	
Typical @ 25°C, $V_{CC} = 5.0$ V											
Maximum Input Capacitance, Select Inputs	C_{IN}			8						pF	
Analog I/O	C_{NO} or C_{NC}			10							
Common I/O	C_{COM}			10							
Feedthrough	$C_{(ON)}$			1.0							

ADDITIONAL APPLICATION CHARACTERISTICS (GND = 0 V)

Parameter	Condition	Symbol	V_{CC} V	V_{EE} V	Typ	Unit
					25°C	
Maximum On-Channel Bandwidth or Minimum Frequency Response	$V_{IS} = \frac{1}{2}(V_{CC} - V_{EE})$ Source Amplitude = 0 dBm (Figures 10 and 22)	BW	3.0	0.0	80	MHz
			4.5	0.0	90	
			6.0	0.0	95	
			3.0	-3.0	95	
Off-Channel Feedthrough Isolation	$f = 100$ kHz; $V_{IS} = \frac{1}{2}(V_{CC} - V_{EE})$ Source = 0 dBm (Figures 12 and 22)	V_{ISO}	3.0	0.0	-93	dB
			4.5	0.0	-93	
			6.0	0.0	-93	
			3.0	-3.0	-93	
Maximum Feedthrough On Loss	$V_{IS} = \frac{1}{2}(V_{CC} - V_{EE})$ Source = 0 dBm (Figures 10 and 22)	V_{ONL}	3.0	0.0	-2	dB
			4.5	0.0	-2	
			6.0	0.0	-2	
			3.0	-3.0	-2	
Charge Injection	$V_{IN} = V_{CC}$ to V_{EE} , $f_{IS} = 1$ kHz, $t_r = t_f = 3$ ns $R_{IS} = 0 \Omega$, $C_L = 1000$ pF, $Q = C_L * \Delta V_{OUT}$ (Figures 16 and 23)	Q	5.0	0.0	9.0	pC
			3.0	-3.0	12	
Total Harmonic Distortion THD + Noise	$f_{IS} = 1$ MHz, $R_L = 10$ K Ω , $C_L = 50$ pF, $V_{IS} = 5.0$ V _{PP} sine wave $V_{IS} = 6.0$ V _{PP} sine wave (Figure 13)	THD	6.0	0.0	0.10	%
			3.0	-3.0	0.05	

NLAS4051

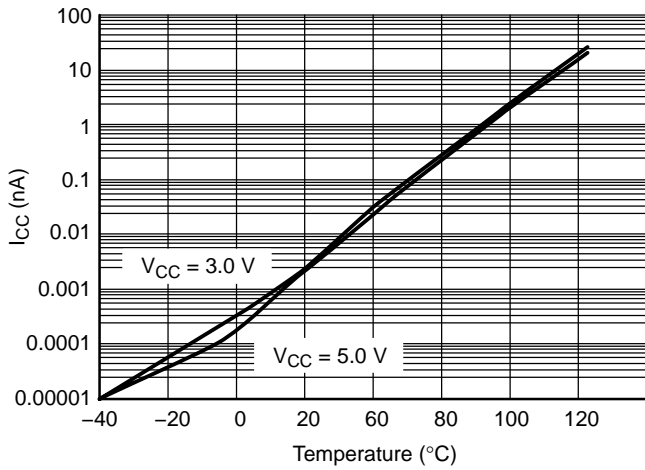

Figure 3. I_{CC} versus Temp, $V_{CC} = 3\text{ V}$ and 5 V

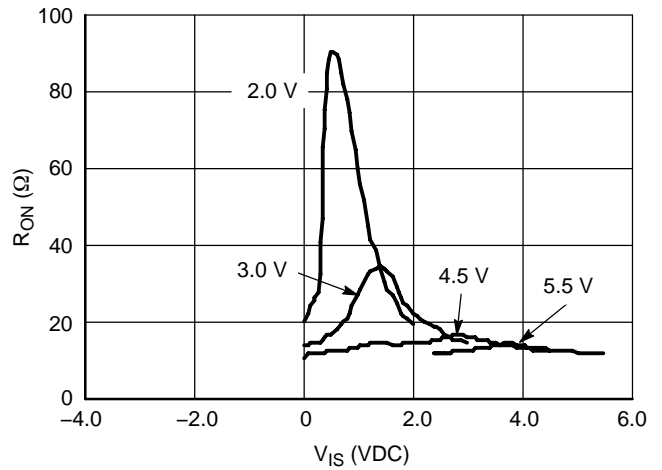

Figure 4. R_{ON} versus V_{CC} , Temp = 25°C

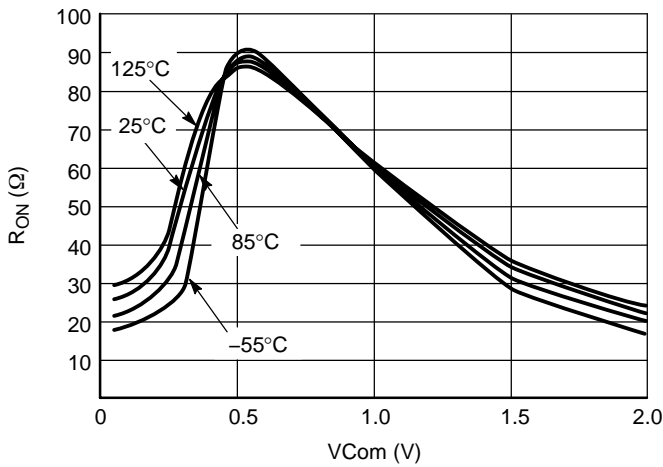

Figure 5. Typical On Resistance
 $V_{CC} = 2.0\text{ V}$, $V_{EE} = 0\text{ V}$

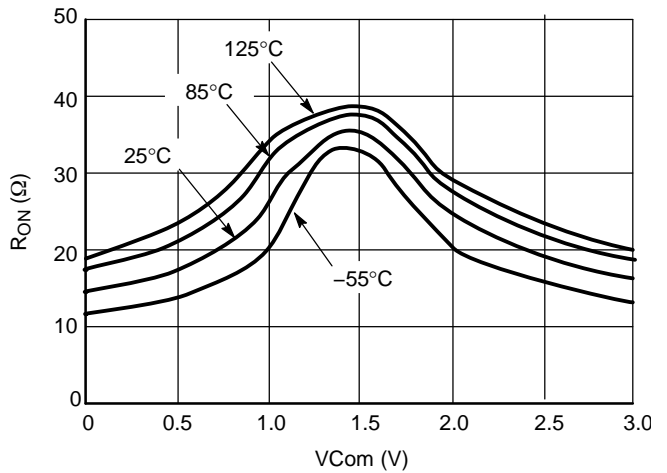

Figure 6. Typical On Resistance
 $V_{CC} = 3.0\text{ V}$, $V_{EE} = 0\text{ V}$

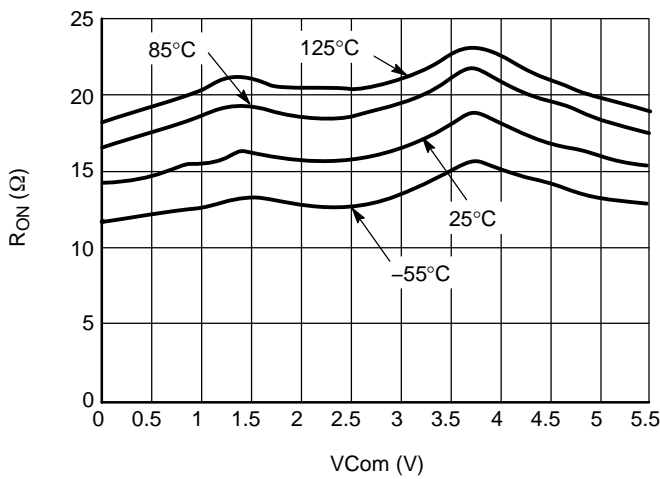

Figure 7. Typical On Resistance
 $V_{CC} = 4.5\text{ V}$, $V_{EE} = 0\text{ V}$

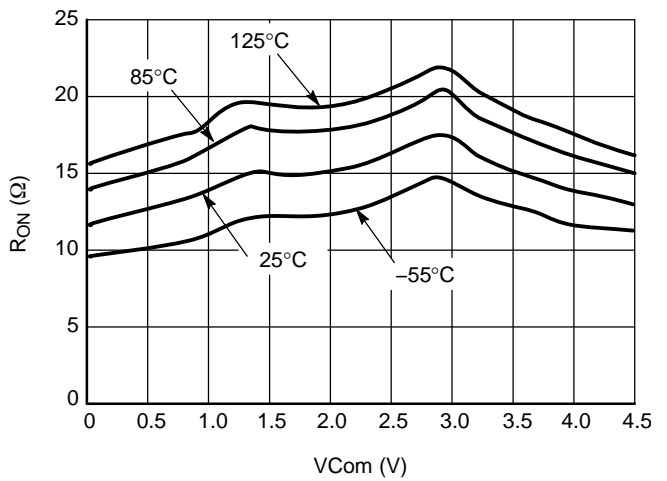

Figure 8. Typical On Resistance
 $V_{CC} = 5.5\text{ V}$, $V_{EE} = 0\text{ V}$

NLAS4051

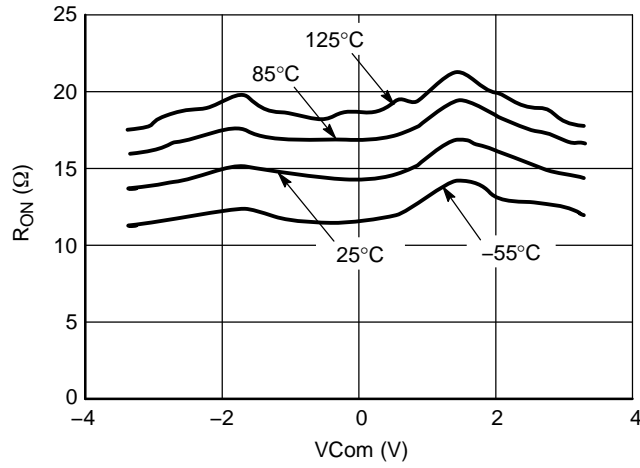

Figure 9. Typical On Resistance
 $V_{CC} = 3.3 \text{ V}, V_{EE} = -3.3 \text{ V}$

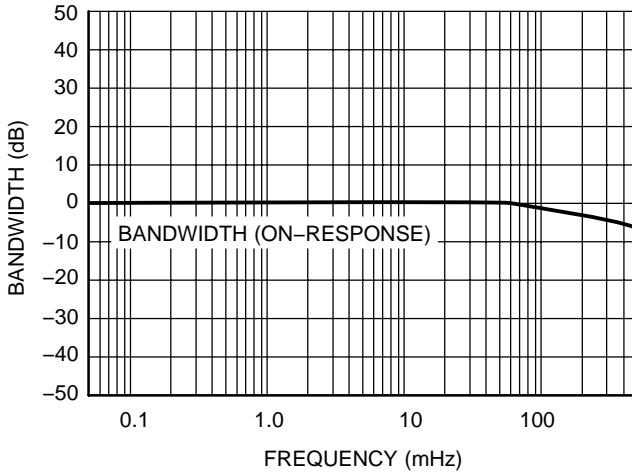

Figure 10. Bandwidth, $V_{CC} = 5.0 \text{ V}$

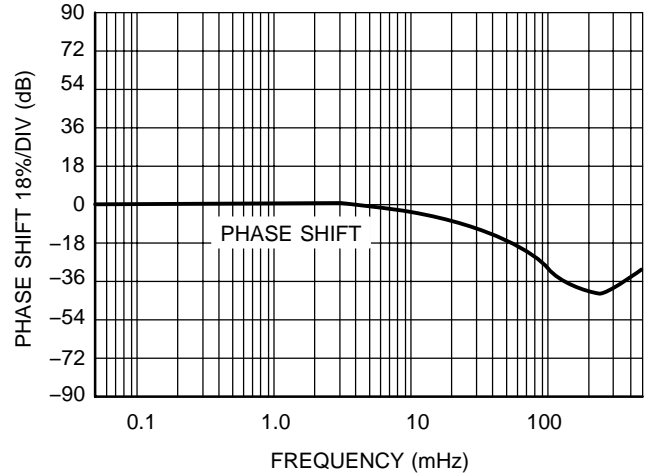

Figure 11. Phase Shift, $V_{CC} = 5.0 \text{ V}$

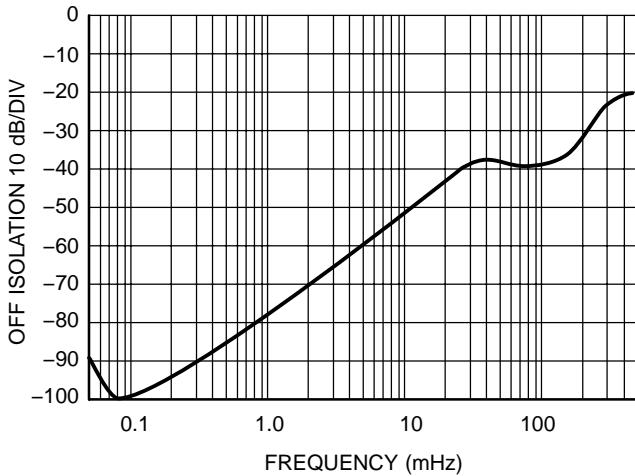

Figure 12. Off Isolation, $V_{CC} = 5.0 \text{ V}$

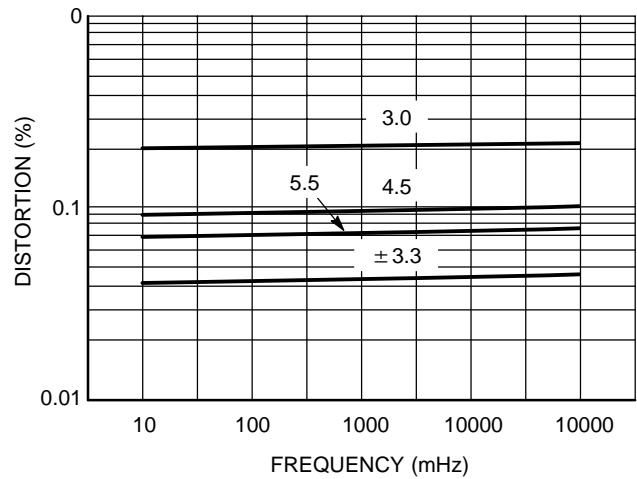

Figure 13. Total Harmonic Distortion

NLAS4051

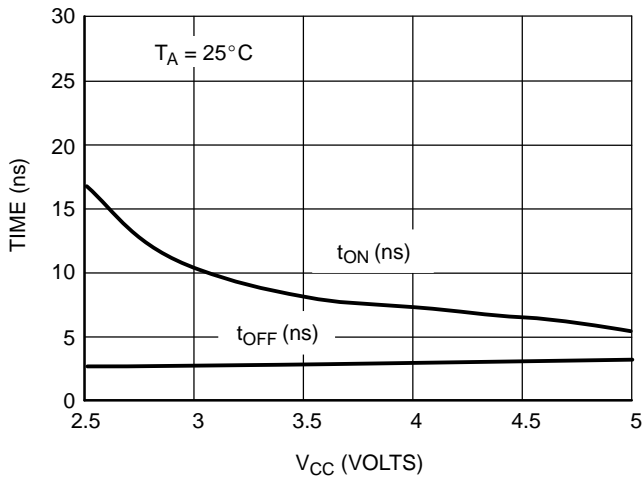

Figure 14. t_{ON} and t_{OFF} versus V_{CC}

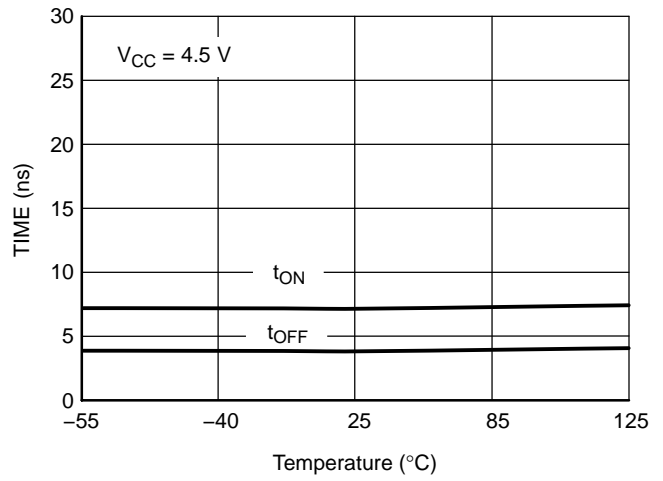

Figure 15. t_{ON} and t_{OFF} versus Temp

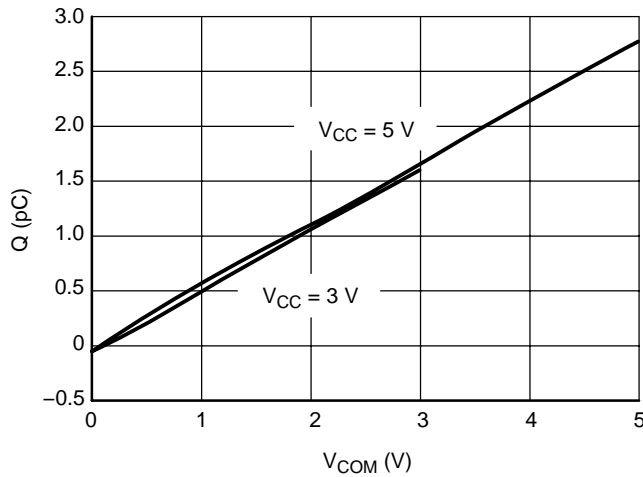

Figure 16. Charge Injection versus COM Voltage

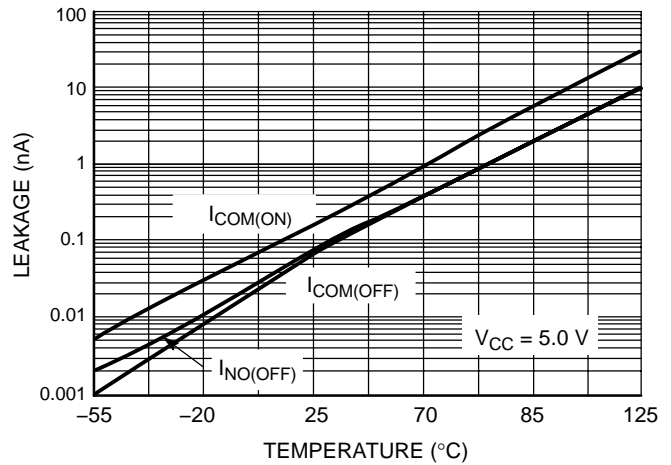

Figure 17. Switch Leakage versus Temperature

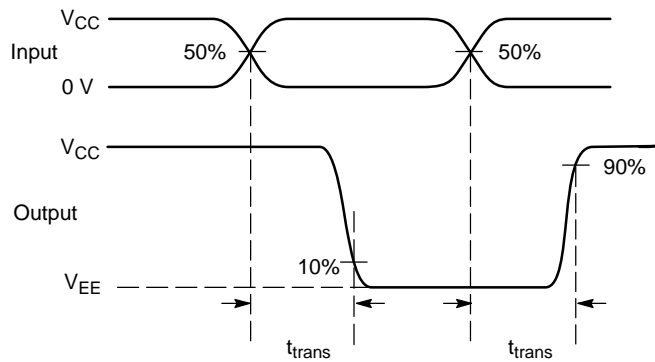
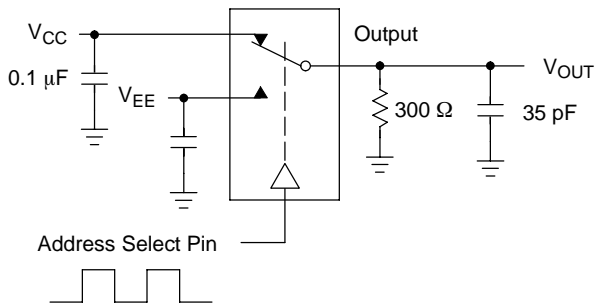

Figure 18. Channel Selection Propagation Delay

NLAS4051

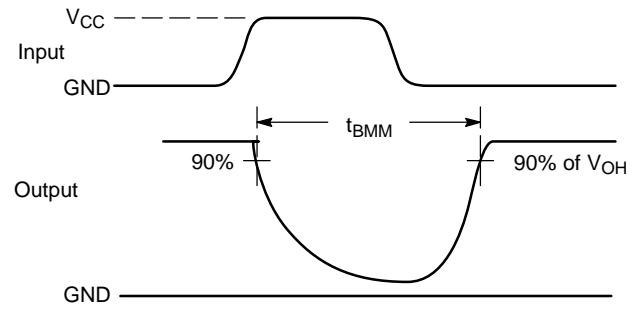
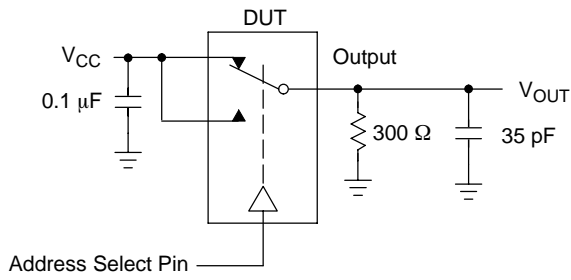

Figure 19. t_{BMM} (Time Break-Before-Make)

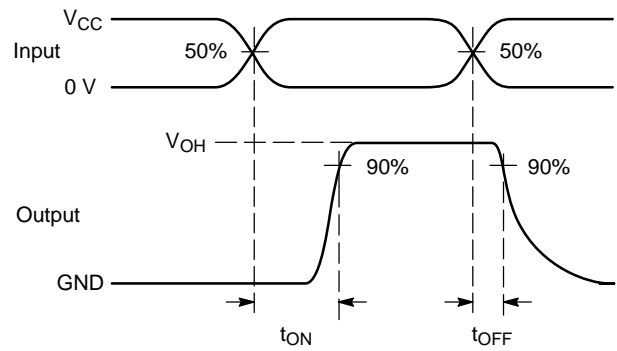
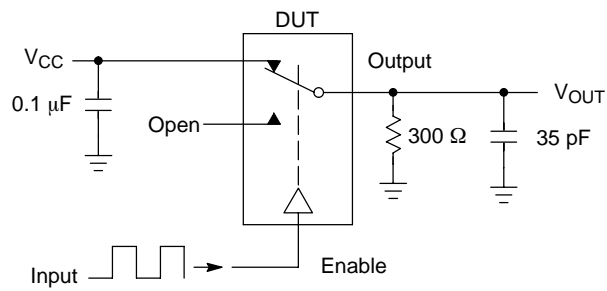

Figure 20. t_{ON}/t_{OFF}

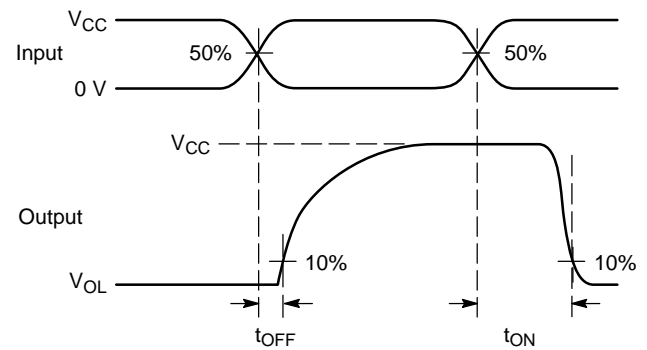
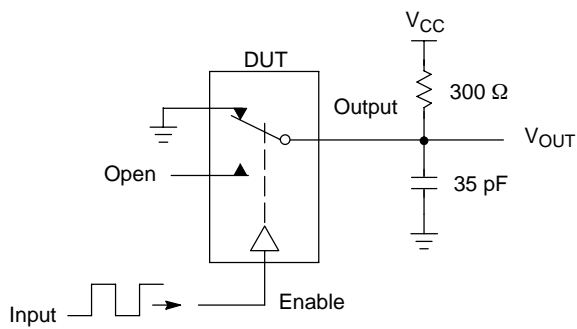
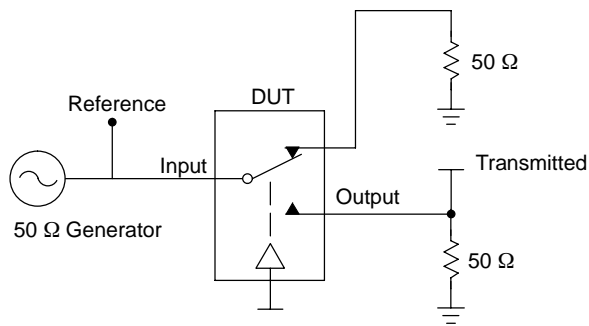

Figure 21. t_{ON}/t_{OFF}

NLAS4051



Channel switch Address and Inhibit/s test socket is normalized. Off isolation is measured across an off channel. On loss is the bandwidth of an On switch. V_{ISO} , Bandwidth and V_{ONL} are independent of the input signal direction.

$$V_{ISO} = \text{Off Channel Isolation} = 20 \text{ Log} \left(\frac{V_{OUT}}{V_{IN}} \right) \text{ for } V_{IN} \text{ at } 100 \text{ kHz}$$

$$V_{ONL} = \text{On Channel Loss} = 20 \text{ Log} \left(\frac{V_{OUT}}{V_{IN}} \right) \text{ for } V_{IN} \text{ at } 100 \text{ kHz to } 50 \text{ MHz}$$

Bandwidth (BW) = the frequency 3 dB below V_{ONL}

Figure 22. Off Channel Isolation/On Channel Loss (BW)/Crosstalk (On Channel to Off Channel)/ V_{ONL}

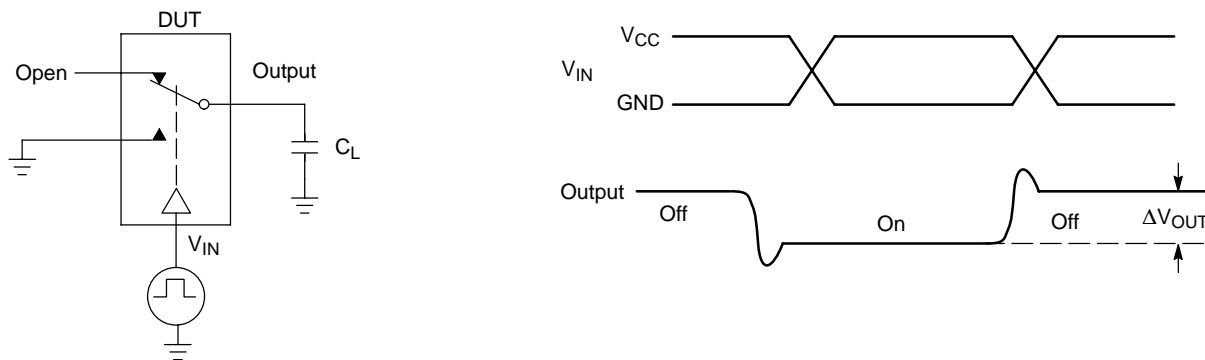

Figure 23. Charge Injection: (Q)

TYPICAL OPERATION

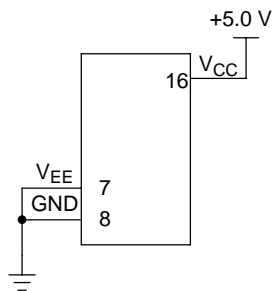

Figure 24. 5.0 Volts Single Supply
 $V_{CC} = 5.0 \text{ V}, V_{EE} = 0$

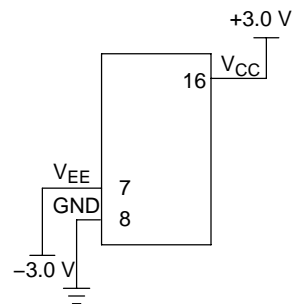
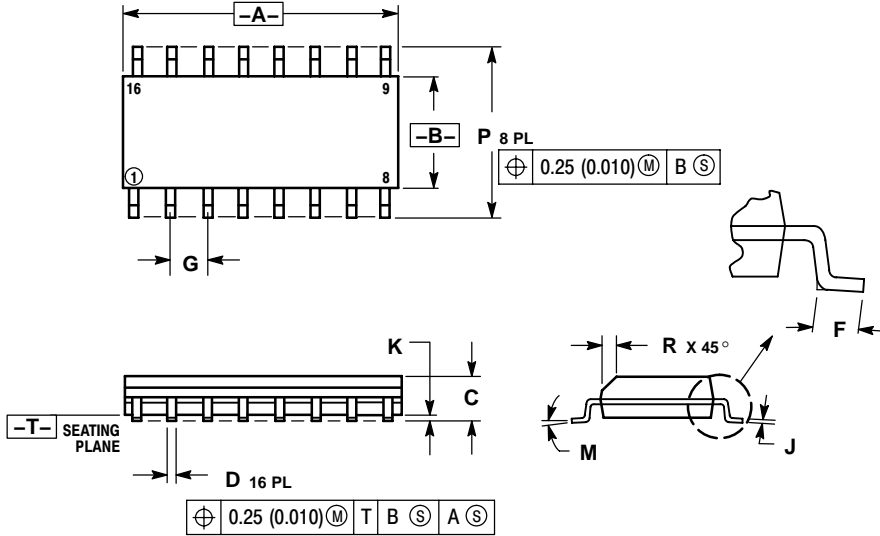

Figure 25. Dual Supply
 $V_{CC} = 3.0 \text{ V}, V_{EE} = -3.0 \text{ V}$

NLAS4051

PACKAGE DIMENSIONS

SOIC-16 D SUFFIX CASE 751B-05 ISSUE J



NOTES:

1. DIMENSIONING AND TOLERANCING PER ANSI Y14.5M, 1982.
2. CONTROLLING DIMENSION: MILLIMETER.
3. DIMENSIONS A AND B DO NOT INCLUDE MOLD PROTRUSION.
4. MAXIMUM MOLD PROTRUSION 0.15 (0.006) PER SIDE.
5. DIMENSION D DOES NOT INCLUDE DAMBAR PROTRUSION. ALLOWABLE DAMBAR PROTRUSION SHALL BE 0.127 (0.005) TOTAL IN EXCESS OF THE D DIMENSION AT MAXIMUM MATERIAL CONDITION.

DIM	MILLIMETERS		INCHES	
	MIN	MAX	MIN	MAX
A	9.80	10.00	0.386	0.393
B	3.80	4.00	0.150	0.157
C	1.35	1.75	0.054	0.068
D	0.35	0.49	0.014	0.019
F	0.40	1.25	0.016	0.049
G	1.27 BSC		0.050 BSC	
J	0.19	0.25	0.008	0.009
K	0.10	0.25	0.004	0.009
M	0°	7°	0°	7°
P	5.80	6.20	0.229	0.244
R	0.25	0.50	0.010	0.019

TSSOP-16 CASE 948F-01 ISSUE A

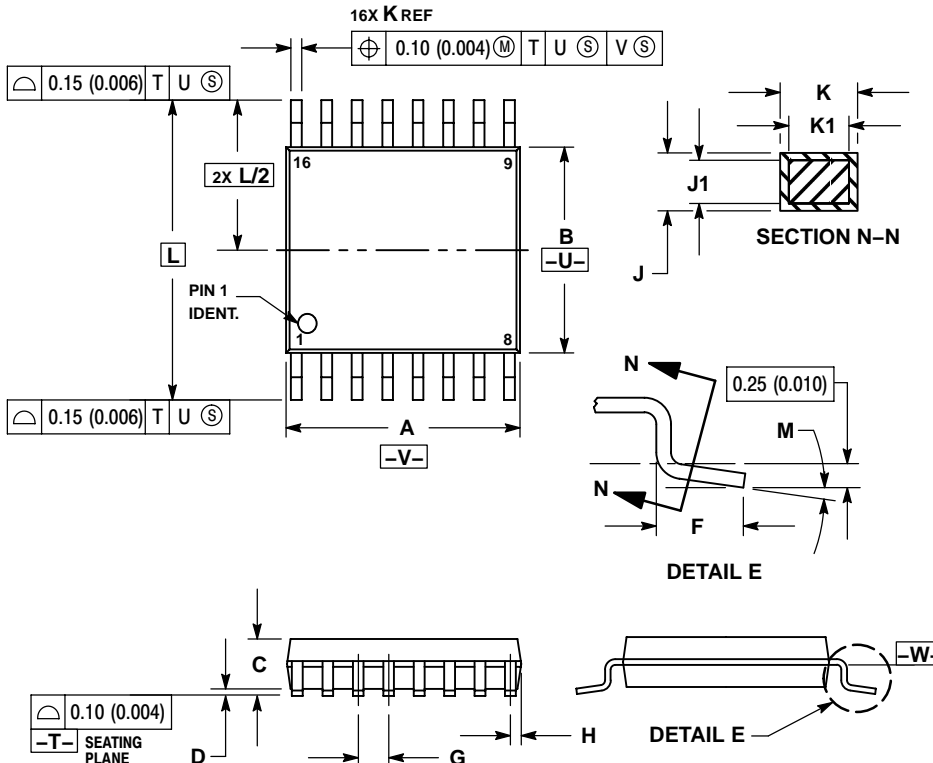

NOTES:

1. DIMENSIONING AND TOLERANCING PER ANSI Y14.5M, 1982.
2. CONTROLLING DIMENSION: MILLIMETER.
3. DIMENSION A DOES NOT INCLUDE MOLD FLASH. PROTRUSIONS OR GATE BURRS. MOLD FLASH OR GATE BURRS SHALL NOT EXCEED 0.15 (0.006) PER SIDE.
4. DIMENSION B DOES NOT INCLUDE INTERLEAD FLASH OR PROTRUSION. INTERLEAD FLASH OR PROTRUSION SHALL NOT EXCEED 0.25 (0.010) PER SIDE.
5. DIMENSION K DOES NOT INCLUDE DAMBAR PROTRUSION. ALLOWABLE DAMBAR PROTRUSION SHALL BE 0.08 (0.003) TOTAL IN EXCESS OF THE K DIMENSION AT MAXIMUM MATERIAL CONDITION.
6. TERMINAL NUMBERS ARE SHOWN FOR REFERENCE ONLY.
7. DIMENSION A AND B ARE TO BE DETERMINED AT DATUM PLANE -W-.

DIM	MILLIMETERS		INCHES	
	MIN	MAX	MIN	MAX
A	4.90	5.10	0.193	0.200
B	4.30	4.50	0.169	0.177
C	---	1.20	---	0.047
D	0.05	0.15	0.002	0.006
F	0.50	0.75	0.020	0.030
G	0.65 BSC		0.026 BSC	
H	0.18	0.28	0.007	0.011
J	0.09	0.20	0.004	0.008
J1	0.09	0.16	0.004	0.006
K	0.19	0.30	0.007	0.012
K1	0.19	0.25	0.007	0.010
L	6.40 BSC		0.252 BSC	
M	0°	8°	0°	8°

NLAS4051

PACKAGE DIMENSIONS

QSOP-16
QS SUFFIX
CASE 492-01
ISSUE O

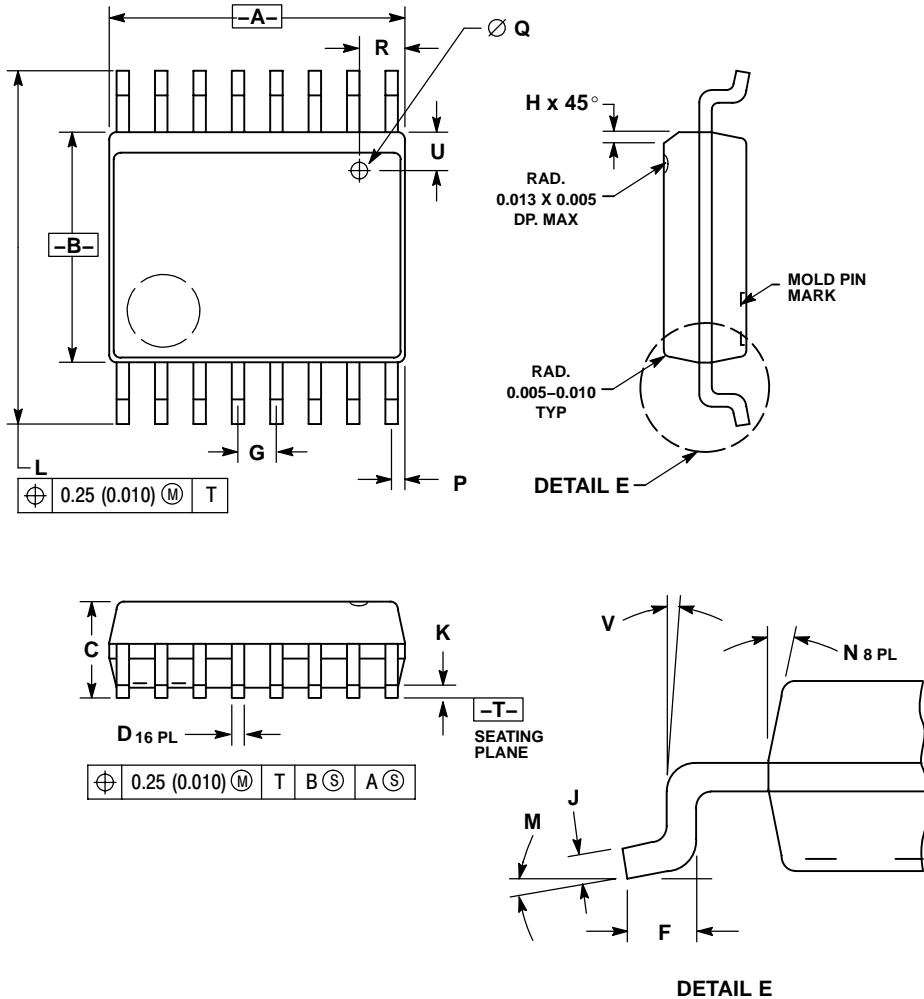

NOTES:

1. DIMENSIONING AND TOLERANCING PER ANSI Y14.5M, 1982.
2. CONTROLLING DIMENSION: INCH.
3. THE BOTTOM PACKAGE SHALL BE BIGGER THAN THE TOP PACKAGE BY 4 MILS (NOTE: LEAD SIDE ONLY). BOTTOM PACKAGE DIMENSION SHALL FOLLOW THE DIMENSION STATED IN THIS DRAWING.
4. PLASTIC DIMENSIONS DOES NOT INCLUDE MOLD FLASH OR PROTRUSIONS. MOLD FLASH OR PROTRUSIONS SHALL NOT EXCEED 6 MILS PER SIDE.
5. BOTTOM EJECTOR PIN WILL INCLUDE THE COUNTRY OF ORIGIN (COO) AND MOLD CAVITY I.D.

DIM	INCHES		MILLIMETERS	
	MIN	MAX	MIN	MAX
A	0.189	0.196	4.80	4.98
B	0.150	0.157	3.81	3.99
C	0.061	0.068	1.55	1.73
D	0.008	0.012	0.20	0.31
F	0.016	0.035	0.41	0.89
G	0.025 BSC		0.64 BSC	
H	0.008	0.018	0.20	0.46
J	0.0098	0.0075	0.249	0.191
K	0.004	0.010	0.10	0.25
L	0.230	0.244	5.84	6.20
M	0°	8°	0°	8°
N	0°	7°	0°	7°
P	0.007	0.011	0.18	0.28
Q	0.020 DIA		0.51 DIA	
R	0.025	0.035	0.64	0.89
U	0.025	0.035	0.64	0.89
V	0°	8°	0°	8°

ON Semiconductor and **ON** are registered trademarks of Semiconductor Components Industries, LLC (SCILLC). SCILLC reserves the right to make changes without further notice to any products herein. SCILLC makes no warranty, representation or guarantee regarding the suitability of its products for any particular purpose, nor does SCILLC assume any liability arising out of the application or use of any product or circuit, and specifically disclaims any and all liability, including without limitation special, consequential or incidental damages. "Typical" parameters which may be provided in SCILLC data sheets and/or specifications can and do vary in different applications and actual performance may vary over time. All operating parameters, including "Typicals" must be validated for each customer application by customer's technical experts. SCILLC does not convey any license under its patent rights nor the rights of others. SCILLC products are not designed, intended, or authorized for use as components in systems intended for surgical implant into the body, or other applications intended to support or sustain life, or for any other application in which the failure of the SCILLC product could create a situation where personal injury or death may occur. Should Buyer purchase or use SCILLC products for any such unintended or unauthorized application, Buyer shall indemnify and hold SCILLC and its officers, employees, subsidiaries, affiliates, and distributors harmless against all claims, costs, damages, and expenses, and reasonable attorney fees arising out of, directly or indirectly, any claim of personal injury or death associated with such unintended or unauthorized use, even if such claim alleges that SCILLC was negligent regarding the design or manufacture of the part. SCILLC is an Equal Opportunity/Affirmative Action Employer. This literature is subject to all applicable copyright laws and is not for resale in any manner.

PUBLICATION ORDERING INFORMATION

LITERATURE FULFILLMENT:

Literature Distribution Center for ON Semiconductor
P.O. Box 5163, Denver, Colorado 80217 USA
Phone: 303-675-2175 or 800-344-3860 Toll Free USA/Canada
Fax: 303-675-2176 or 800-344-3867 Toll Free USA/Canada
Email: orderlit@onsemi.com

N. American Technical Support: 800-282-9855 Toll Free
USA/Canada
Europe, Middle East and Africa Technical Support:
Phone: 421 33 790 2910
Japan Customer Focus Center
Phone: 81-3-5773-3850

ON Semiconductor Website: www.onsemi.com

Order Literature: <http://www.onsemi.com/orderlit>

For additional information, please contact your local Sales Representative

Mouser Electronics

Authorized Distributor

Click to View Pricing, Inventory, Delivery & Lifecycle Information:

[ON Semiconductor:](#)

[NLAS4051DR2G](#) [NLAS4051DTR2G](#)