

Speed TEMPFET®

- N-Channel
- Enhancement mode
- Logic Level Input
- Analog driving possible
- Fast switching up to 1 MHz
- Potential-free temperature sensor with thyristor characteristics
- Overtemperature protection
- Avalanche rated
- High current pinning
- Green Product (RoHS compliant)
- AEC Qualified

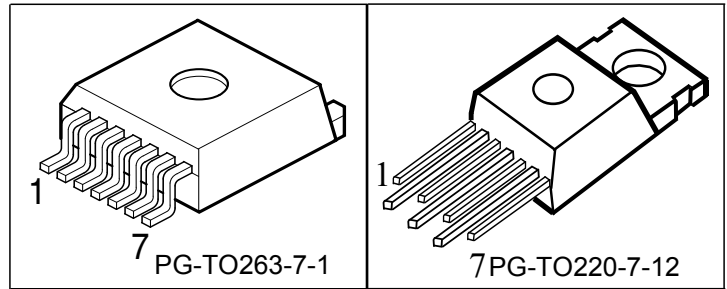

Type	V_{DS}	$R_{DS(on)}$	Package
BTS282Z E3180A	49 V	6.5 mΩ	PG-TO263-7-1
BTS282Z E3230			7PG-TO220-7-12

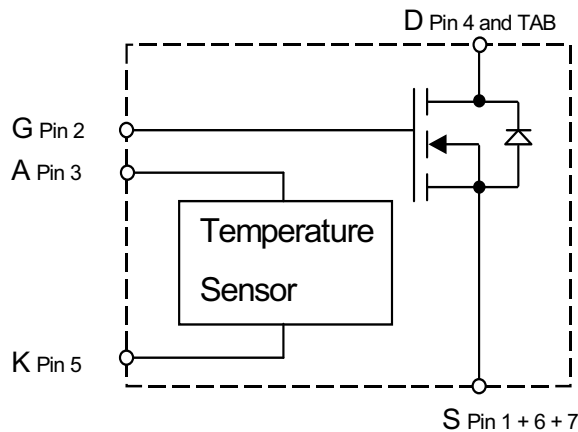

Pin	Symbol	Function
1	S	Source
2	G	Gate
3	A	Anode Temperature Sensor
4	D	Drain
5	K	Cathode Temperature Sensor
6	S	Source
7	S	Source

Maximum Ratings

Parameter	Symbol	Value	Unit
Drain source voltage	V_{DS}	49	V
Drain-gate voltage, $R_{GS} = 20 \text{ k}\Omega$	V_{DGR}	49	
Gate source voltage	V_{GS}	± 20	
Nominal load current (ISO 10483) $V_{GS} = 4.5 \text{ V}$, $V_{DS} \leq 0.5 \text{ V}$, $T_C = 85 \text{ }^\circ\text{C}$ $V_{GS} = 10 \text{ V}$, $V_{DS} \leq 0.5 \text{ V}$, $T_C = 85 \text{ }^\circ\text{C}$	$I_{D(ISO)}$	36 52	A
Continuous drain current ¹⁾ $T_C = 100 \text{ }^\circ\text{C}$, $V_{GS} = 4.5\text{V}$	I_D	80	
Pulsed drain current	$I_{D \text{ puls}}$	320	
Avalanche energy, single pulse $I_D = 36 \text{ A}$, $R_{GS} = 25 \text{ }\Omega$	E_{AS}	2	J
Power dissipation $T_C = 25 \text{ }^\circ\text{C}$	P_{tot}	300	W
Operating temperature ²⁾	T_j	-40 ... +175	$^\circ\text{C}$
Peak temperature (single event)	T_{jpeak}	200	
Storage temperature	T_{stg}	-55 ... +150	
DIN humidity category, DIN 40 040		E	
IEC climatic category; DIN IEC 68-1		40/150/56	

¹current limited by bond wire

²Note: Thermal trip temperature of temperature sensor is below 175°C

Thermal Characteristics

Parameter	Symbol	Values			Unit
		min.	typ.	max.	
Characteristics					
junction - case:	R_{thJC}	-	-	0.5	K/W
Thermal resistance @ min. footprint	$R_{th(JA)}$	-	-	62	
Thermal resistance @ 6 cm ² cooling area ¹⁾	$R_{th(JA)}$	-	33	40	

Electrical Characteristics

Parameter	Symbol	Values			Unit
		min.	typ.	max.	
at $T_j = 25^\circ\text{C}$, unless otherwise specified					

Static Characteristics

Drain-source breakdown voltage $V_{GS} = 0\text{ V}$, $I_D = 0.25\text{ mA}$	$V_{(BR)DSS}$	49	-	-	V
Gate threshold voltage, $V_{GS} = V_{DS}$ $I_D = 240\ \mu\text{A}$	$V_{GS(th)}$	1.2	1.6	2	
Zero gate voltage drain current $V_{DS} = 45\text{ V}$, $V_{GS} = 0\text{ V}$, $T_j = -40\ ^\circ\text{C}$ $V_{DS} = 45\text{ V}$, $V_{GS} = 0\text{ V}$, $T_j = 25\ ^\circ\text{C}$ $V_{DS} = 45\text{ V}$, $V_{GS} = 0\text{ V}$, $T_j = 150\ ^\circ\text{C}$	I_{DSS}	-	-	0.1	μA
		-	0.1	1	
		-	-	100	
Gate-source leakage current $V_{GS} = 20\text{ V}$, $V_{DS} = 0\text{ V}$, $T_j = 25\ ^\circ\text{C}$ $V_{GS} = 20\text{ V}$, $V_{DS} = 0\text{ V}$, $T_j = 150\ ^\circ\text{C}$	I_{GSS}	-	10	100	nA
		-	20	100	
Drain-Source on-state resistance $V_{GS} = 4.5\text{ V}$, $I_D = 36\text{ A}$ $V_{GS} = 10\text{ V}$, $I_D = 36\text{ A}$	$R_{DS(on)}$	-	8.2	9.5	m Ω
		-	5.8	6.5	

¹ Device on 50mm*50mm*1.5mm epoxy PCB FR4 with 6cm² (one layer, 70 μm thick) copper area for drain connection. PCB mounted vertical without blown air.

Electrical Characteristics

Parameter	Symbol	Values			Unit
		min.	typ.	max.	
at $T_j = 25^\circ\text{C}$, unless otherwise specified					

Dynamic Characteristics

Forward transconductance $V_{DS} > 2 \cdot I_D \cdot R_{DS(on)max}$, $I_D = 80\text{ A}$	g_{fs}	30	70	-	S
Input capacitance $V_{GS} = 0\text{ V}$, $V_{DS} = 25\text{ V}$, $f = 1\text{ MHz}$	C_{iss}	-	3850	4800	pF
Output capacitance $V_{GS} = 0\text{ V}$, $V_{DS} = 25\text{ V}$, $f = 1\text{ MHz}$	C_{oss}	-	1090	1357	
Reverse transfer capacitance $V_{GS} = 0\text{ V}$, $V_{DS} = 25\text{ V}$, $f = 1\text{ MHz}$	C_{rss}	-	570	715	
Turn-on delay time $V_{DD} = 30\text{ V}$, $V_{GS} = 4.5\text{ V}$, $I_D = 80\text{ A}$, $R_G = 1.3\ \Omega$	$t_{d(on)}$	-	30	45	ns
Rise time $V_{DD} = 30\text{ V}$, $V_{GS} = 4.5\text{ V}$, $I_D = 80\text{ A}$, $R_G = 1.3\ \Omega$	t_r	-	37	56	
Turn-off delay time $V_{DD} = 30\text{ V}$, $V_{GS} = 4.5\text{ V}$, $I_D = 80\text{ A}$, $R_G = 1.3\ \Omega$	$t_{d(off)}$	-	70	105	
Fall time $V_{DD} = 30\text{ V}$, $V_{GS} = 4.5\text{ V}$, $I_D = 80\text{ A}$, $R_G = 1.3\ \Omega$	t_f	-	36	55	

Gate Charge Characteristics

Gate charge at threshold $V_{DD} = 40\text{ V}$, $I_D \geq 0,1\text{ A}$, $V_{GS} = 0\text{ to }1\text{ V}$	$Q_{g(th)}$	-	3.8	5.7	nC
Gate charge at 5.0 V $V_{DD} = 40\text{ V}$, $I_D = 80\text{ A}$, $V_{GS} = 0\text{ to }5\text{ V}$	$Q_{g(5)}$	-	92	138	
Gate charge total $V_{DD} = 40\text{ V}$, $I_D = 80\text{ A}$, $V_{GS} = 0\text{ to }10\text{ V}$	$Q_{g(total)}$	-	155	232	
Gate plateau voltage $V_{DD} = 40\text{ V}$, $I_D = 80\text{ A}$	$V_{(plateau)}$	-	3.4	-	V

Electrical Characteristics

Parameter at $T_j = 25^\circ\text{C}$, unless otherwise specified	Symbol	Values			Unit
		min.	typ.	max.	
Reverse Diode					
Inverse diode continuous forward current $T_C = 25^\circ\text{C}$	I_S	80	-	-	A
Inverse diode direct current, pulsed $T_C = 25^\circ\text{C}$	I_{FM}	320	-	-	
Inverse diode forward voltage $V_{GS} = 0\text{ V}$, $I_F = 95\text{ A}$	V_{SD}	-	1.25	1.6	V
Reverse recovery time $V_R = 30\text{ V}$, $I_F = I_S$, $di_F/dt = 100\text{ A}/\mu\text{s}$	t_{rr}	-	105	157	ns
Reverse recovery charge $V_R = 30\text{ V}$, $I_F = I_S$, $di_F/dt = 100\text{ A}/\mu\text{s}$	Q_{rr}	-	0.31	0.47	μC

Sensor Characteristics

For temperature sensing, i.e. temperature protection, please consider application note "Temperature sense concept - Speed TEMPFET".

For short circuit protection please consider application note "Short circuit behaviour of the Speed TEMPFET family".

All application notes are available at <http://www.infineon.com/tempfet/>

Forward voltage $I_{AK(on)} = 5\text{ mA}$, $T_j = -40\dots+150^\circ\text{C}$ $I_{AK(on)} = 1.5\text{ mA}$, $T_j = 150^\circ\text{C}$	$V_{AK(on)}$	-	1.3	1.4	V
Sensor override $t_P = 100\ \mu\text{s}$, $T_j = -40\dots+150^\circ\text{C}$		-	-	10	
Forward current $T_j = -40\dots+150^\circ\text{C}$	$I_{AK(on)}$	-	-	5	
Sensor override $t_P = 100\ \mu\text{s}$, $T_j = -40\dots+150^\circ\text{C}$		-	-	600	

Electrical Characteristics

Parameter at $T_j = 25^\circ\text{C}$, unless otherwise specified	Symbol	Values			Unit
		min.	typ.	max.	

Sensor Characteristics

Temperature sensor leakage current $T_j = 150^\circ\text{C}$	$I_{AK(\text{off})}$	-	-	4	μA
Min. reset pulse duration ¹⁾ $T_j = -40\dots+150^\circ\text{C}$, $I_{AK(\text{on})} = 0.3\text{ mA}$, $V_{AK(\text{Reset})} < 0.5\text{V}$	t_{reset}	100	-	-	μs
V_{AK} Recovery time ¹⁾²⁾ $T_j = -40\dots+150^\circ\text{C}$, $I_{AK(\text{on})} = 0.3\text{ mA}$	t_{recovery}	-	-	150	

Characteristics

Holding current, $V_{AK(\text{off})} = 5\text{V}$ $T_j = 25^\circ\text{C}$ $T_j = 150^\circ\text{C}$	$I_{AK(\text{hold})}$	0.05 0.05	- -	0.5 0.3	mA
Thermal trip temperature $V_{TS} = 5\text{V}$	$T_{TS(\text{on})}$	150	160	170	$^\circ\text{C}$
Turn-off time (Pin G+A and K+S connected) $V_{TS} = 5\text{V}$, $I_{TS(\text{on})} = 2\text{ mA}$	t_{off}	0.5	-	2.5	μs
Reset voltage $T_j = -40\dots+150^\circ\text{C}$	$V_{AK(\text{reset})}$	0.5	-	-	V

Sensor recovery behaviour:

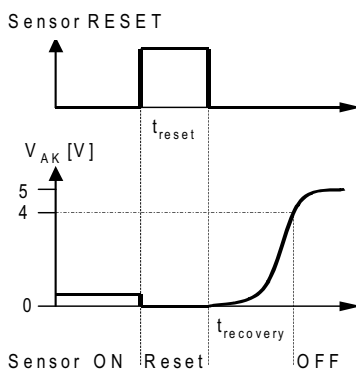

¹See diagram Sensor recovery behaviour

²Time after reset pulse until V_{AK} reaches 4V again

1 Maximum allowable power dissipation

$$P_{\text{tot}} = f(T_C)$$

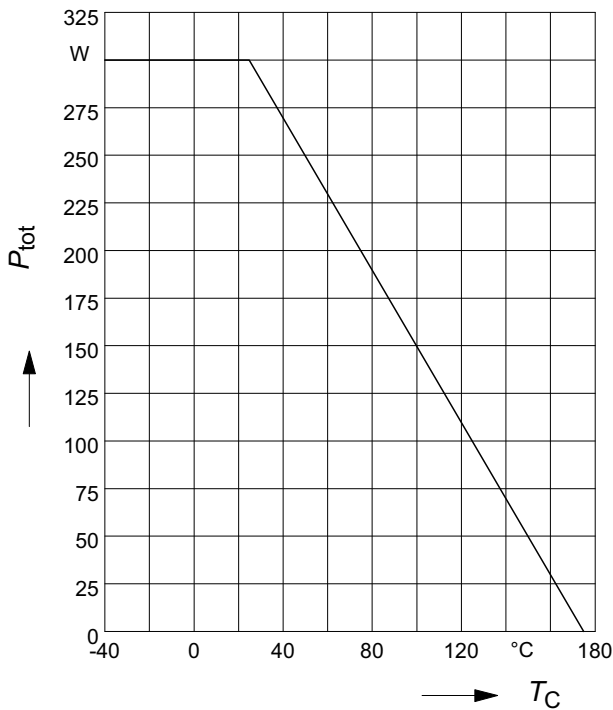

2 Drain current

$$I_D = f(T_C); V_{GS} \geq 4.5V$$

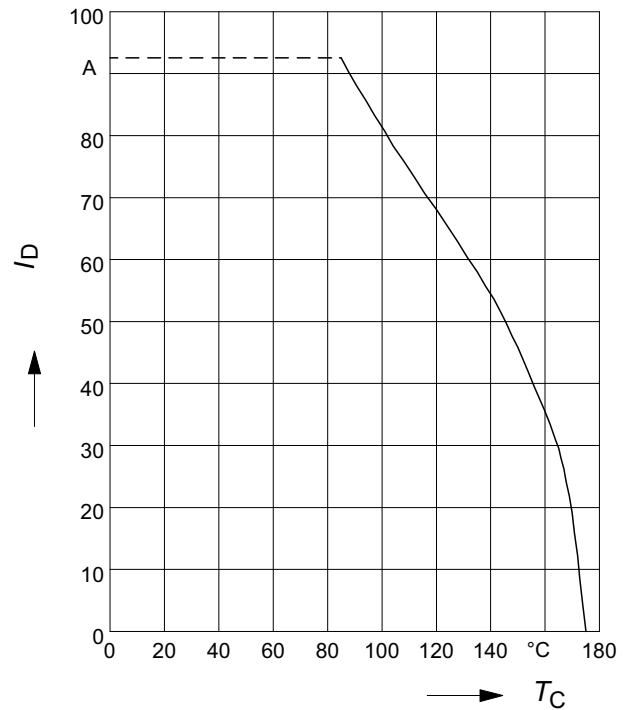

3 Typ. transient thermal impedance

$$Z_{\text{thJA}} = f(t_p) \text{ @ } 6 \text{ cm}^2 \text{ cooling area}$$

Parameter: $D = t_p / T$

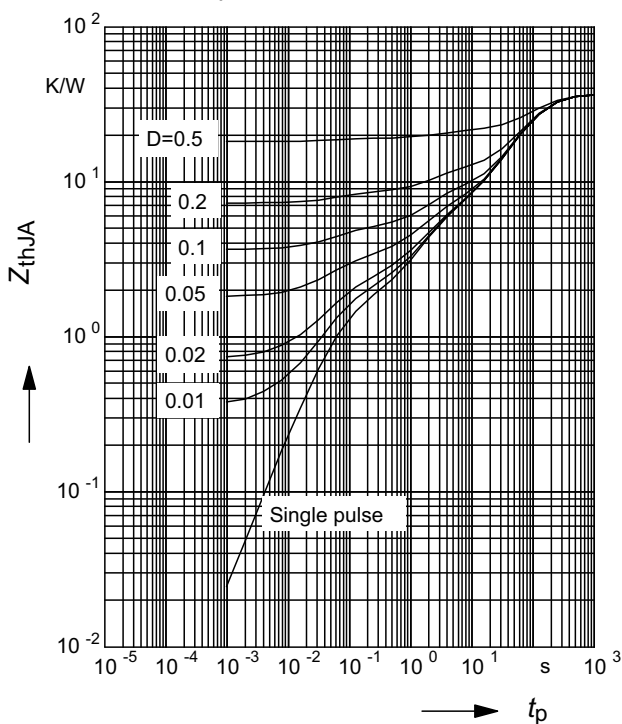

4 Transient thermal impedance

$$Z_{\text{thJC}} = f(t_p)$$

parameter : $D = t_p / T$

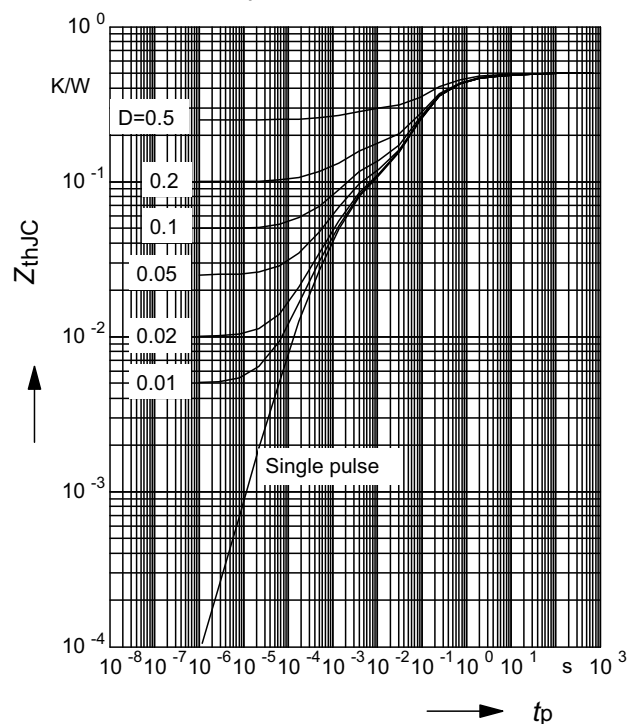

5 Safe operating area

$I_D = f(V_{DS}); D=0.01; T_C=25^\circ\text{C}$

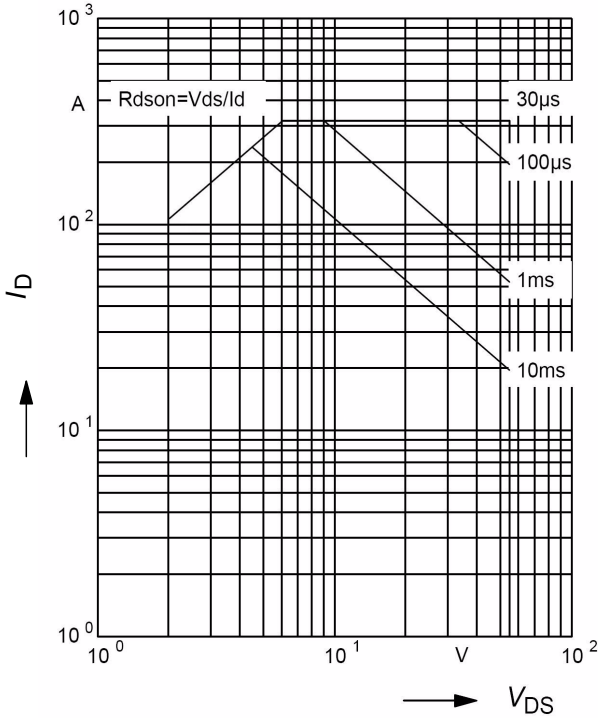

6 Typ. output characteristic

$I_D = f(V_{DS}); T_j=25^\circ\text{C}$

Parameter: V_{GS}

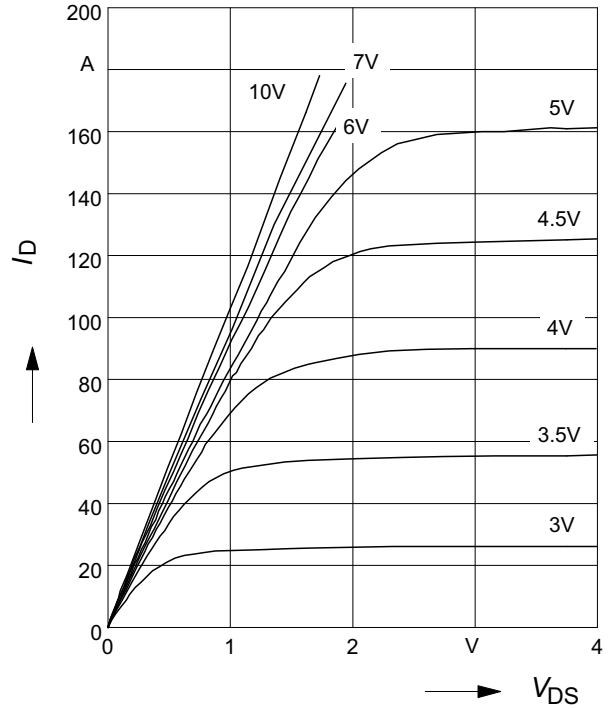

7 On-state resistance

$R_{ON} = f(T_j); I_D=36\text{A}; V_{GS} = 4.5\text{V}$

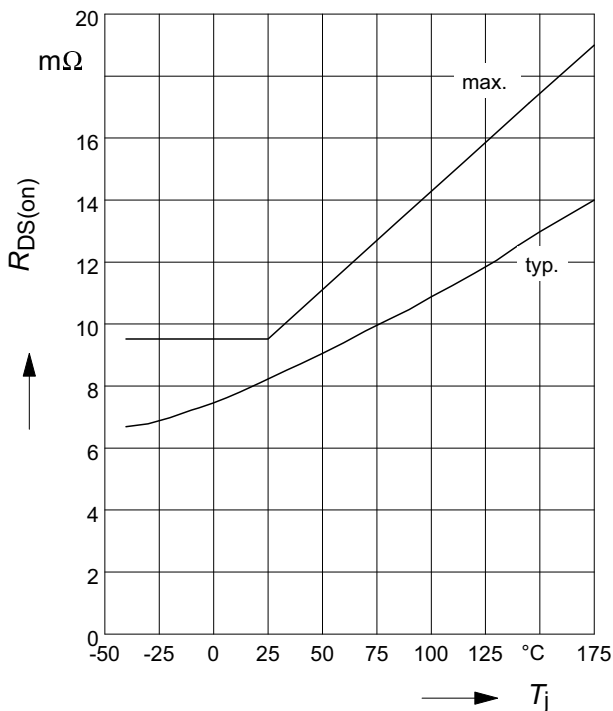

8 On-state resistance

$R_{ON} = f(T_j); I_D=36\text{A}; V_{GS} = 10\text{V}$

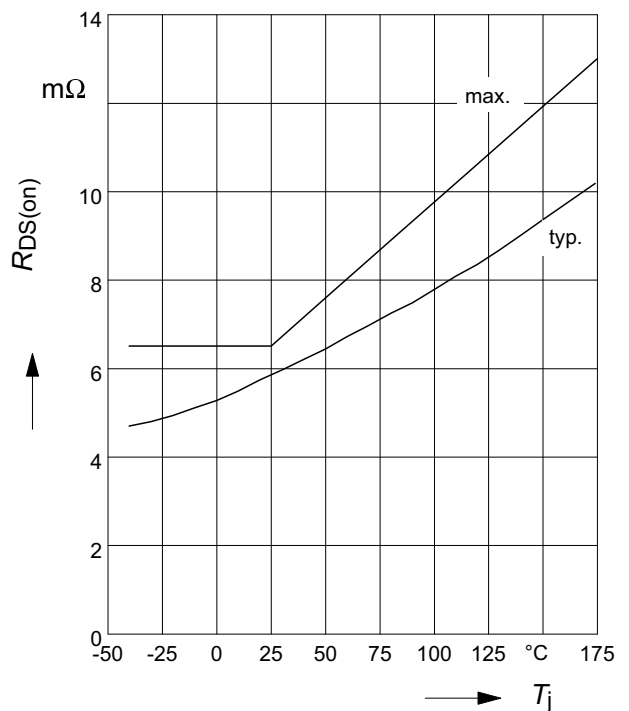

9 Typ. transfer characteristics

$I_D = f(V_{GS}); V_{DS} = 12V; T_j = 25^\circ C$

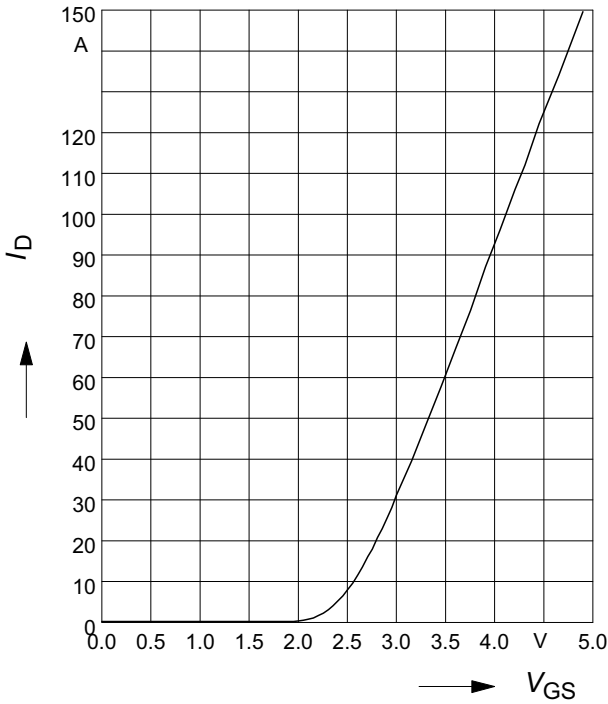

10 Typ. input threshold voltage

$V_{GS(th)} = f(T_j); V_{DS} = V_{GS}$

Parameter: I_D

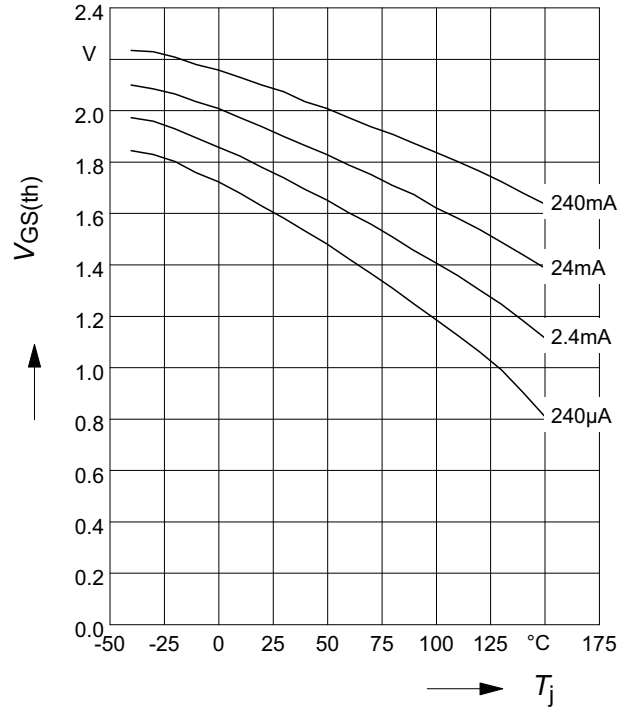

11 Typ. capacitances

$C = f(V_{DS}); V_{GS} = 0V, f = 1MHz$

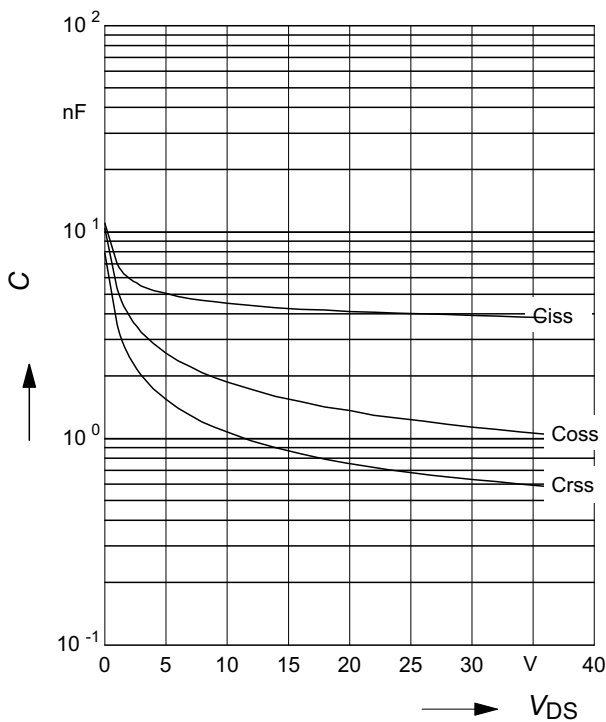

12 Typ. reverse diode forward characteristics

$I_F = f(V_{SD})$

$t_p = 80\mu s$ (spread); Parameter: T_j

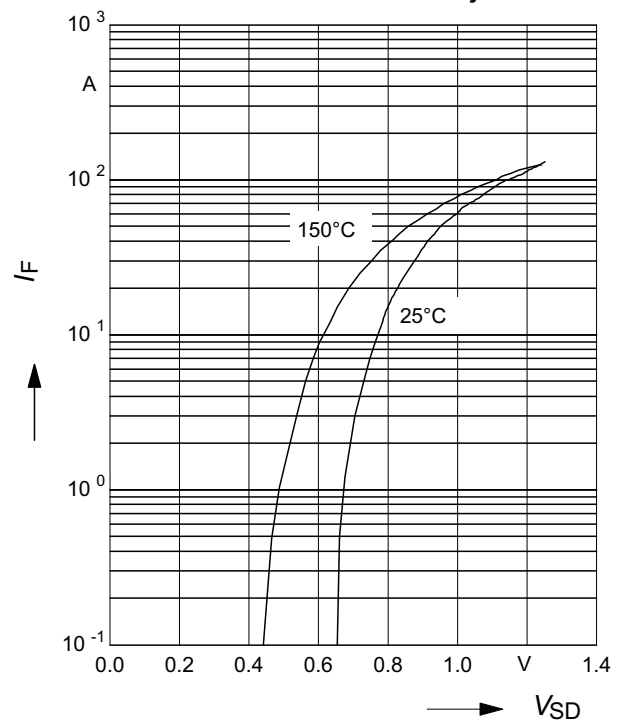

13 Typ. gate charge

$$V_{GS} = f(Q_{Gate})$$

Parameter: $I_{D\ puls} = 80\ A$

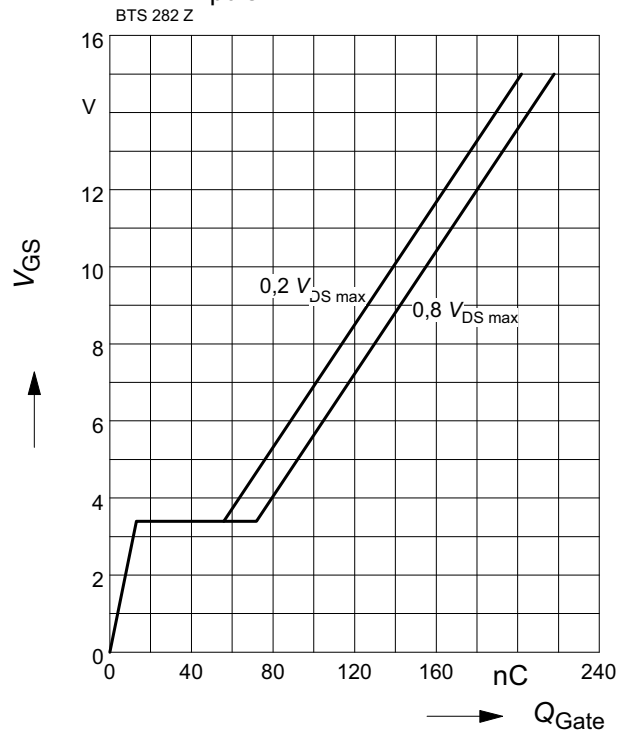

14 Drain-source break down voltage

$$V_{(BR)DSS} = f(T_j)$$

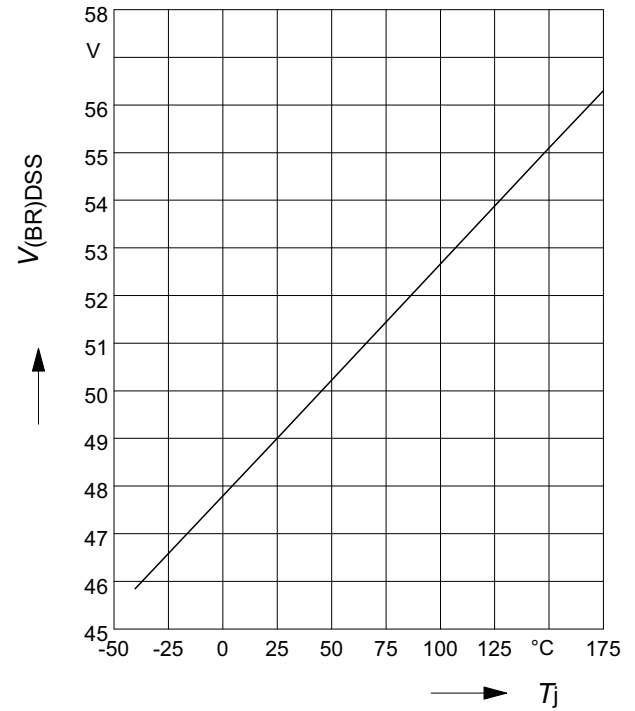

1 Package Outlines

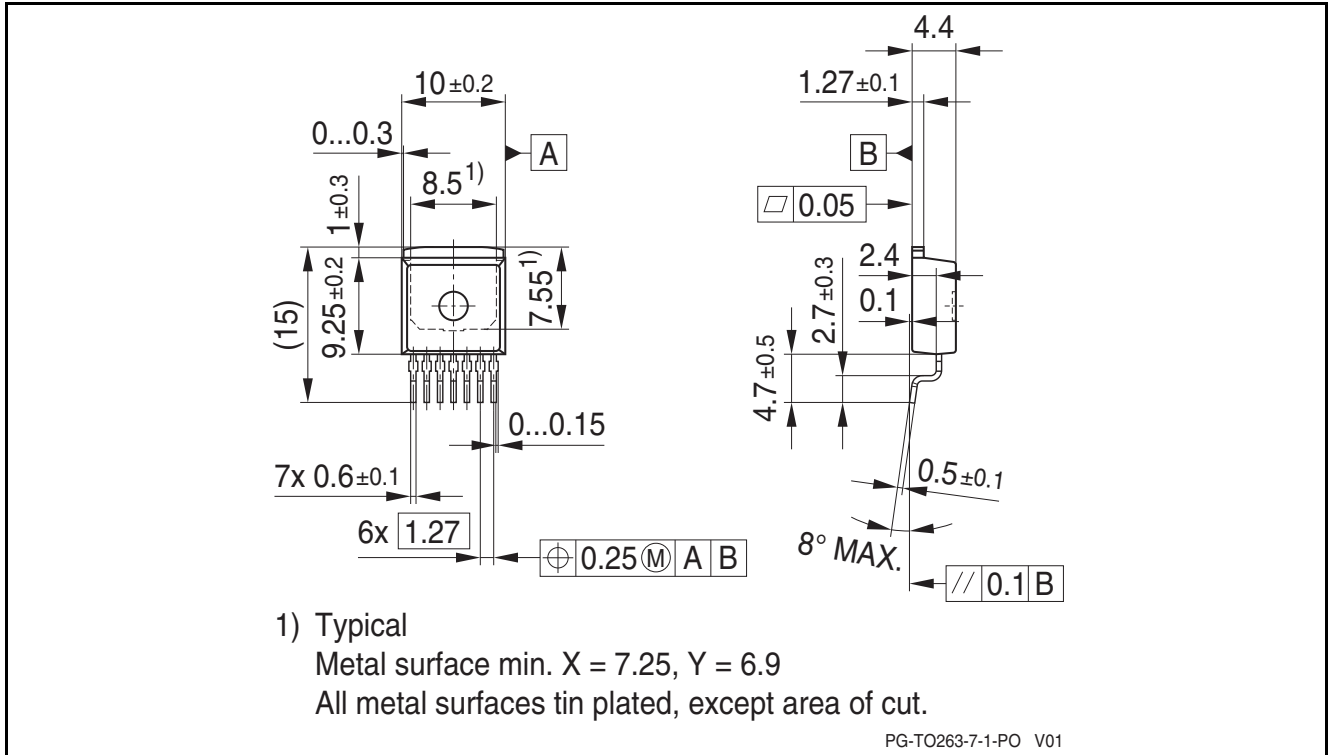

Figure 1 PG-T0263-7-1

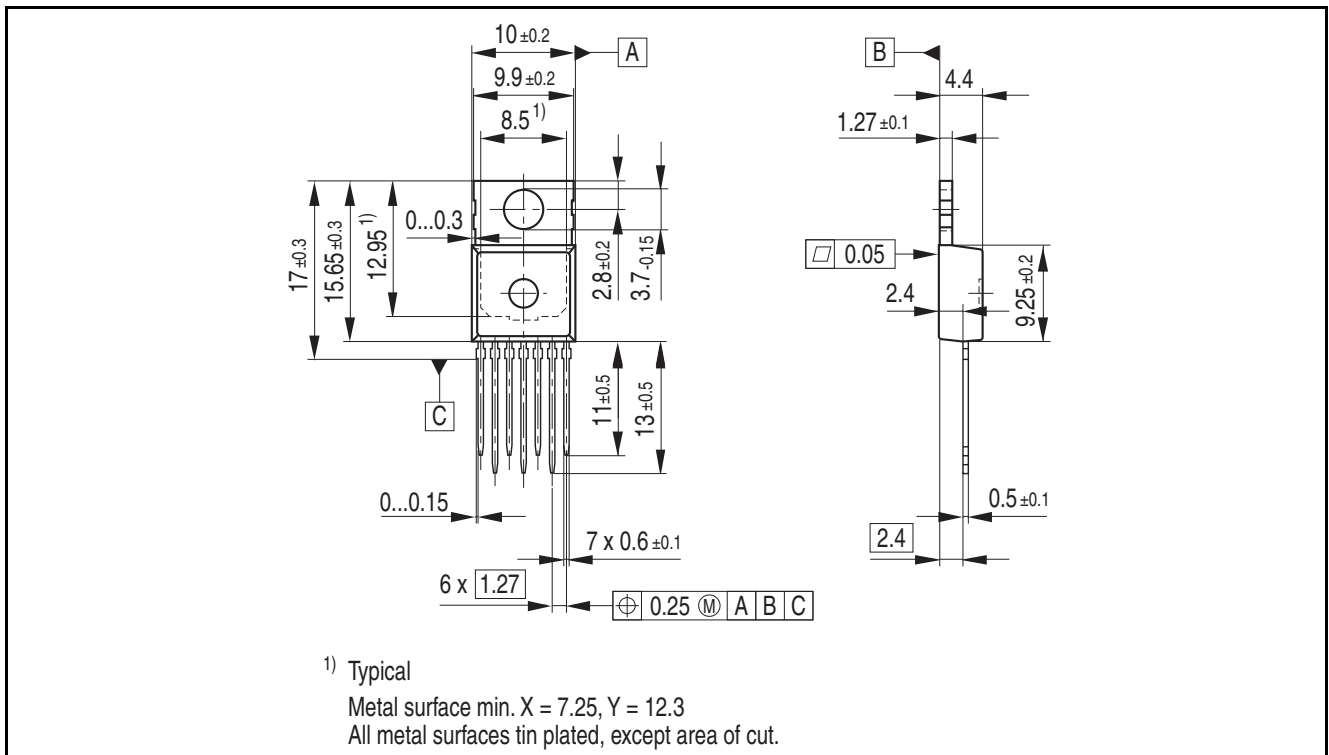

Figure 2 PG-T0220-7-12

Green Product (RoHS compliant)

To meet the world-wide customer requirements for environmentally friendly products and to be compliant with government regulations the device is available as a green product. Green products are RoHS-Compliant (i.e. Pb-free finish on leads and suitable for Pb-free soldering according to IPC/JEDEC J-STD-020).

2 Revision History

Revision	Date	Changes
1.3	2013-07-26	page 1, 11: updated package name and package drawing: PG-TO220-7-180 to PG-TO263-7-1 (SMD) PG-TO220-7-230 to PG-TO220-7-12 (THD, straight leads); page 1, 11/12: removed package PG-TO220-7-3 (THD, staggered leads); page 1: added sales names for the different packages; page 8: updated description figure 5
1.2	2009-07-31	removed 100ms and DC line in SOA diagram
1.1	2008-10-21	all pages: added new Infineon logo Creation of the green datasheet. Initial version of RoHS-compliant derivate of the BTS282Z Page 1 and 12: added RoHS compliance statement and Green product feature Page 1, 11 and 12: Package changed to RoHS compliant version page 13: added Revision history page 14: added Disclaimer

Edition 2013-07-26

**Published by
Infineon Technologies AG
81726 Munich, Germany**

**© 2013 Infineon Technologies AG
All Rights Reserved.**

Legal Disclaimer

The information given in this document shall in no event be regarded as a guarantee of conditions or characteristics. With respect to any examples or hints given herein, any typical values stated herein and/or any information regarding the application of the device, Infineon Technologies hereby disclaims any and all warranties and liabilities of any kind, including without limitation, warranties of non-infringement of intellectual property rights of any third party.

Information

For further information on technology, delivery terms and conditions and prices, please contact the nearest Infineon Technologies Office (www.infineon.com).

Warnings

Due to technical requirements, components may contain dangerous substances. For information on the types in question, please contact the nearest Infineon Technologies Office.

Infineon Technologies components may be used in life-support devices or systems only with the express written approval of Infineon Technologies, if a failure of such components can reasonably be expected to cause the failure of that life-support device or system or to affect the safety or effectiveness of that device or system. Life support devices or systems are intended to be implanted in the human body or to support and/or maintain and sustain and/or protect human life. If they fail, it is reasonable to assume that the health of the user or other persons may be endangered.

Mouser Electronics

Authorized Distributor

Click to View Pricing, Inventory, Delivery & Lifecycle Information:

[Infineon:](#)

[BTS282ZE3180AATMA2](#) [BTS282ZE3230AKSA2](#)