

## AMC1200-Q1 Fully-Differential Isolation Amplifier

### 1 Features

- Qualified for Automotive Applications
- AEC-Q100 Qualified With the Following Results:
  - Temperature Grade 2:  $-40^{\circ}\text{C}$  to  $105^{\circ}\text{C}$
  - HBM ESD Classification Level H2
  - CDM ESD Classification Level C3B
- $\pm 250\text{-mV}$  Input Voltage Range Optimized for Shunt Resistors
- Very Low Nonlinearity: 0.075% (max) with 5-V High-Side Supply
- Low Offset Error: 1.5 mV (max)
- Low Noise: 3.1 mV<sub>RMS</sub> (typical)
- Low High-Side Supply Current: 8 mA (max) at 5 V
- Input Bandwidth: 60 kHz (min)
- Fixed Gain: 8 (0.5% accuracy)
- High Common-Mode Rejection Ratio: 108 dB (typical)
- 3.3-V Operation on Low-Side
- Certified Galvanic Isolation:
  - UL1577 and VDE V 0884-10 Approved
  - Isolation Voltage: 4250 V<sub>PEAK</sub>
  - Working Voltage: 1200 V<sub>PEAK</sub>
  - Transient Immunity: 10 kV/ $\mu\text{s}$  (min)
- Typical 10-Year Lifespan at Rated Working Voltage (see Application Report, [SLLA197](#))

### 2 Applications

- Isolated Shunt-Resistor-Based Current or Voltage Sensing in:
  - Traction Inverters
  - On-Board Chargers
  - DC-DC Converters
  - Battery Management Systems

### 3 Description

The AMC1200-Q1 is a precision isolation amplifier with the output separated from the input circuitry by a silicon dioxide (SiO<sub>2</sub>) barrier that is highly resistant to magnetic interference. This barrier is certified to provide galvanic isolation of up to 4250 V<sub>PEAK</sub> according to UL1577 and VDE V 0884-10. Used in conjunction with isolated power supplies, this device prevents noise currents on a high common-mode voltage line from entering the local ground and interfering with or damaging sensitive circuitry.

The input of the AMC1200-Q1 is optimized for direct connection to shunt resistors or other low-voltage level signal sources. The performance of the device supports accurate current control, resulting in system-level power saving and (especially in motor-control applications) lower torque ripple. The common-mode voltage of the output signal is automatically adjusted to either the 3-V or 5-V low-side supply.

The AMC1200-Q1 is available in a wide-body, 8-pin SOIC package (DWV) and a gullwing, 8-pin SOP package (DUB).

#### Device Information<sup>(1)</sup>

PART NUMBER	PACKAGE	BODY SIZE (NOM)
AMC1200-Q1	SOP (8)	9.50 mm × 6.62 mm
	SOIC (8)	5.85 mm × 7.50 mm

(1) For all available packages, see the orderable addendum at the end of the data sheet.

#### Simplified Schematic

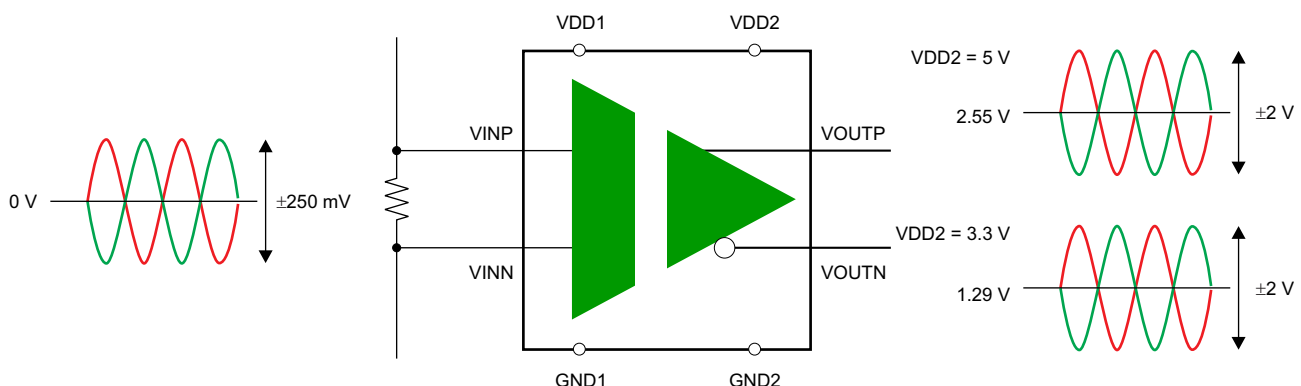

## Table of Contents

<b>1 Features</b> .....	<b>1</b>	7.4 Device Functional Modes.....	<b>14</b>
<b>2 Applications</b> .....	<b>1</b>	<b>8 Application and Implementation</b> .....	<b>15</b>
<b>3 Description</b> .....	<b>1</b>	8.1 Application Information.....	<b>15</b>
<b>4 Revision History</b> .....	<b>2</b>	8.2 Typical Applications .....	<b>15</b>
<b>5 Pin Configurations and Functions</b> .....	<b>3</b>	<b>9 Power Supply Recommendations</b> .....	<b>18</b>
<b>6 Specifications</b> .....	<b>4</b>	<b>10 Layout</b> .....	<b>19</b>
6.1 Absolute Maximum Ratings .....	4	10.1 Layout Guidelines .....	19
6.2 ESD Ratings.....	4	10.2 Layout Example .....	19
6.3 Recommended Operating Conditions.....	4	<b>11 Device and Documentation Support</b> .....	<b>20</b>
6.4 Thermal Information .....	4	11.1 Documentation Support .....	20
6.5 Electrical Characteristics.....	5	11.2 Community Resources.....	20
6.6 Typical Characteristics.....	6	11.3 Trademarks .....	20
<b>7 Detailed Description</b> .....	<b>11</b>	11.4 Electrostatic Discharge Caution.....	20
7.1 Overview .....	11	11.5 Glossary .....	20
7.2 Functional Block Diagram .....	11	<b>12 Mechanical, Packaging, and Orderable Information</b> .....	<b>20</b>
7.3 Feature Description.....	12		

## 4 Revision History

NOTE: Page numbers for previous revisions may differ from page numbers in the current version.

### Changes from Original (September 2012) to Revision A

Page

• Deleted last <i>Features</i> bullet .....	<b>1</b>
• Added front-page image caption, <i>ESD Ratings</i> table, <i>Feature Description</i> section, <i>Device Functional Modes</i> section, <i>Application and Implementation</i> section, <i>Power Supply Recommendations</i> section, <i>Layout</i> section, <i>Device and Documentation Support</i> section, and <i>Mechanical, Packaging, and Orderable Information</i> section.....	<b>1</b>
• Added TI Design .....	<b>1</b>
• Changed front-page graphic .....	<b>1</b>
• Changed <i>Pin Configurations and Functions</i> section: condensed pin out drawing into one because packages have identical pin layout .....	<b>3</b>
• Moved <i>Electrical Characteristics</i> table before <i>Regulatory Information</i> table to comply with latest format .....	<b>5</b>
• Added PSRR to test conditions of Output, <i>PSRR</i> parameter in <i>Electrical Characteristics</i> table .....	<b>5</b>
• Changed CTI parameter in <i>Package Characteristics</i> table: added DWV package row .....	<b>13</b>
• Added sentence to <i>Design Requirements</i> section .....	<b>16</b>

## 5 Pin Configurations and Functions

**DUB and DWV Packages  
8-Pin SOP and SOIC  
Top View**

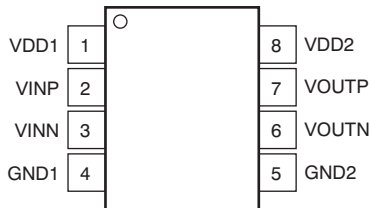

**Pin Functions**

PIN		I/O	DESCRIPTION
NO.	NAME		
1	VDD1	—	High-side power supply, 4.5 V to 5.5 V. See the <a href="#">Power Supply Recommendations</a> section for decoupling recommendations.
2	VINP	I	Noninverting analog input
3	VINN	I	Inverting analog input
4	GND1	—	High-side analog ground
5	GND2	—	Low-side analog ground
6	VOUTN	O	Inverting analog output with self-adjusting, common-mode voltage
7	VOUTP	O	Noninverting analog output with self-adjusting, common-mode voltage
8	VDD2	—	Low-side power supply, 2.7 V to 5.5 V. See the <a href="#">Power Supply Recommendations</a> section for decoupling recommendations.

## 6 Specifications

### 6.1 Absolute Maximum Ratings

over operating ambient temperature range (unless otherwise noted)<sup>(1)</sup>

		MIN	MAX	UNIT
Supply voltage	VDD1 to GND1 or VDD2 to GND2	-0.5	6	V
Input voltage	VINP, VINN	GND1 - 0.5	VDD1 + 0.5	V
Input current	VINP, VINN, VOUTP, VOUTN	-10	10	mA
Junction temperature, T <sub>J</sub>		-40	150	°C
Storage temperature, T <sub>stg</sub>		-65	150	°C

(1) Stresses beyond those listed under *Absolute Maximum Ratings* may cause permanent damage to the device. These are stress ratings only, and functional operation of the device at these or any other conditions beyond those indicated is not implied. Exposure to absolute maximum rated conditions for extended periods may affect device reliability.

### 6.2 ESD Ratings

			VALUE	UNIT
V <sub>(ESD)</sub>	Electrostatic discharge	Human-body model (HBM), per AEC-Q100, Classification Level H2 <sup>(1)</sup>	±2500	V
		Charged-device model (CDM), per AEC-Q100, Classification Level C3B <sup>(2)</sup>	±1000	

(1) JEDEC document JEP155 states that 500-V HBM allows safe manufacturing with a standard ESD control process.

(2) JEDEC document JEP157 states that 250-V CDM allows safe manufacturing with a standard ESD control process.

### 6.3 Recommended Operating Conditions

over operating ambient temperature range (unless otherwise noted)

		MIN	NOM	MAX	UNIT
VDD1	High-side supply voltage	4.5	5	5.5	V
VDD2	Low-side supply voltage	2.7	5	5.5	V
V <sub>VINP</sub> , V <sub>VINN</sub>	Absolute input voltage	GND1 - 0.32		VDD1 + 0.16	V
V <sub>IN</sub>	Differential input voltage	V <sub>VINP</sub> - V <sub>VINN</sub>		250	mV
V <sub>CM</sub>	Common-mode input voltage	(V <sub>VINP</sub> + V <sub>VINN</sub> ) / 2		VDD1	V
T <sub>A</sub>	Operating ambient temperature	-40	25	105	°C

### 6.4 Thermal Information

THERMAL METRIC <sup>(1)</sup>		AMC1200-Q1		UNIT
		DUB (SOP)	DWV (SOIC)	
		8 PINS	8 PINS	
R <sub>θJA</sub>	Junction-to-ambient thermal resistance	75.1	102.8	°C/W
R <sub>θJC(top)</sub>	Junction-to-case (top) thermal resistance	61.6	49.8	°C/W
R <sub>θJB</sub>	Junction-to-board thermal resistance	39.8	56.6	°C/W
ψ <sub>JT</sub>	Junction-to-top characterization parameter	27.2	16	°C/W
ψ <sub>JB</sub>	Junction-to-board characterization parameter	39.4	55.2	°C/W

(1) For more information about traditional and new thermal metrics, see the *Semiconductor and IC Package Thermal Metrics* application report, [SPRA953](#).

## 6.5 Electrical Characteristics

Minimum and maximum specifications are at  $T_A = -40^\circ\text{C}$  to  $+105^\circ\text{C}$ ,  $V_{DD1} = 4.5\text{ V}$  to  $5.5\text{ V}$ , and  $V_{DD2} = 2.7\text{ V}$  to  $5.5\text{ V}$ . Typical specifications are at  $T_A = 25^\circ\text{C}$ ,  $V_{DD1} = 5\text{ V}$ , and  $V_{DD2} = 3.3\text{ V}$  (unless otherwise noted).

PARAMETER		TEST CONDITIONS	MIN	TYP	MAX	UNIT
<b>INPUT</b>						
$V_{\text{Clipping}}$	Input voltage with clipping output	$V_{\text{VINP}} - V_{\text{VINN}}$		$\pm 320$		mV
$V_{\text{IO}}$	Input offset voltage		-1.5	$\pm 0.2$	1.5	mV
	Input offset thermal drift		-10	$\pm 1.5$	10	$\mu\text{V}/^\circ\text{C}$
CMRR	Common-mode rejection ratio	$V_{\text{IN}}$ from 0 V to 5 V at 0 Hz		108		dB
		$V_{\text{IN}}$ from 0 V to 5 V at 50 kHz		95		
$C_1$	Input capacitance	VINP to GND1 or VINN to GND1		3		pF
$C_{\text{ID}}$	Differential input capacitance			3.6		pF
$R_{\text{ID}}$	Differential input resistance			28		k $\Omega$
	Small-signal bandwidth		60	100		kHz
<b>OUTPUT</b>						
G	Nominal gain			8		
$E_G$	Gain error	Initial, $T_A = 25^\circ\text{C}$	-0.5%	$\pm 0.05\%$	0.5%	
			-1%	$\pm 0.05\%$	1%	
	Gain error thermal drift			$\pm 56$		ppm/ $^\circ\text{C}$
	Nonlinearity	$4.5\text{ V} \leq V_{\text{DD2}} \leq 5.5\text{ V}$	-0.075%	$\pm 0.015\%$	0.075%	
		$2.7\text{ V} \leq V_{\text{DD2}} \leq 3.6\text{ V}$	-0.1%	$\pm 0.023\%$	0.1%	
	Nonlinearity thermal drift			2.4		ppm/ $^\circ\text{C}$
	Output noise	$V_{\text{VINP}} = V_{\text{VINN}} = 0\text{ V}$		3.1		mV <sub>RMS</sub>
PSRR	Power-supply rejection ratio	PSRR vs VDD1, 10-kHz ripple		80		dB
		PSRR vs VDD2, 10-kHz ripple		61		
	Rise and fall time	0.5-V step, 10% to 90%		3.66	6.6	$\mu\text{s}$
	$V_{\text{IN}}$ to $V_{\text{OUT}}$ signal delay	0.5-V step, 50% to 10%, unfiltered output		1.6	3.3	$\mu\text{s}$
		0.5-V step, 50% to 50%, unfiltered output		3.15	5.6	
		0.5-V step, 50% to 90%, unfiltered output		5.26	9.9	
CMTI	Common-mode transient immunity	$V_{\text{CM}} = 1\text{ kV}$ , $T_A = 25^\circ\text{C}$	8	15		kV/ $\mu\text{s}$
		Output common-mode voltage	$2.7\text{ V} \leq V_{\text{DD2}} \leq 3.6\text{ V}$	1.15	1.29	1.45
		$4.5\text{ V} \leq V_{\text{DD2}} \leq 5.5\text{ V}$	2.4	2.55	2.7	
	Short-circuit current			20		mA
$R_O$	Output resistance			2.5		$\Omega$
<b>POWER SUPPLY</b>						
$I_{\text{DD1}}$	High-side supply current			5.4	8	mA
$I_{\text{DD2}}$	Low-side supply current	$2.7\text{ V} \leq V_{\text{DD2}} \leq 3.6\text{ V}$		3.8	6	mA
		$4.5\text{ V} \leq V_{\text{DD2}} \leq 5.5\text{ V}$		4.4	7	
$P_{\text{DD1}}$	High-side power dissipation			27	44	mW
$P_{\text{DD2}}$	Low-side power dissipation	$2.7\text{ V} \leq V_{\text{DD2}} \leq 3.6\text{ V}$		11.4	21.6	mW
		$4.5\text{ V} \leq V_{\text{DD2}} \leq 5.5\text{ V}$		22	38.5	

# AMC1200-Q1

SBAS585A – SEPTEMBER 2012 – REVISED JANUARY 2016

www.ti.com

## 6.6 Typical Characteristics

$T_A = 25^\circ\text{C}$ ,  $V_{DD1} = V_{DD2} = 5\text{ V}$ ,  $V_{VINP} = -250\text{ mV}$  to  $250\text{ mV}$ , and  $V_{VINN} = 0\text{ V}$  (unless otherwise noted)

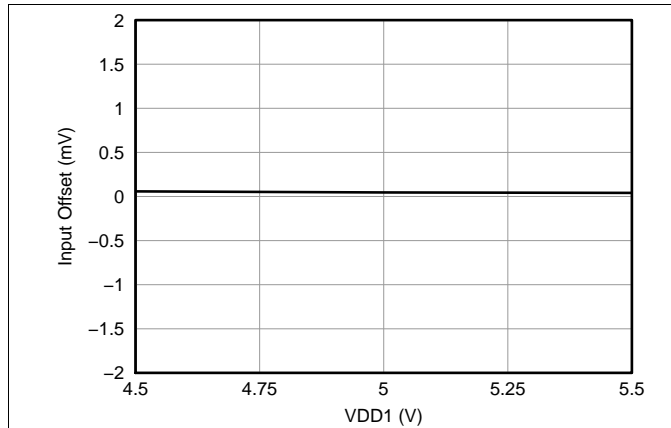

Figure 1. Input Offset vs High-Side Supply Voltage

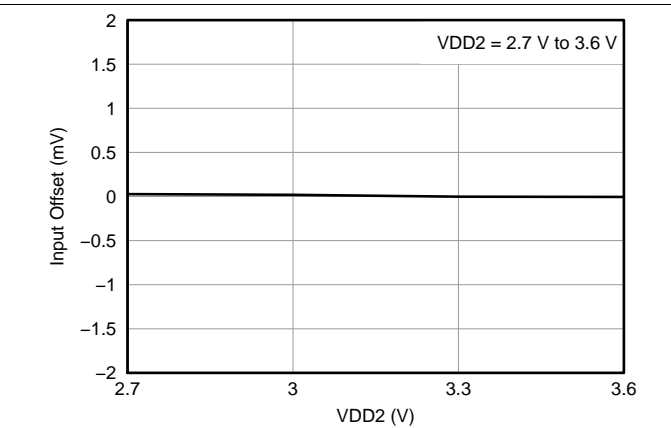

Figure 2. Input Offset vs Low-Side Supply Voltage

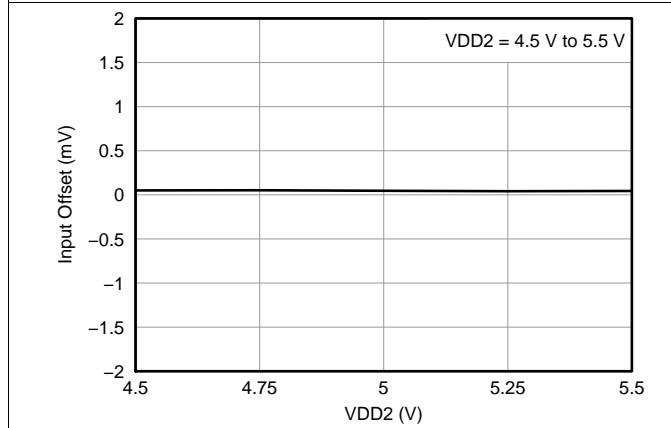

Figure 3. Input Offset vs Low-Side Supply Voltage

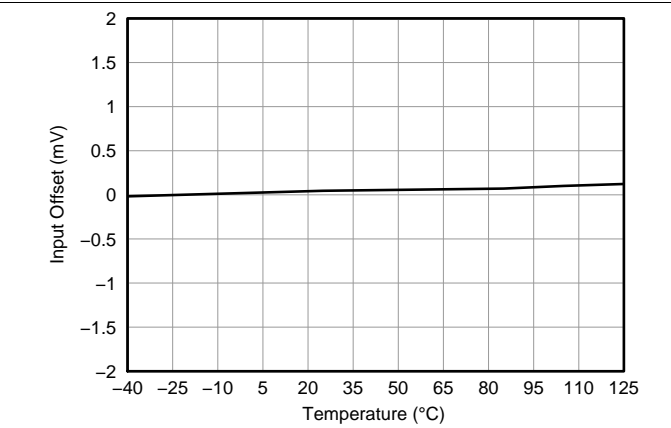

Figure 4. Input Offset vs Temperature

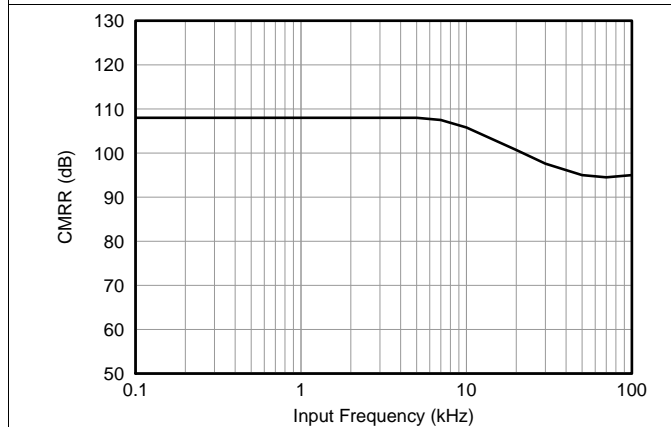

Figure 5. Common-Mode Rejection Ratio vs Input Frequency

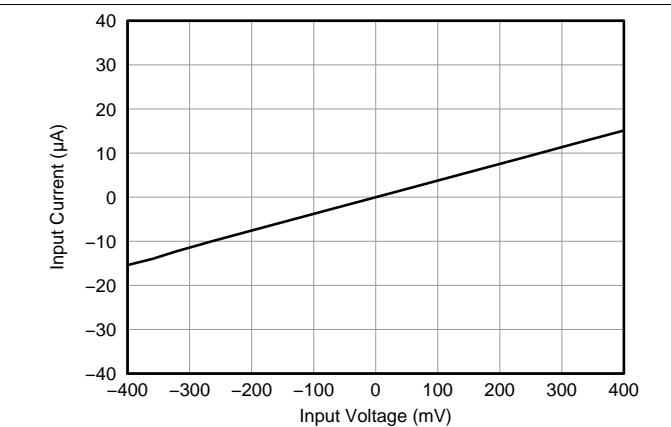

Figure 6. Input Current vs Input Voltage

Typical Characteristics (continued)

$T_A = 25^\circ\text{C}$ ,  $V_{DD1} = V_{DD2} = 5\text{ V}$ ,  $V_{VINP} = -250\text{ mV}$  to  $250\text{ mV}$ , and  $V_{VINN} = 0\text{ V}$  (unless otherwise noted)

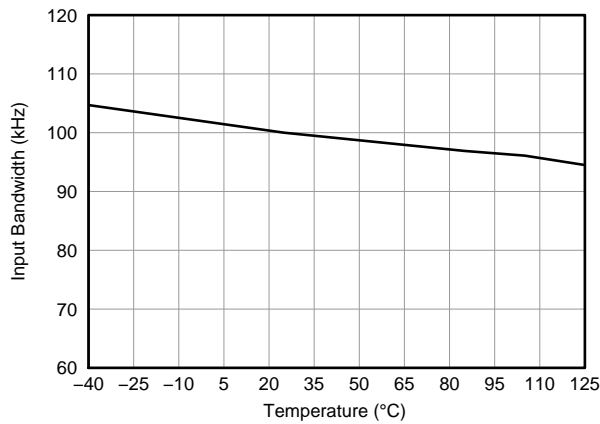

Figure 7. Input Bandwidth vs Temperature

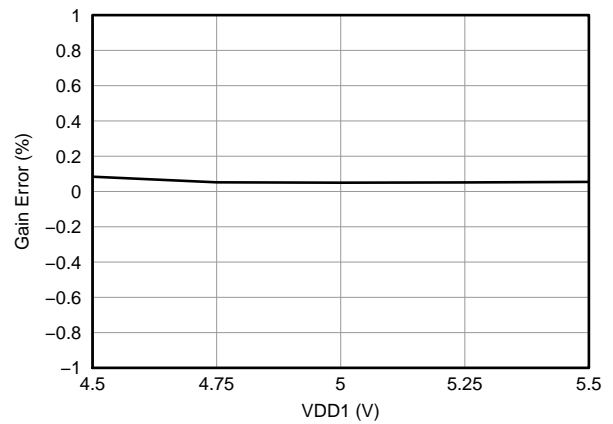

Figure 8. Gain Error vs High-Side Supply Voltage

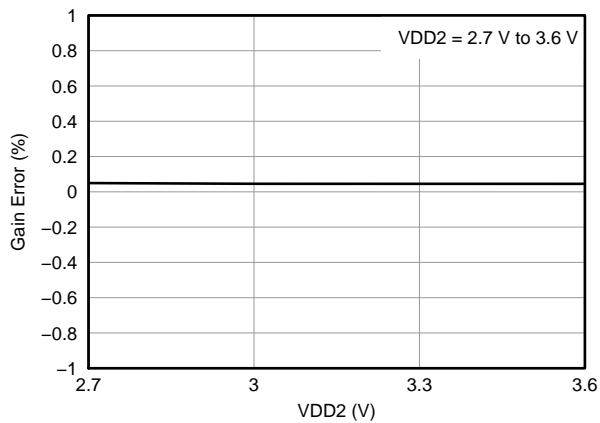

Figure 9. Gain Error vs Low-Side Supply Voltage

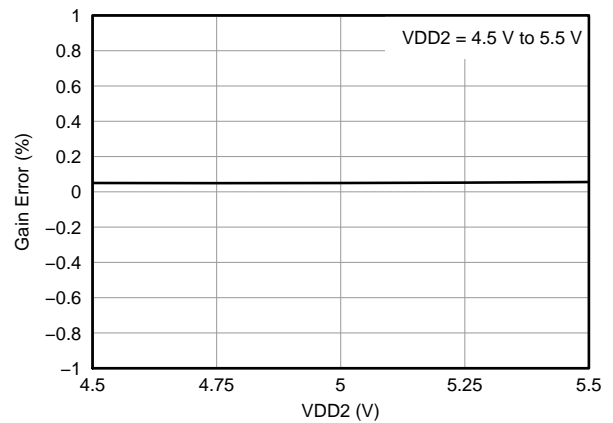

Figure 10. Gain Error vs Low-Side Supply Voltage

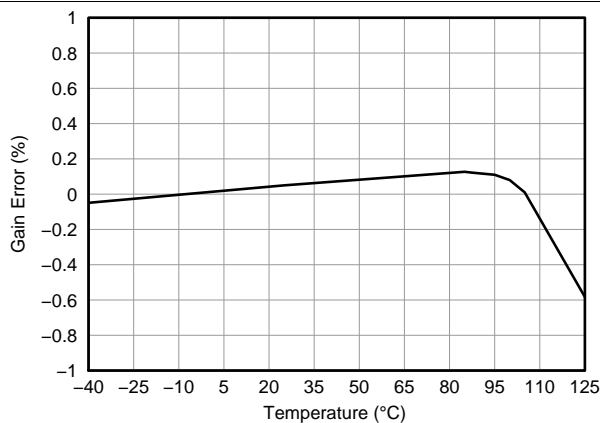

Figure 11. Gain Error vs Temperature

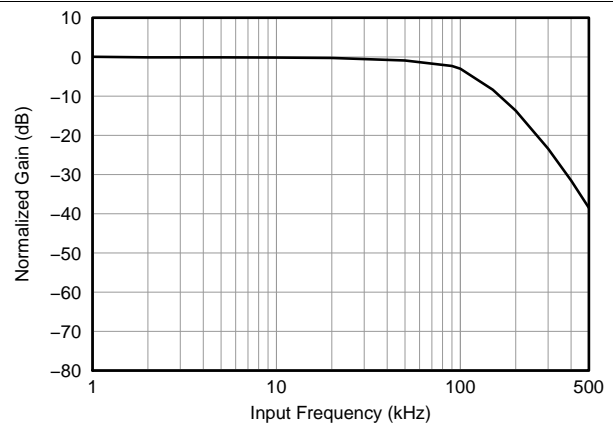

Figure 12. Normalized Gain vs Input Frequency

Typical Characteristics (continued)

$T_A = 25^\circ\text{C}$ ,  $V_{DD1} = V_{DD2} = 5\text{ V}$ ,  $V_{VINP} = -250\text{ mV}$  to  $250\text{ mV}$ , and  $V_{VINN} = 0\text{ V}$  (unless otherwise noted)

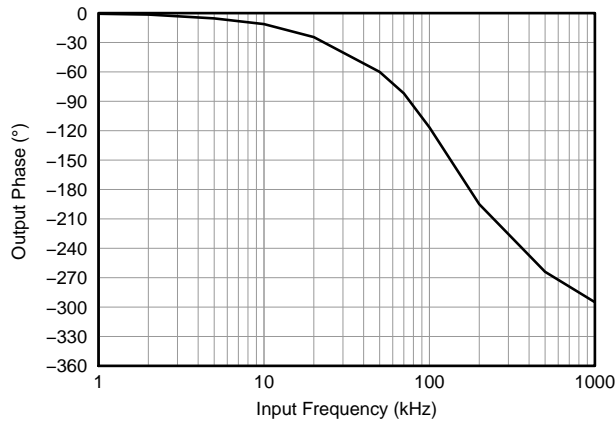

Figure 13. Output Phase vs Input Frequency

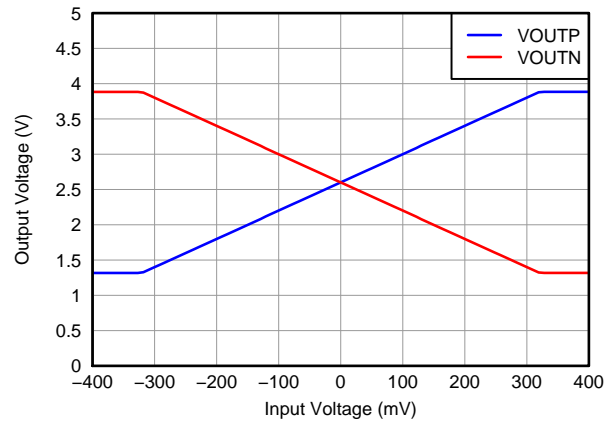

Figure 14. Output Voltage vs Input Voltage

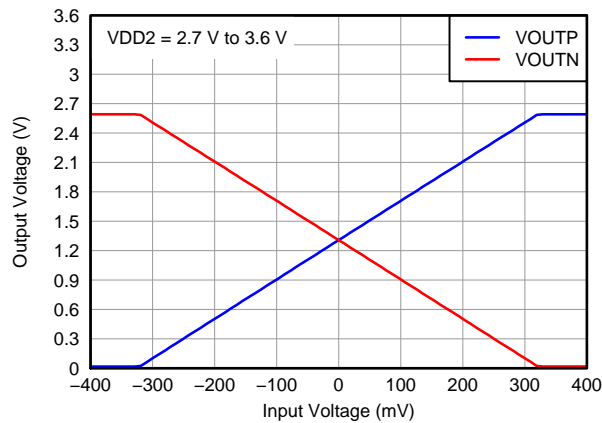

Figure 15. Output Voltage vs Input Voltage

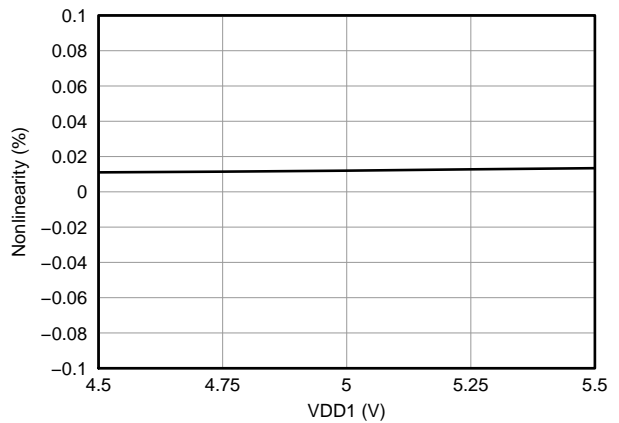

Figure 16. Nonlinearity vs High-Side Supply Voltage

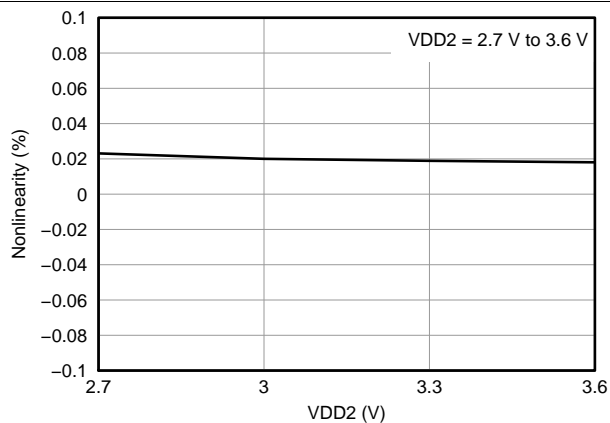

Figure 17. Nonlinearity vs Low-Side Supply Voltage

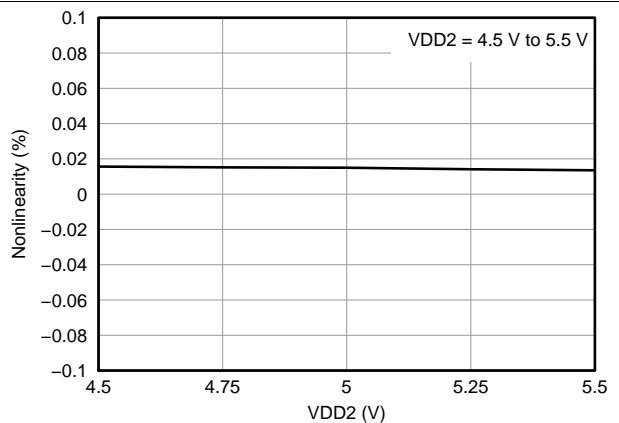

Figure 18. Nonlinearity vs Low-Side Supply Voltage



Typical Characteristics (continued)

$T_A = 25^\circ\text{C}$ ,  $V_{DD1} = V_{DD2} = 5\text{ V}$ ,  $V_{VINP} = -250\text{ mV}$  to  $250\text{ mV}$ , and  $V_{VINN} = 0\text{ V}$  (unless otherwise noted)

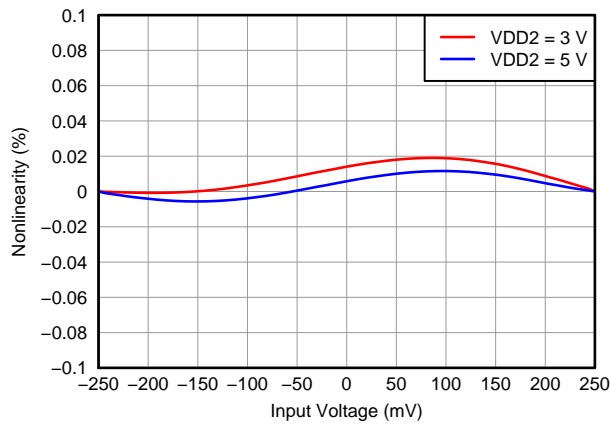

Figure 19. Nonlinearity vs Input Voltage

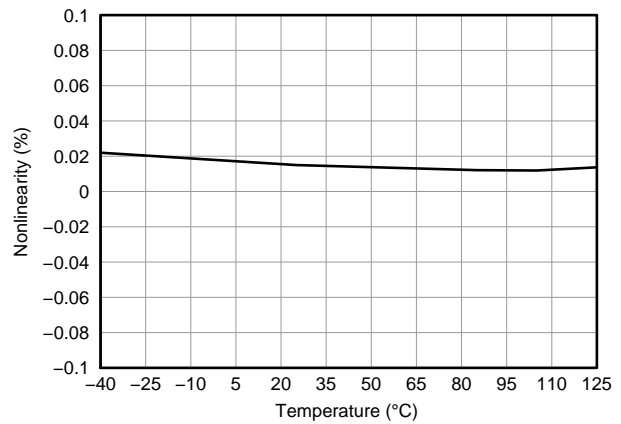

Figure 20. Nonlinearity vs Temperature

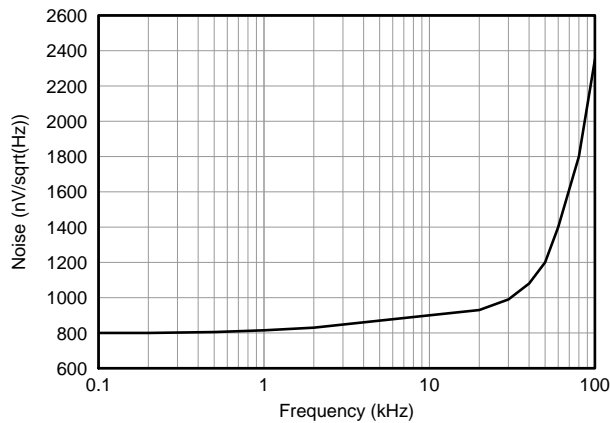

Figure 21. Output Noise Density vs Frequency

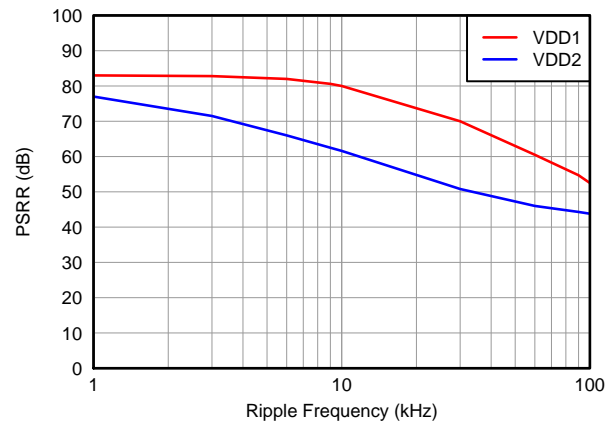

Figure 22. Power-Supply Rejection Ratio vs Ripple Frequency

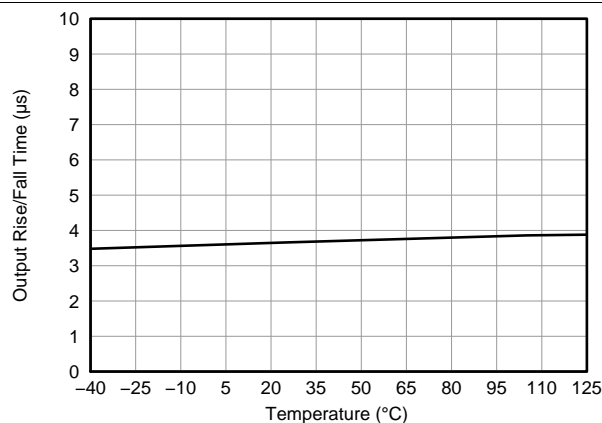

Figure 23. Output Rise and Fall Time vs Temperature

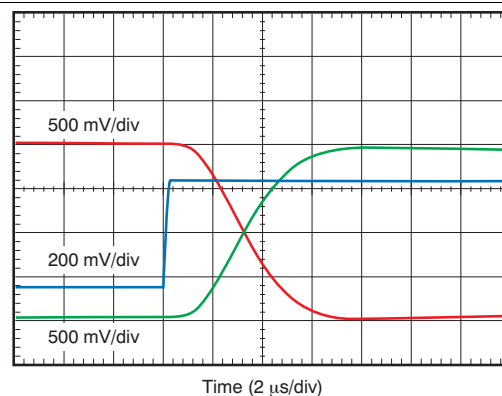

Figure 24. Full-Scale Step Response

Typical Characteristics (continued)

$T_A = 25^\circ\text{C}$ ,  $V_{DD1} = V_{DD2} = 5\text{ V}$ ,  $V_{VINP} = -250\text{ mV to }250\text{ mV}$ , and  $V_{VINN} = 0\text{ V}$  (unless otherwise noted)

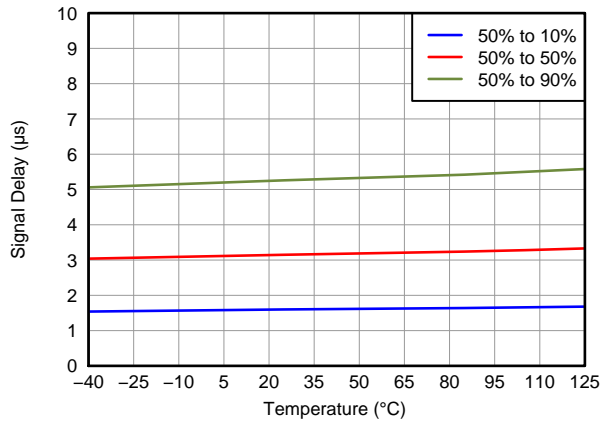

Figure 25. Output Signal Delay Time vs Temperature

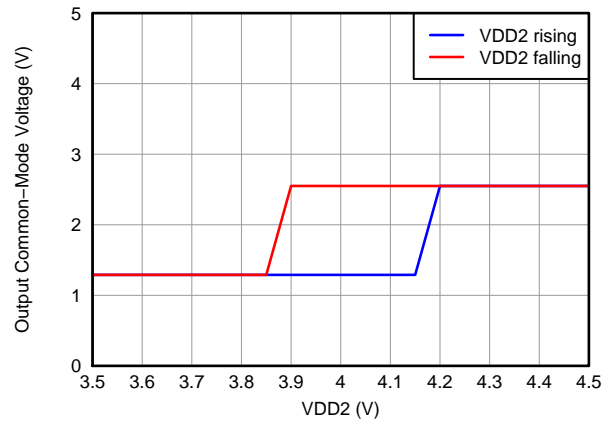

Figure 26. Output Common-Mode Voltage vs Low-Side Supply Voltage

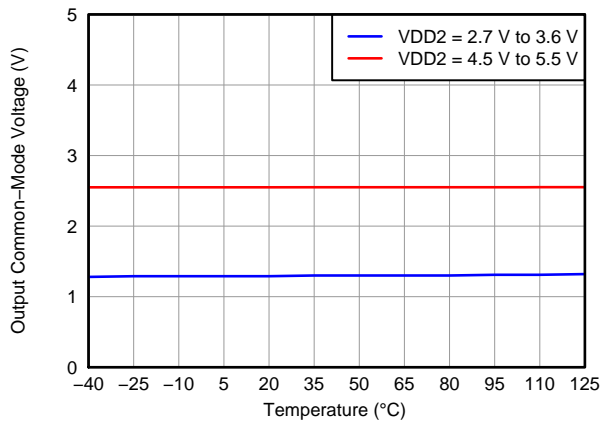

Figure 27. Output Common-Mode Voltage vs Temperature

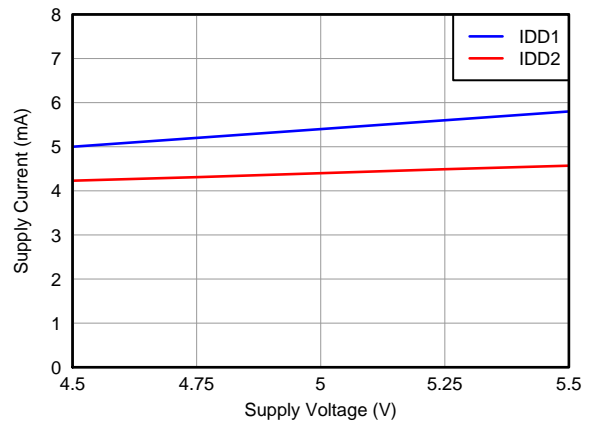

Figure 28. Supply Current vs Supply Voltage

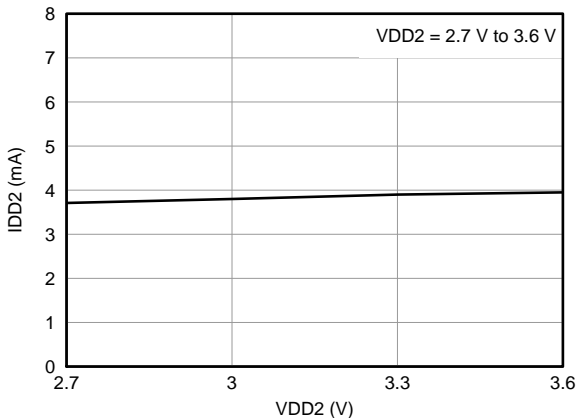

Figure 29. Low-Side Supply Current vs Low-Side Supply Voltage

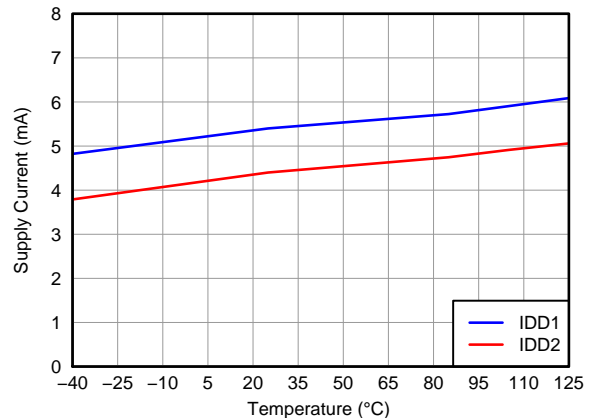

Figure 30. Supply Current vs Temperature

## 7 Detailed Description

### 7.1 Overview

The AMC1200-Q1 is a fully-differential precision isolation amplifier. The input stage of the device consists of a second-order, delta-sigma ( $\Delta\Sigma$ ) modulator, voltage reference, clock generator, and drivers for the capacitive isolation barrier. The modulator converts the analog input signal to the digital domain. The drivers transfer the output of the modulator and the clock signal across the isolation barrier that separates the high- and low-voltage domains. The received bitstream and clock signals are synchronized and processed by a third-order analog filter with a nominal gain of 8 on the low-side and presented as a differential output of the device, as shown in the [Functional Block Diagram](#) section.

The SiO<sub>2</sub>-based capacitive isolation barrier supports a high level of magnetic field immunity, as described in application report, [ISO72x Digital Isolator Magnetic-Field Immunity \(SLLA181\)](#). The digital modulation used in the AMC1200-Q1 and the isolation barrier characteristics result in high reliability and common-mode transient immunity.

### 7.2 Functional Block Diagram

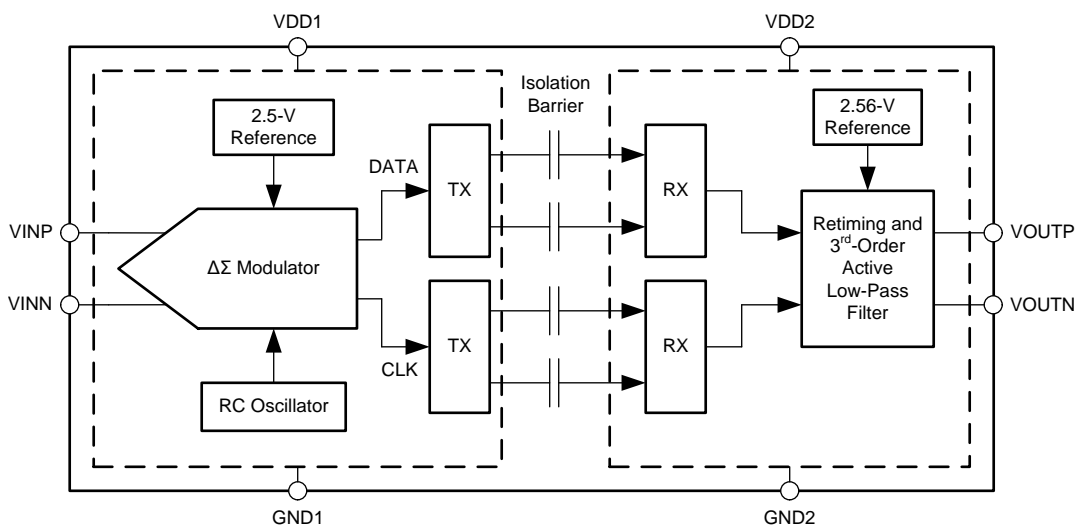

## 7.3 Feature Description

### 7.3.1 Insulation Characteristics

over recommended operating conditions (unless otherwise noted)

PARAMETER		TEST CONDITIONS	MIN	TYP	MAX	UNIT
$V_{IORM}$	Maximum working insulation voltage				1200	$V_{PEAK}$
$V_{PR}$	Input to output test voltage	Qualification test: after input/output safety test subgroup 2/3, $V_{PR} = V_{IORM} \times 1.2$ , $t = 10$ s, partial discharge < 5 pC			1440	$V_{PEAK}$
		Qualification test: method a, after environmental tests subgroup 1, $V_{PR} = V_{IORM} \times 1.6$ , $t = 10$ s, partial discharge < 5 pC			1920	
		100% production test: method b1, $V_{PR} = V_{IORM} \times 1.875$ , $t = 1$ s, partial discharge < 5 pC			2250	
$V_{IOTM}$	Transient overvoltage	Qualification test: $t = 60$ s			4250	$V_{PEAK}$
$V_{ISO}$	Insulation voltage per UL	Qualification test: $V_{TEST} = V_{ISO}$ , $t = 60$ s			4250	$V_{PEAK}$
		100% production test: $V_{TEST} = 1.2 \times V_{ISO}$ , $t = 1$ s			5100	
$R_S$	Insulation resistance	$V_{IO} = 500$ V at $T_S$		> $10^9$		$\Omega$
PD	Pollution degree			2		

**Table 1. IEC 61000-4-5 Ratings**

PARAMETER	TEST CONDITIONS	VALUE	UNIT
Surge immunity	1.2- $\mu$ s and 50- $\mu$ s voltage surge or 8- $\mu$ s and 20- $\mu$ s current surge	$\pm 6000$	V

**Table 2. IEC 60664-1 Ratings**

PARAMETER	TEST CONDITIONS	SPECIFICATION
Basic isolation group	Material group	II
Installation classification	Rated mains voltage $\leq 150$ $V_{RMS}$	I-IV
	Rated mains voltage $\leq 300$ $V_{RMS}$	I-IV
	Rated mains voltage $\leq 400$ $V_{RMS}$	I-III
	Rated mains voltage < 600 $V_{RMS}$	I-III

### 7.3.2 IEC Safety Limiting Values

Safety limiting intends to minimize potential damage to the isolation barrier upon failure of input or output (I/O) circuitry. A failure of the I/O circuitry can cause low resistance to ground or the supply and, without current limiting, dissipate sufficient power to overheat the die and damage the isolation barrier, potentially leading to secondary system failures.

PARAMETER		TEST CONDITIONS	MIN	TYP	MAX	UNIT
$I_S$	Safety input, output, or supply current	$\theta_{JA} = 246^\circ\text{C/W}$ , $V_{IN} = 5.5$ V, $T_J = 150^\circ\text{C}$ , $T_A = 25^\circ\text{C}$	-10		10	mA
$T_C$	Maximum case temperature				150	$^\circ\text{C}$

The safety-limiting constraint is the maximum junction temperature specified in the [Absolute Maximum Ratings](#) table. The power dissipation and junction-to-air thermal impedance of the device installed in the application hardware determine the junction temperature. The assumed junction-to-air thermal resistance in the [Thermal Information](#) table is that of a device installed in the JESD51-3, *Low Effective Thermal Conductivity Test Board for Leaded Surface Mount Packages* and is conservative. The power is the recommended maximum input voltage times the current. The junction temperature is then the ambient temperature plus the power times the junction-to-air thermal resistance.

### 7.3.3 Package Characteristics

Creepage and clearance requirements should be applied according to the specific equipment isolation standards of a specific application. Take care to maintain the creepage and clearance distance of the board design to ensure that the mounting pads of the isolator on the printed-circuit-board (PCB) do not reduce this distance. Creepage and clearance on a PCB become equal according to the measurement techniques shown in the [TI Isolation Glossary](#). Techniques such as inserting grooves and/or ribs on the PCB are used to help increase these specifications.

PARAMETER		TEST CONDITIONS		MIN	TYP	MAX	UNIT
L(I01)	Minimum air gap (clearance)	Shortest pin-to-pin distance through air	DWV package	8			mm
			DUB package	7			
L(I02)	Minimum external tracking (creepage)	Shortest pin-to-pin distance across the package surface	DWV package	8			mm
			DUB package	7			
CTI	Tracking resistance (comparative tracking index)	DIN IEC 60112/VDE 0303 part 1	DWV package	600			V
			DUB package	400			
	Minimum internal gap (internal clearance)	Distance through the insulation		0.014			mm
R <sub>IO</sub>	Isolation resistance	Input to output, V <sub>IO</sub> = 500 V, all pins on each side of the barrier tied together to create a two-pin device, T <sub>A</sub> < 85°C			> 10 <sup>12</sup>		Ω
		Input to output, V <sub>IO</sub> = 500 V, 85°C ≤ T <sub>A</sub> < T <sub>A</sub> max			> 10 <sup>11</sup>		
C <sub>IO</sub>	Barrier capacitance input to output	V <sub>I</sub> = 0.5 V <sub>PP</sub> at 1 MHz			1.2		pF
C <sub>I</sub>	Input capacitance to ground	V <sub>I</sub> = 0.5 V <sub>PP</sub> at 1 MHz			3		pF

### 7.3.4 Regulatory Information

VDE/IEC	UL
Certified according to VDE V 0884-10	Recognized under 1577 component recognition program
Certificate number: 40016131	File number: E181974

### 7.3.5 Analog Input

The analog input voltage range ( $V_{IN} = V_{VINP} - V_{VINN}$ ) is tailored to directly accommodate a voltage drop across a shunt resistor used for current sensing. Note that there are two restrictions on the analog input signals. If the absolute input voltage on either VINP or VINN exceeds the absolute maximum range of  $GND1 - 0.5\text{ V}$  to  $VDD1 + 0.5\text{ V}$ , the input current must be limited to 10 mA to prevent damage of the integrated input protection diodes. In addition, the linearity and the noise performance of the device are ensured only when the differential analog input voltage remains within  $\pm 250\text{ mV}$ .

The differential analog input of the AMC1200-Q1 is a switched-capacitor circuit based on a second-order modulator stage that digitizes the input signal into a 1-bit output stream. The device compares the differential input signal  $V_{IN}$  against the internal 2.5-V reference using internal capacitors that are continuously charged and discharged with a typical frequency of 10 MHz. With the S1 switches closed,  $C_{ID}$  charges to the voltage difference across VINP and VINN. For the discharge phase, both S1 switches open first and then both S2 switches close.  $C_{ID}$  discharges to approximately  $GND1 + 0.8\text{ V}$  during this phase. [Figure 31](#) shows the simplified equivalent input circuitry.

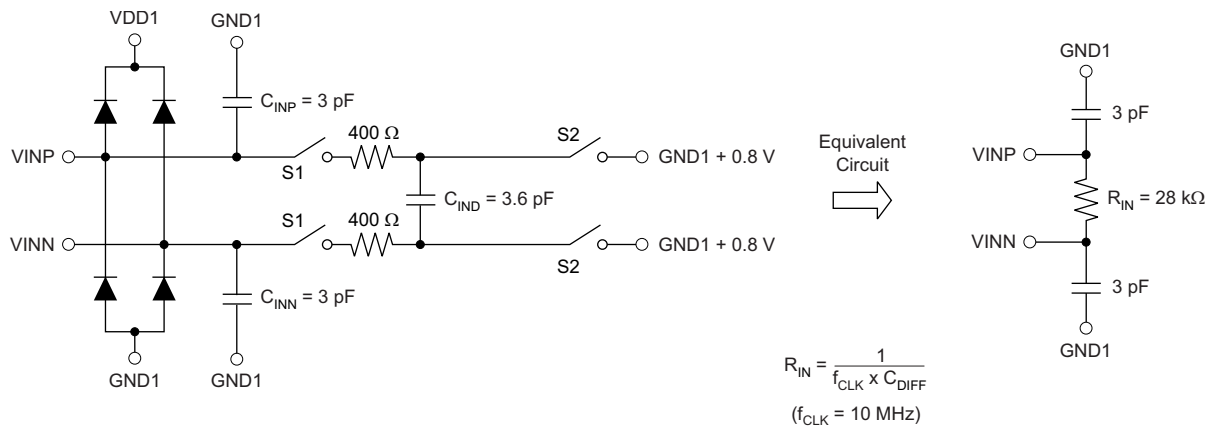

**Figure 31. Equivalent Input Circuit**

### 7.4 Device Functional Modes

The AMC1200-Q1 is operational when the power supplies VDD1 and VDD2 are applied as specified in the [Recommended Operating Conditions](#) section. The AMC1200-Q1 does not have any additional functional modes.

## 8 Application and Implementation

### NOTE

Information in the following applications sections is not part of the TI component specification, and TI does not warrant its accuracy or completeness. TI's customers are responsible for determining suitability of components for their purposes. Customers should validate and test their design implementation to confirm system functionality.

### 8.1 Application Information

The AMC1200-Q1 offers unique linearity, high input common-mode rejection, low dc errors, and low temperature drift. These features make the AMC1200-Q1 a robust, high-performance isolation amplifier for automotive applications where high voltage isolation is required.

### 8.2 Typical Applications

#### 8.2.1 Traction Inverter

Figure 32 shows a typical operation of the AMC1200-Q1 for current sensing in a traction inverter application. Measurement of the phase current is done through the shunt resistor,  $R_{SHUNT}$  (in this case, a two-pin shunt). The differential input and the high common-mode transient immunity of the AMC1200-Q1 ensure reliable and accurate operation even in high-noise environments (such as the power stage of the traction inverter).

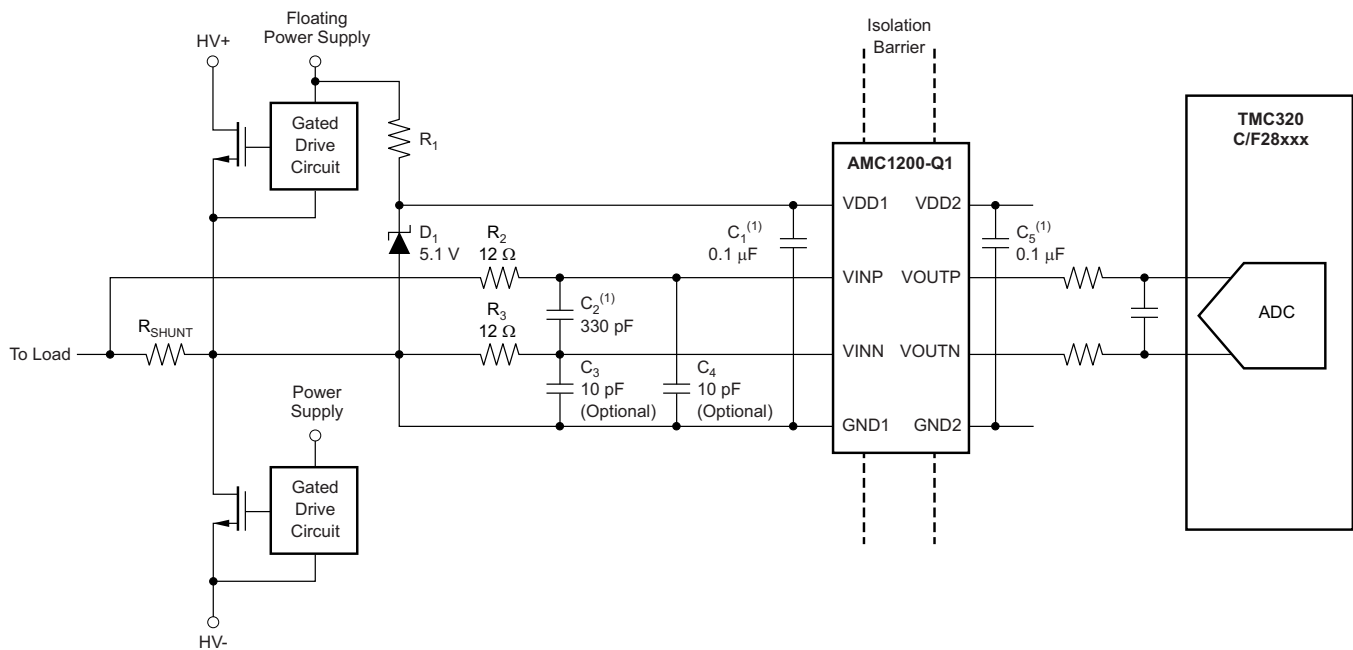

(1) Place these capacitors as close as possible to the AMC1200-Q1.

Figure 32. Typical Application Diagram

Additionally, the AMC1200-Q1 can also be used for isolated voltage measurement of the dc-link as described in the [Isolated Voltage Measurement](#) section.

## Typical Applications (continued)

### 8.2.1.1 Design Requirements

Table 3 lists the parameters for the typical application in Figure 32.

**Table 3. Design Requirements**

PARAMETER	VALUE
High-side supply voltage	5 V
Low-side supply voltage	3 V, or 3.3 V, or 5 V
Voltage drop across shunt for linear response	±250 mV (max)

### 8.2.1.2 Detailed Design Procedure

The high-side power supply (VDD1) for the AMC1200-Q1 is derived from the power supply of the upper gate driver. Further details are provided in the [Power Supply Recommendations](#) section.

The floating ground reference (GND1) is derived from one of the ends of the shunt resistor that is connected to the negative input of the AMC1200-Q1 (VINN). If a four-pin shunt is used, the inputs of the AMC1200-Q1 are connected to the inner leads and GND1 is connected to one of the outer shunt leads.

Use Ohm's Law to calculate the voltage drop across the shunt resistor ( $V_{SHUNT}$ ) for the desired current to be measured:  $V_{SHUNT} = I \times R_{SHUNT}$ .

Consider the following two restrictions to choose the proper value of the shunt resistor  $R_{SHUNT}$ :

- The voltage drop caused by the nominal current range must not exceed the recommended differential input voltage range:  $V_{SHUNT} \leq \pm 250 \text{ mV}$
- The voltage drop caused by the maximum allowed overcurrent must not exceed the input voltage that causes a clipping output:  $V_{SHUNT} \leq V_{Clipping}$

For best performance, use an RC filter (components  $R_2$ ,  $R_3$ , and  $C_2$  in Figure 32) to limit the noise bandwidth of the differential input signal. Limiting the value of resistors  $R_2$  and  $R_3$  to less than  $24 \Omega$  is recommended to avoid incomplete settling of the AMC1200-Q1 input circuitry (see [Analog Input](#)).

Optionally, the common-mode capacitors  $C_3$  and  $C_4$  can be used to reduce charge dumping from the inputs. Mismatch in values of  $C_3$  and  $C_4$  leads to a common-mode error at the modulator input. In this case, choose the value of the differential filter capacitor  $C_2$  to be at least 10 times larger than the values of  $C_3$  and  $C_4$  to limit the effect of the common-mode error. NPO-type capacitors are recommended to be used for  $C_2$ ,  $C_3$  and  $C_4$ .

The differential output of the AMC1200-Q1 can either directly drive an analog-to-digital converter (ADC) input or can be further filtered before being processed by an ADC. For more information on the general procedure to design the filtering and driving stages for SAR ADCs, consult the TI Precision Designs *18 bit, 1Msps Data Acquisition Block Optimized for Lowest Distortion and Noise* (SLAU515), and *18 bit Data Acquisition Block Optimized for Lowest Power* (SLAU513) available for download at [www.ti.com](http://www.ti.com).



### 8.2.1.3 Application Curves

In traction inverter applications, the power switches must be protected in case of an overcurrent condition. To allow fast powering off of the system, a low delay caused by the isolation amplifier is required. Figure 33 shows the typical full-scale step response of the AMC1200-Q1.

The high linearity of the AMC1200-Q1, as shown in Figure 34, allows design of traction inverters with low torque ripple.

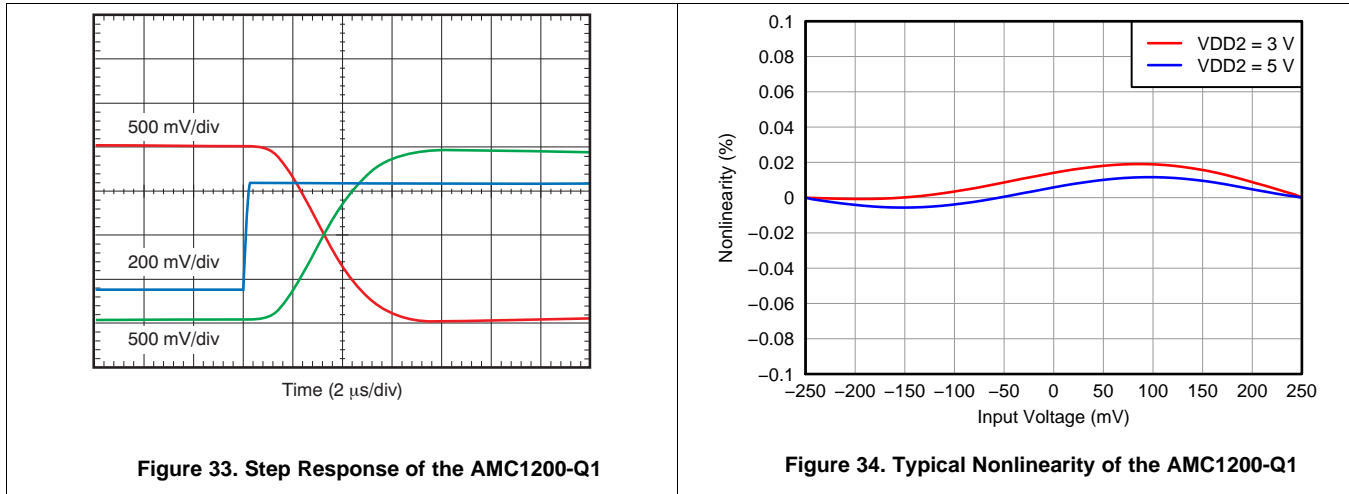

Figure 33. Step Response of the AMC1200-Q1

Figure 34. Typical Nonlinearity of the AMC1200-Q1

### 8.2.2 Isolated Voltage Measurement

The AMC1200-Q1 can also be used for isolated voltage measurement applications, as shown in a simplified way in Figure 35. In such applications, usually a resistor divider (as conceptually indicated by  $R_1$  and  $R_2$ ) is used to scale the voltage amplitude. Choose the value of  $R_2$  to match the maximum voltage to be measured to the differential input voltage range  $V_{IN}$  of the device.  $R_2$  and the input resistance  $R_{IN}$  of the AMC1200-Q1 also create a resistance divider that results in additional gain error. With the assumption that  $R_1$  and  $R_{IN}$  have a considerably higher value than  $R_2$ , the resulting total gain error can be estimated using Equation 1:

$$G_{ERRTOT} = G_{ERR} + \frac{R_2}{R_{IN}}$$

where

- $G_{ERR}$  = the gain error of the AMC1200-Q1 (1)

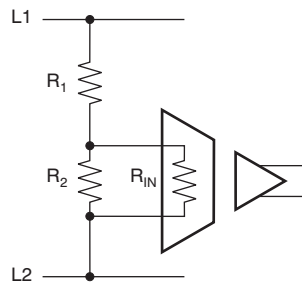
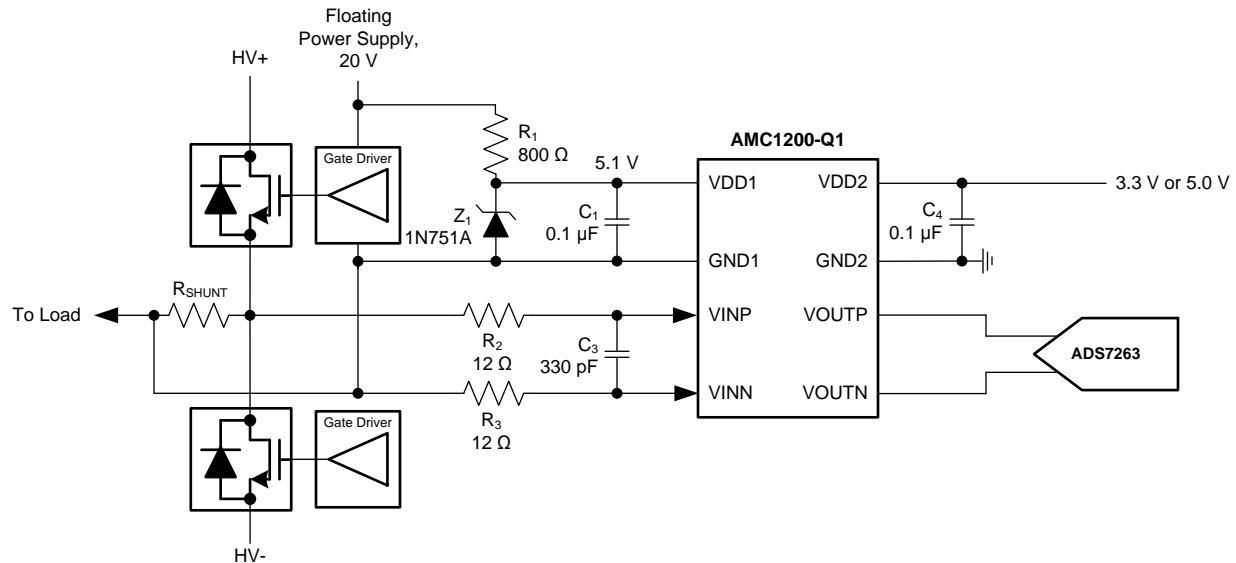

Figure 35. Voltage Measurement Application

## 9 Power Supply Recommendations

In a typical frequency inverter application, the high-side power supply for the AMC1200-Q1 (VDD1) is derived from the system supply, as shown in Figure 36. For lowest cost, a Zener diode can be used to limit the voltage to  $5\text{ V} \pm 10\%$ . Using a  $0.1\text{-}\mu\text{F}$ , low-ESR decoupling capacitor is recommended for filtering VDD1. Using a  $0.1\text{-}\mu\text{F}$  decoupling capacitor is also recommended for filtering the power-supply on the VDD2 side. For best performance, place the decoupling capacitors ( $C_1$  and  $C_4$ ) as close as possible to the VDD1 and VDD2 pins, respectively. If better filtering is required, an additional  $1\text{-}\mu\text{F}$  to  $10\text{-}\mu\text{F}$  capacitor can be used in parallel to  $C_1$  and  $C_4$ .



**Figure 36. Zener Diode Based High-Side Supply**

For higher power efficiency and better performance, a buck converter can be used to generate VDD1; an example of such an approach is based on the LM5017. The PMP9480 reference design (*Isolated Bias Supplies + Isolated Amplifier Combo for Line Voltage or Current Measurement*) with performance test results and layout documentation is available from [www.ti.com](http://www.ti.com).

The AMC1200-Q1 does not require any particular power sequence and is operational when both power supplies, VDD1 and VDD2, are applied.

## 10 Layout

### 10.1 Layout Guidelines

A layout recommendation showing the critical placement of the decoupling capacitors placed as close as possible to the AMC1200-Q1 and maintaining a differential routing of the input signals is shown in [Figure 37](#).

To maintain the isolation barrier and the high CMTI of the device, the distance between the high-side ground (GND1) and the low-side ground (GND2) must be kept at maximum; that is, the entire area underneath the device must be kept free of any conducting materials.

### 10.2 Layout Example

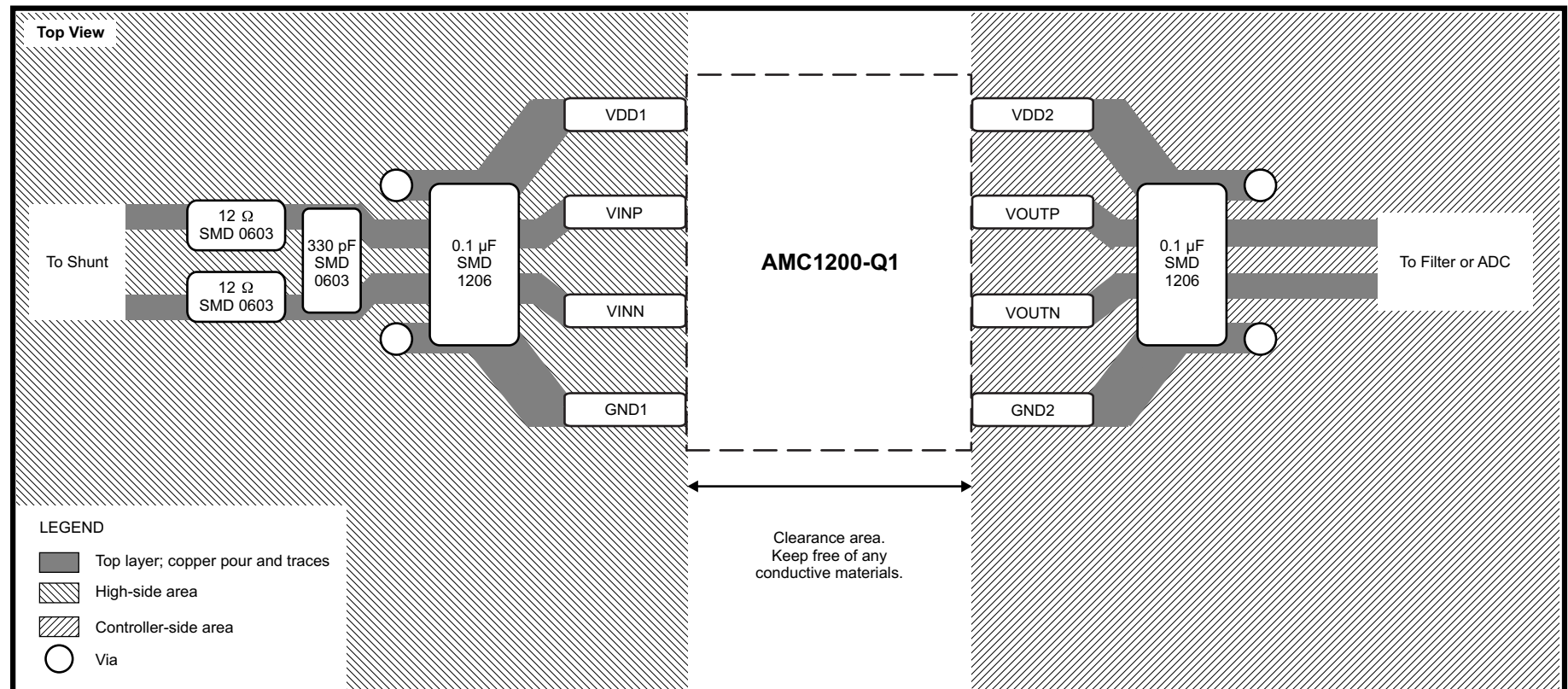

Figure 37. Layout Recommendation

## 11 Device and Documentation Support

### 11.1 Documentation Support

#### 11.1.1 Related Documentation

For related documentation see the following:

- LM5017 Data Sheet, [SNVS783](#)
- ADS7263 Data Sheet, [SBAS523](#)
- *TI Isolation Glossary*, [SLLA353](#)
- *18 bit, 1Msps Data Acquisition Block Optimized for Lowest Distortion and Noise*, [SLAU515](#)
- *18 bit Data Acquisition Block Optimized for Lowest Power*, [SLAU513](#)
- *High-Voltage Lifetime of the ISO72x Family of Digital Isolators*, [SLLA197](#)
- *ISO72x Digital Isolator Magnetic-Field Immunity*, [SLLA181](#)
- *AMC1100: Replacement of Input Main Sensing Transformer in Inverters with Isolate Amplifier*, [SLAA552](#)
- *Isolated Current Sensing Reference Design Solution, 5A, 2kV*, [TIPD121](#)
- *Isolated Bias Supplies + Isolated Amplifier Combo for Line Voltage or Current Measurement*, [PMP9480](#)
- LM5017 Data Sheet, [SNVS783](#)

### 11.2 Community Resources

The following links connect to TI community resources. Linked contents are provided "AS IS" by the respective contributors. They do not constitute TI specifications and do not necessarily reflect TI's views; see TI's [Terms of Use](#).

**TI E2E™ Online Community** *TI's Engineer-to-Engineer (E2E) Community*. Created to foster collaboration among engineers. At [e2e.ti.com](http://e2e.ti.com), you can ask questions, share knowledge, explore ideas and help solve problems with fellow engineers.

**Design Support** *TI's Design Support* Quickly find helpful E2E forums along with design support tools and contact information for technical support.

### 11.3 Trademarks

E2E is a trademark of Texas Instruments.

All other trademarks are the property of their respective owners.

### 11.4 Electrostatic Discharge Caution



This integrated circuit can be damaged by ESD. Texas Instruments recommends that all integrated circuits be handled with appropriate precautions. Failure to observe proper handling and installation procedures can cause damage.

ESD damage can range from subtle performance degradation to complete device failure. Precision integrated circuits may be more susceptible to damage because very small parametric changes could cause the device not to meet its published specifications.

### 11.5 Glossary



[SLYZ022](#) — *TI Glossary*.

This glossary lists and explains terms, acronyms, and definitions.

## 12 Mechanical, Packaging, and Orderable Information

The following pages include mechanical, packaging, and orderable information. This information is the most current data available for the designated devices. This data is subject to change without notice and revision of this document. For browser-based versions of this data sheet, refer to the left-hand navigation.

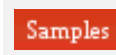
**PACKAGING INFORMATION**

Orderable Device	Status (1)	Package Type	Package Drawing	Pins	Package Qty	Eco Plan (2)	Lead/Ball Finish (6)	MSL Peak Temp (3)	Op Temp (°C)	Device Marking (4/5)	Samples
AMC1200STDUBRQ1	ACTIVE	SOP	DUB	8	350	Green (RoHS & no Sb/Br)	NIPDAU	Level-3-260C-168 HR	-40 to 105	1200Q	
AMC1200TDWVRQ1	ACTIVE	SOIC	DWV	8	1000	Green (RoHS & no Sb/Br)	NIPDAU	Level-2-260C-1 YEAR	-40 to 105	1200Q	

(1) The marketing status values are defined as follows:

**ACTIVE:** Product device recommended for new designs.

**LIFEBUY:** TI has announced that the device will be discontinued, and a lifetime-buy period is in effect.

**NRND:** Not recommended for new designs. Device is in production to support existing customers, but TI does not recommend using this part in a new design.

**PREVIEW:** Device has been announced but is not in production. Samples may or may not be available.

**OBsolete:** TI has discontinued the production of the device.

(2) **RoHS:** TI defines "RoHS" to mean semiconductor products that are compliant with the current EU RoHS requirements for all 10 RoHS substances, including the requirement that RoHS substance do not exceed 0.1% by weight in homogeneous materials. Where designed to be soldered at high temperatures, "RoHS" products are suitable for use in specified lead-free processes. TI may reference these types of products as "Pb-Free".

**RoHS Exempt:** TI defines "RoHS Exempt" to mean products that contain lead but are compliant with EU RoHS pursuant to a specific EU RoHS exemption.

**Green:** TI defines "Green" to mean the content of Chlorine (Cl) and Bromine (Br) based flame retardants meet JS709B low halogen requirements of <=1000ppm threshold. Antimony trioxide based flame retardants must also meet the <=1000ppm threshold requirement.

(3) MSL, Peak Temp. - The Moisture Sensitivity Level rating according to the JEDEC industry standard classifications, and peak solder temperature.

(4) There may be additional marking, which relates to the logo, the lot trace code information, or the environmental category on the device.

(5) Multiple Device Markings will be inside parentheses. Only one Device Marking contained in parentheses and separated by a "~" will appear on a device. If a line is indented then it is a continuation of the previous line and the two combined represent the entire Device Marking for that device.

(6) Lead/Ball Finish - Orderable Devices may have multiple material finish options. Finish options are separated by a vertical ruled line. Lead/Ball Finish values may wrap to two lines if the finish value exceeds the maximum column width.

**Important Information and Disclaimer:**The information provided on this page represents TI's knowledge and belief as of the date that it is provided. TI bases its knowledge and belief on information provided by third parties, and makes no representation or warranty as to the accuracy of such information. Efforts are underway to better integrate information from third parties. TI has taken and continues to take reasonable steps to provide representative and accurate information but may not have conducted destructive testing or chemical analysis on incoming materials and chemicals. TI and TI suppliers consider certain information to be proprietary, and thus CAS numbers and other limited information may not be available for release.

In no event shall TI's liability arising out of such information exceed the total purchase price of the TI part(s) at issue in this document sold by TI to Customer on an annual basis.

**OTHER QUALIFIED VERSIONS OF AMC1200-Q1 :**

- Catalog: [AMC1200](#)

## NOTE: Qualified Version Definitions:

- Catalog - TI's standard catalog product

## TAPE AND REEL INFORMATION



### QUADRANT ASSIGNMENTS FOR PIN 1 ORIENTATION IN TAPE



\*All dimensions are nominal

Device	Package Type	Package Drawing	Pins	SPQ	Reel Diameter (mm)	Reel Width W1 (mm)	A0 (mm)	B0 (mm)	K0 (mm)	P1 (mm)	W (mm)	Pin1 Quadrant
AMC1200STDUBRQ1	SOP	DUB	8	350	330.0	24.4	10.9	10.01	5.85	16.0	24.0	Q1
AMC1200TDWVRQ1	SOIC	DWV	8	1000	330.0	16.4	12.05	6.15	3.3	16.0	16.0	Q1

**TAPE AND REEL BOX DIMENSIONS**

\*All dimensions are nominal

Device	Package Type	Package Drawing	Pins	SPQ	Length (mm)	Width (mm)	Height (mm)
AMC1200STDUBRQ1	SOP	DUB	8	350	346.0	346.0	29.0
AMC1200TDWVRQ1	SOIC	DWV	8	1000	350.0	350.0	43.0



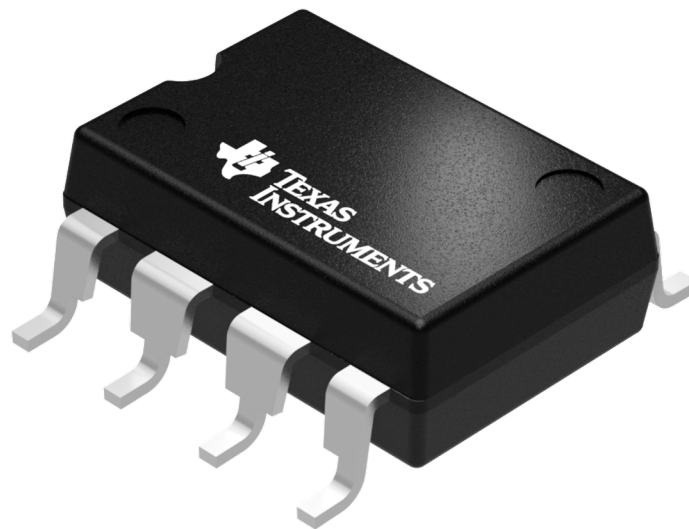

Images above are just a representation of the package family, actual package may vary.  
Refer to the product data sheet for package details.

# DUB0008A



# PACKAGE OUTLINE

SOP - 4.85 mm max height

SMALL OUTLINE PACKAGE

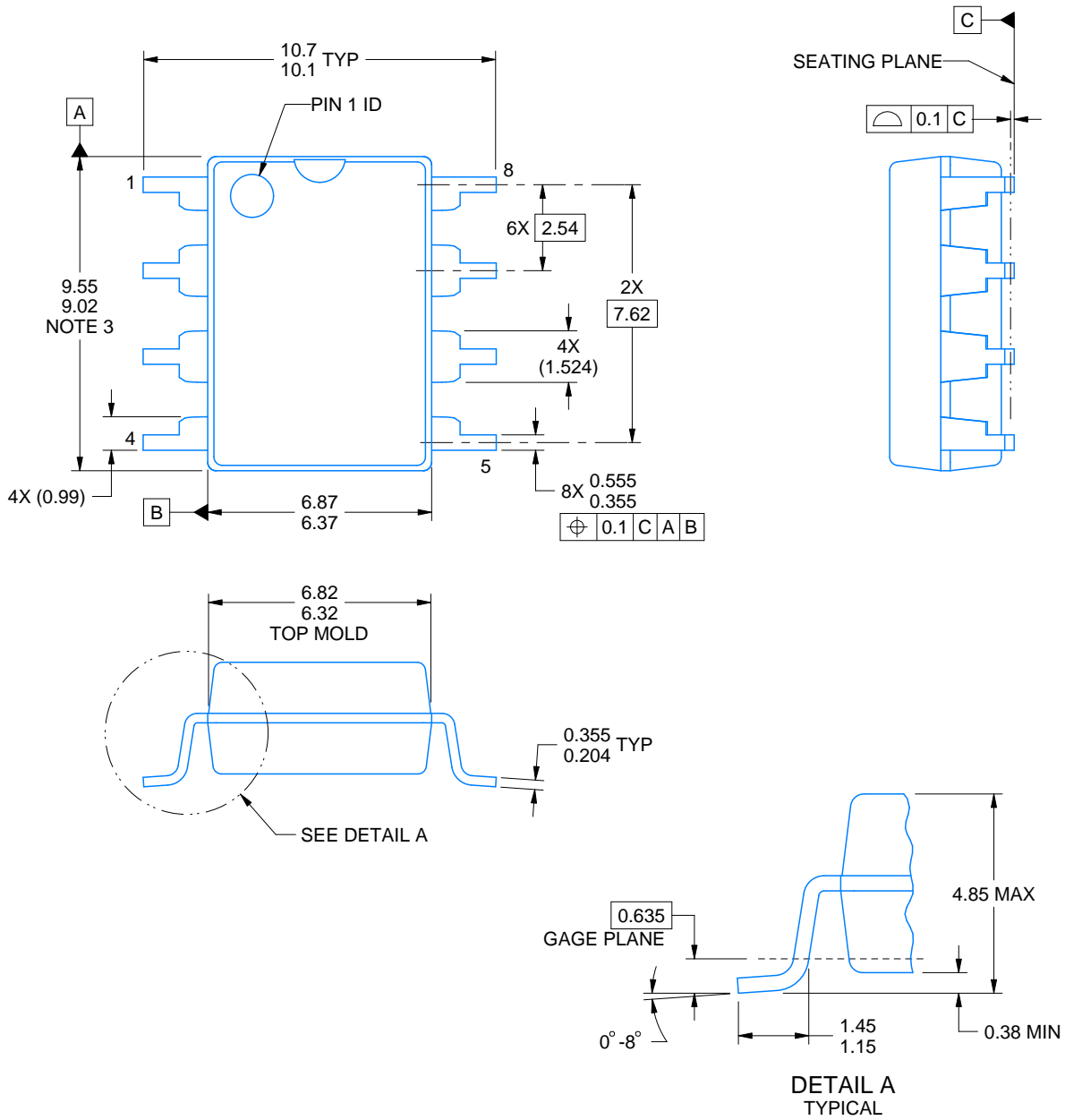

4222355/G 04/2019

## NOTES:

1. All linear dimensions are in millimeters. Any dimensions in parenthesis are for reference only. Dimensioning and tolerancing per ASME Y14.5M.
2. This drawing is subject to change without notice.
3. This dimension does not include mold flash, protrusions, or gate burrs. Mold flash, protrusions, or gate burrs shall not exceed 0.254 mm per side.

# EXAMPLE BOARD LAYOUT

DUB0008A

SOP - 4.85 mm max height

SMALL OUTLINE PACKAGE

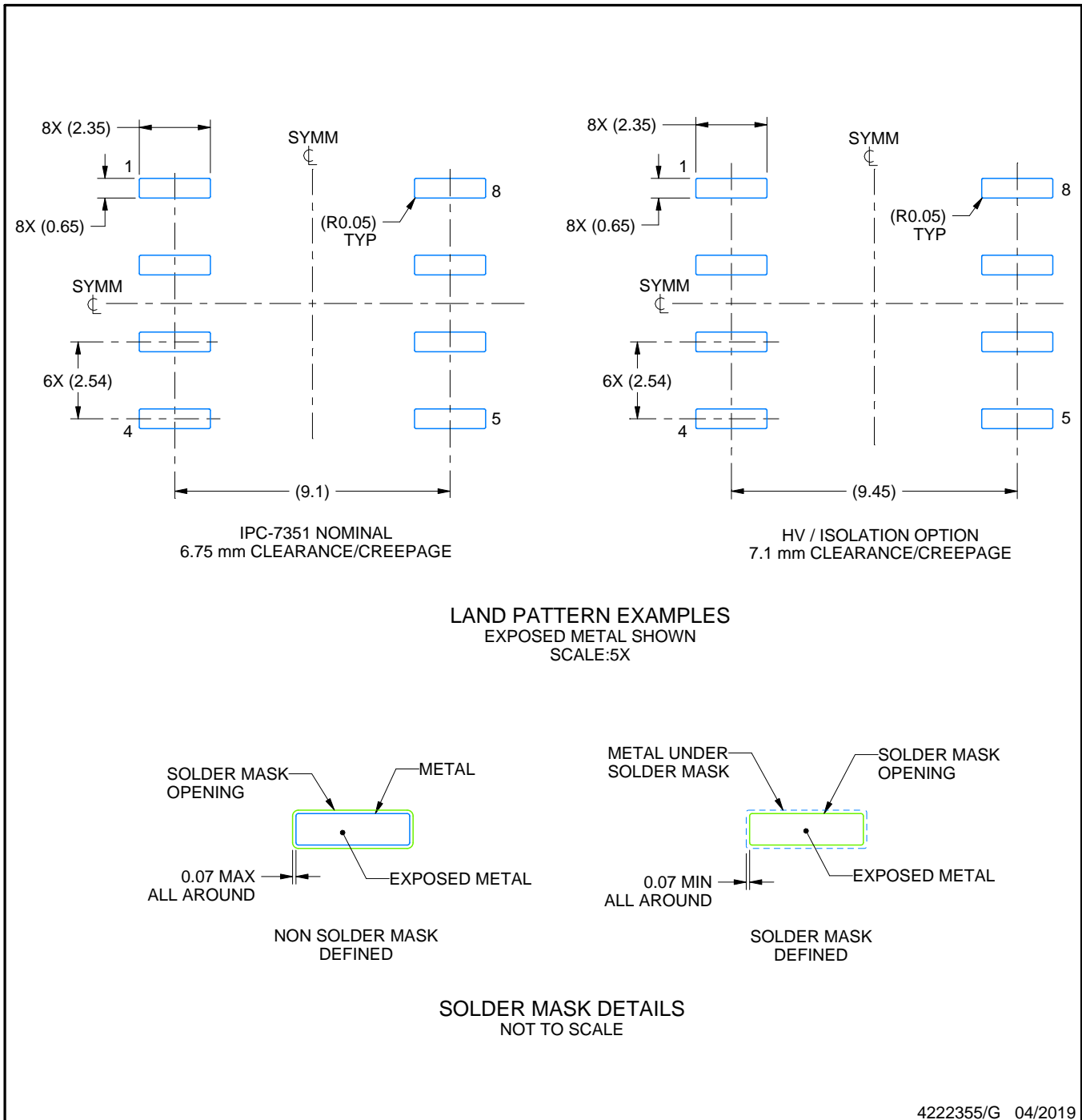

NOTES: (continued)

4. Publication IPC-7351 may have alternate designs.
5. Solder mask tolerances between and around signal pads can vary based on board fabrication site.

# EXAMPLE STENCIL DESIGN

DUB0008A

SOP - 4.85 mm max height

SMALL OUTLINE PACKAGE

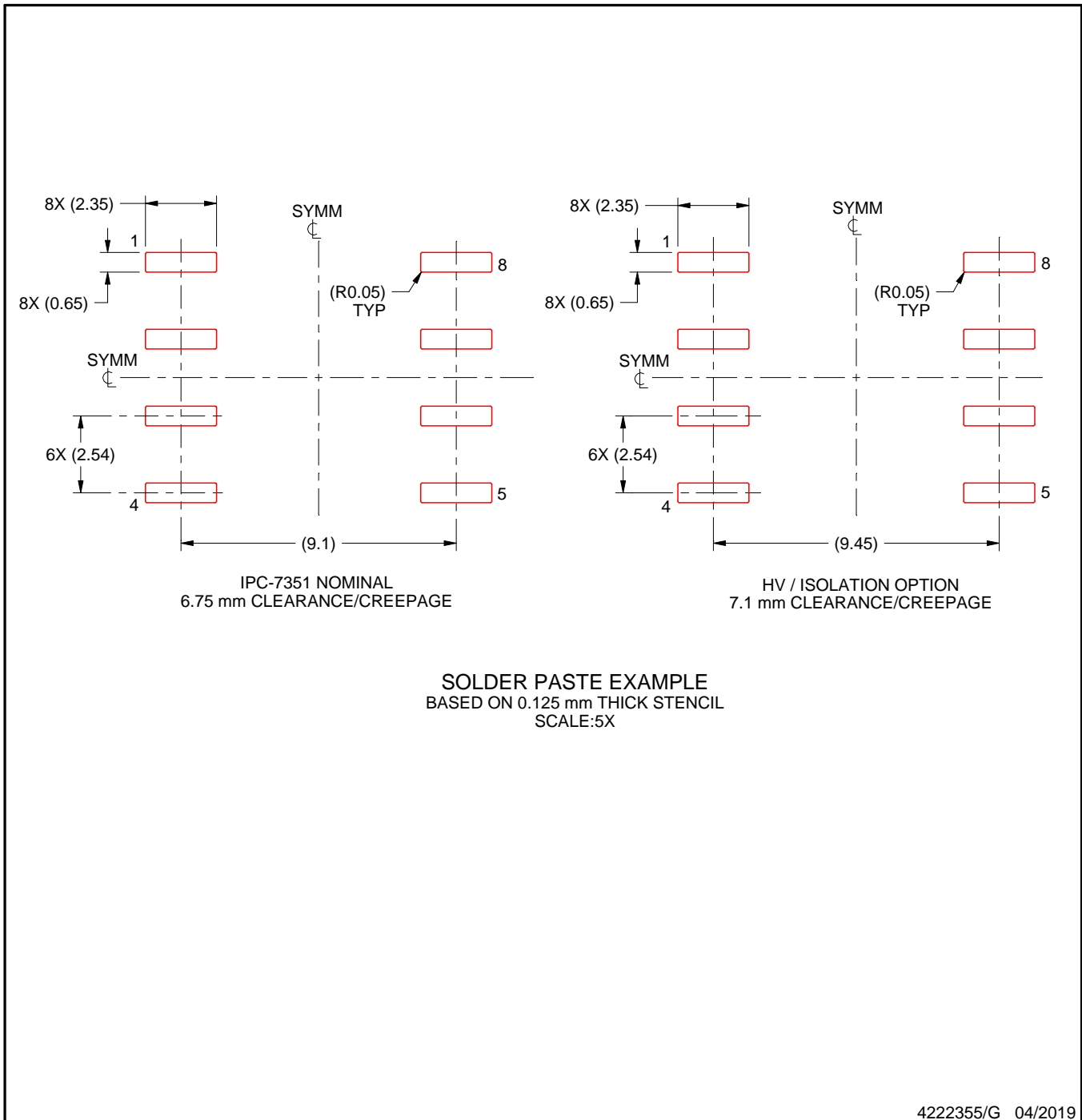

NOTES: (continued)

6. Laser cutting apertures with trapezoidal walls and rounded corners may offer better paste release. IPC-7525 may have alternate design recommendations.
7. Board assembly site may have different recommendations for stencil design.

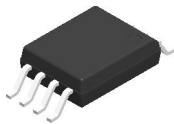

DWV0008A

SOIC - 2.8 mm max height

SOIC

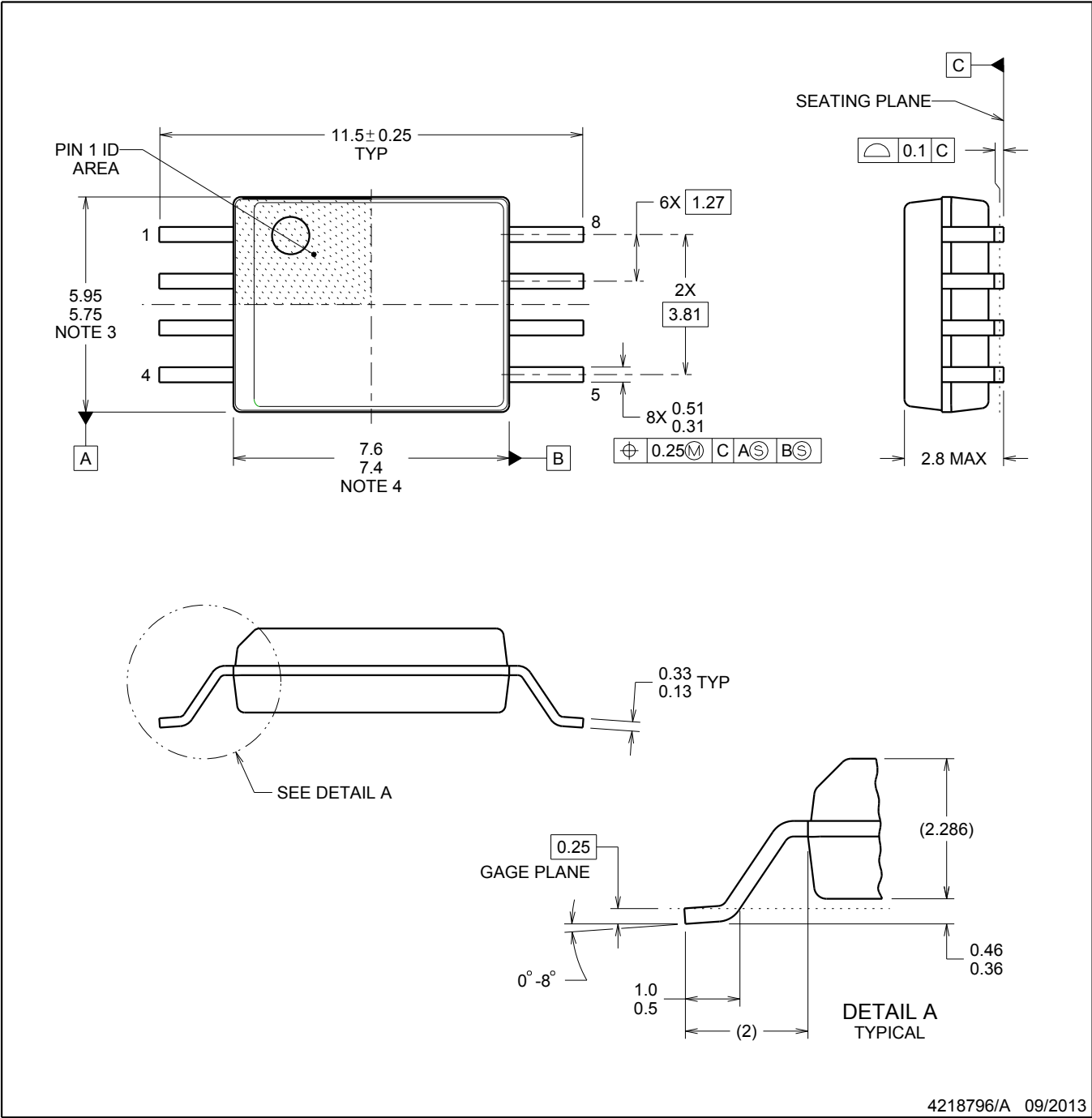

4218796/A 09/2013

NOTES:

- 1. All linear dimensions are in millimeters. Dimensions in parenthesis are for reference only. Dimensioning and tolerancing per ASME Y14.5M.
- 2. This drawing is subject to change without notice.
- 3. This dimension does not include mold flash, protrusions, or gate burrs. Mold flash, protrusions, or gate burrs shall not exceed 0.15 mm, per side.
- 4. This dimension does not include interlead flash. Interlead flash shall not exceed 0.25 mm, per side.



LAND PATTERN EXAMPLE  
9.1 mm NOMINAL CLEARANCE/CREEPAGE  
SCALE:6X

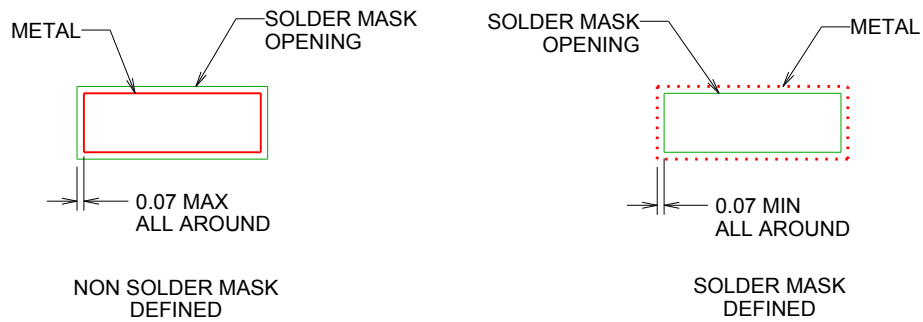

SOLDER MASK DETAILS

4218796/A 09/2013

NOTES: (continued)

- 5. Publication IPC-7351 may have alternate designs.
- 6. Solder mask tolerances between and around signal pads can vary based on board fabrication site.

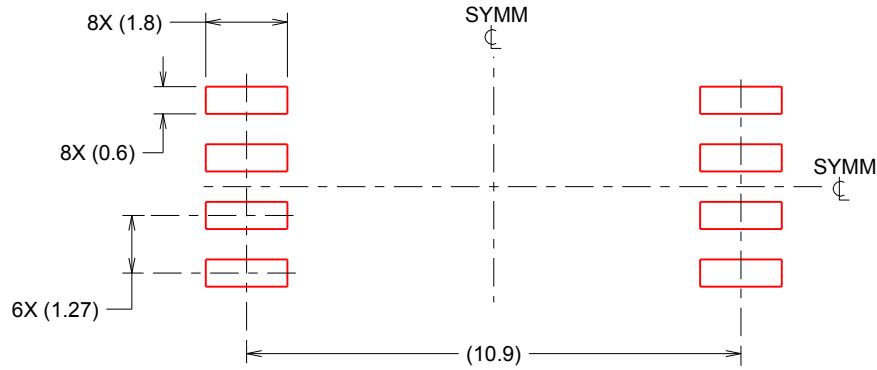

SOLDER PASTE EXAMPLE  
 BASED ON 0.125 mm THICK STENCIL  
 SCALE:6X

4218796/A 09/2013

NOTES: (continued)

- 7. Laser cutting apertures with trapezoidal walls and rounded corners may offer better paste release. IPC-7525 may have alternate design recommendations.
- 8. Board assembly site may have different recommendations for stencil design.

## IMPORTANT NOTICE AND DISCLAIMER

TI PROVIDES TECHNICAL AND RELIABILITY DATA (INCLUDING DATASHEETS), DESIGN RESOURCES (INCLUDING REFERENCE DESIGNS), APPLICATION OR OTHER DESIGN ADVICE, WEB TOOLS, SAFETY INFORMATION, AND OTHER RESOURCES "AS IS" AND WITH ALL FAULTS, AND DISCLAIMS ALL WARRANTIES, EXPRESS AND IMPLIED, INCLUDING WITHOUT LIMITATION ANY IMPLIED WARRANTIES OF MERCHANTABILITY, FITNESS FOR A PARTICULAR PURPOSE OR NON-INFRINGEMENT OF THIRD PARTY INTELLECTUAL PROPERTY RIGHTS.

These resources are intended for skilled developers designing with TI products. You are solely responsible for (1) selecting the appropriate TI products for your application, (2) designing, validating and testing your application, and (3) ensuring your application meets applicable standards, and any other safety, security, or other requirements. These resources are subject to change without notice. TI grants you permission to use these resources only for development of an application that uses the TI products described in the resource. Other reproduction and display of these resources is prohibited. No license is granted to any other TI intellectual property right or to any third party intellectual property right. TI disclaims responsibility for, and you will fully indemnify TI and its representatives against, any claims, damages, costs, losses, and liabilities arising out of your use of these resources.

TI's products are provided subject to TI's Terms of Sale ([www.ti.com/legal/termsofsale.html](http://www.ti.com/legal/termsofsale.html)) or other applicable terms available either on [ti.com](http://ti.com) or provided in conjunction with such TI products. TI's provision of these resources does not expand or otherwise alter TI's applicable warranties or warranty disclaimers for TI products.

Mailing Address: Texas Instruments, Post Office Box 655303, Dallas, Texas 75265  
Copyright © 2020, Texas Instruments Incorporated