

1

2

3

4

5

TECHNICAL CHARACTERISTICS

MATERIAL
 INSULATOR: NYLON 66
 FLAMABILITY RATING: UL94-V0
 COLOR: BEIGE
 PITCH: 2.54 MM

ENVIRONMENTAL
 OPERATING TEMPERATURE: -40 UP TO 105°C
 COMPLIANCE: LEAD FREE AND ROHS

ELECTRICAL
 INSULATOR RESISTANCE: >1000 MOHM
 DIELECTRIC WITHSTANDING VOLTAGE: 1000 VAC/MN

STANDARD
 CERTIFIED: E323964

PACKAGING
 BAG

DIMENSION

PINS	A
2	5.60
3	8.10
4	10.70
5	13.20
6	15.80
8	20.90
10	25.90
12	31.00
14	36.10

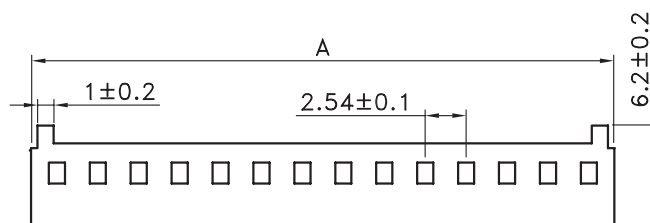
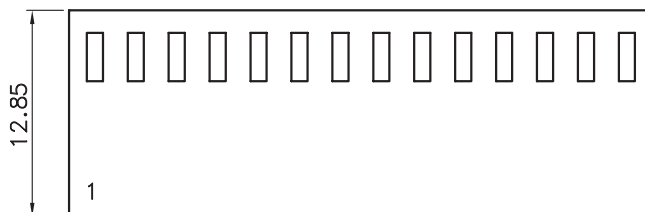
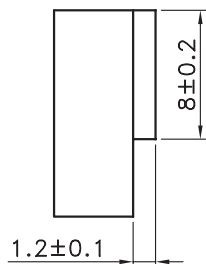
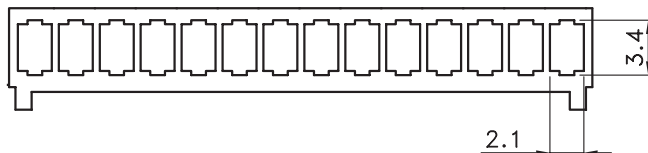

RoHS Compliant

PROJECTION:



GENERAL TOLERANCE

.X = ± 0.2 .XX = ± 0.15 

WÜRTH ELEKTRONIK

APPROVAL: BBu

UNIT: MM

SCALE:

SHEET: 1/3

DRAW: PEARL

DESCRIPTION: 2.54 MM FEMALE TERMINAL HOUSING

WERI PART NO: 619 0xx 116 21

SIZE

A4

REV	DATE	FILE	BY
J	29-SEP-17	TPK	AK
I	12-SEP-16	DRAWING	AK
H	19-JAN-16	TPK	AK

A

B

C

D

1

2

3

4

5



PE BAG

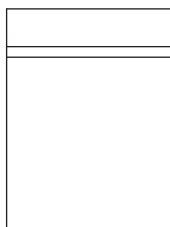

Note:

1.Dimension:

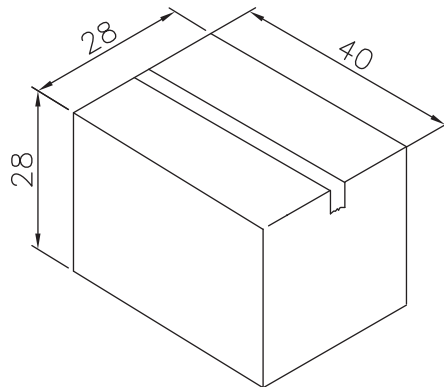
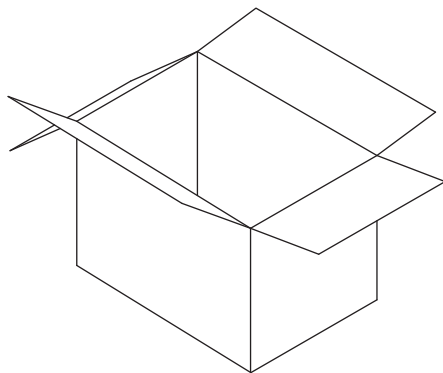

Carton Size:40*28*28(cm)

Pin.	Pcs/Bag	Pcs/Carton	Pin.	Pcs/Bag	Pcs/Carton
2	1000	38000	7	1000	12000
3	1000	24000	8	1000	10000
4	1000	20000	9	1000	10000
5	1000	16000	10	1000	7000
6	1000	12000	12	1000	5000

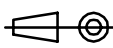

Carton

RoHS Compliant

G				PROJECTION: 	GENERAL TOLERANCE .X = +/- 0.2 .XX = +/- 0.15		
F							
E							
D							
C				APPROVAL: BBu	UNIT: MM	DESCRIPTION: 2.54 MM FEMALE TERMINAL HOUSING	
B					SCALE:		
A					SHEET: 2/3	WERI PART NO: 619 0xx 116 21	SIZE A4
REV	DATE	FILE	BY		DRAW: PEARL		

Mouser Electronics

Authorized Distributor

Click to View Pricing, Inventory, Delivery & Lifecycle Information:

[Wurth Electronics:](#)

[61900511621](#) [61900411621](#) [61900211621](#) [61900311621](#)