

THIS DOCUMENT IS THE PROPERTY OF
KEYSTONE ELECTRONICS CORP. AND
SHALL NOT BE REPRODUCED, DISTRIBUTED
OR USED AS A BASIS FOR MANUFACTURE
WITHOUT PRIOR WRITTEN PERMISSION
FROM KEYSTONE ELECTRONICS CORP.

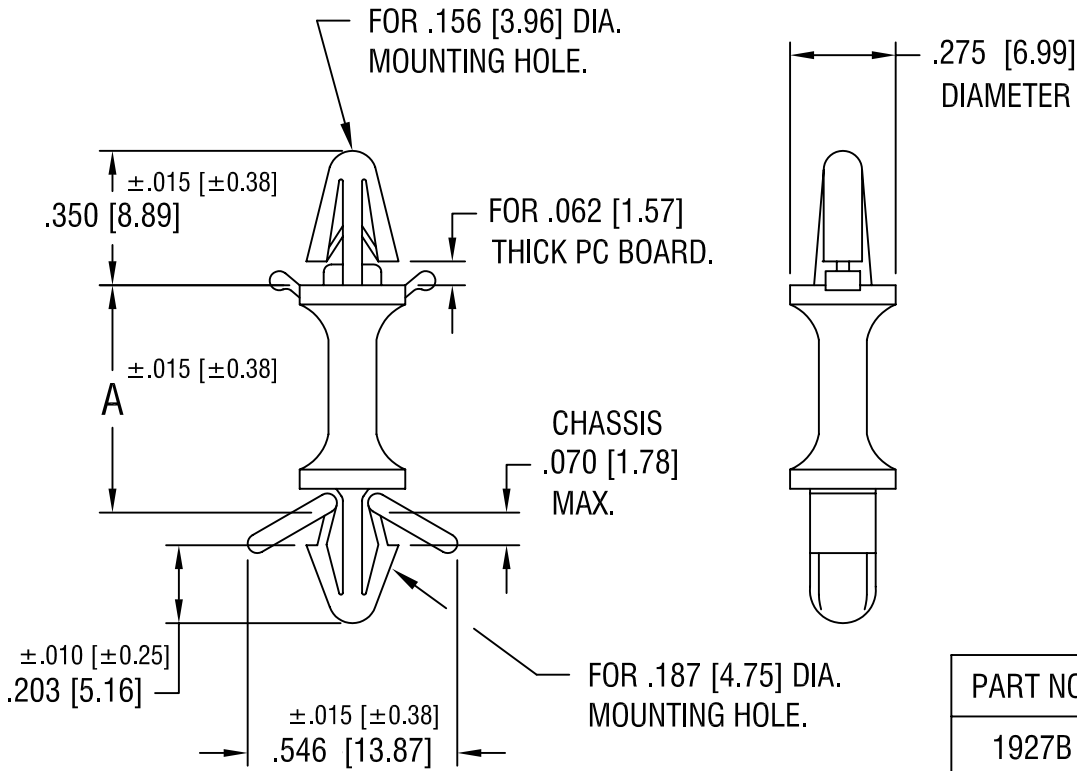

PART NO.	'A' DIM.
1927B	.250 [6.35]
1928B	.375 [9.52]
1929B	.500 [12.70]
1930B	.625 [15.87]
1931B	.750 [19.05]
1932B	.875 [22.22]
1933B	1.000 [25.40]

KEYSTONE ELECTRONICS CORP.

ASTORIA, N.Y. 11105-2017

PART NAME

PC LOCK-IN SUPPORT

MATERIAL

NYLON UL 94V-0

FINISH

-

DRN BY

BOONE

DATE

11.20.95

APPD

LN

SCALE

2X

TOLERANCES

INCH [MM]

DECIMAL ±.005 [±0.15]

ANGULAR ± 1°

UNLESS OTHERWISE SPECIFIED

CODE

C

DWG NO.

1927B-1933B

DATE

DESCRIPTION

REV.

Mouser Electronics

Authorized Distributor

Click to View Pricing, Inventory, Delivery & Lifecycle Information:

[Keystone Electronics:](#)

[1929B](#)