

## DB101S-G Thru. DB107S-G

Reverse Voltage: 50 to 1000V

Forward Current: 1.0A

RoHS Device

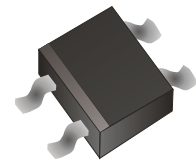

### Features

- Rating to 1000V PRV.
- Ideal for printed circuit board.
- Low forward voltage drop.
- High current capability.
- The plastic material has UL flammability classification 94V-0
- UL recognized file # E349301

### Mechanical Data

- Polarity: As marked on Body.
- Weight: 0.38 grams.
- Mounting position: Any.

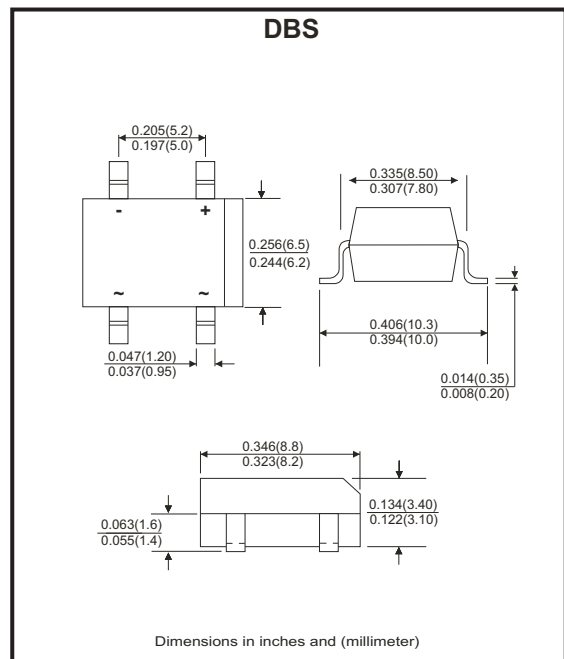

### Maximum ratings and electrical characteristics

Rating at 25°C ambient temperature unless otherwise specified.  
 Single phase, half wave, 60Hz, resistive or inductive load.  
 For capacitive load, derate current by 20%

Parameter	Symbol	DB 101S-G	DB 102S-G	DB 103S-G	DB 104S-G	DB 105S-G	DB 106S-G	DB 107S-G	Unit
Maximum Recurrent Peak Reverse Voltage	$V_{RRM}$	50	100	200	400	600	800	1000	V
Maximum RMS Voltage	$V_{RMS}$	35	70	140	280	420	560	700	V
Maximum DC Blocking Voltage	$V_{DC}$	50	100	200	400	600	800	1000	V
Maximum Average Forward Rectified Current @ $T_A=40^\circ C$	$I_{(AV)}$	1.0							A
Peak Forward Surge Current, 8.3ms Single Half Sine-Wave Super Imposed On Rated Load (JEDEC Method)	$I_{FSM}$	30							A
Maximum Forward Voltage at 1.0A DC	$V_F$	1.1							V
Maximum DC Reverse Current At Rated DC Blocking Voltage @ $T_J=25^\circ C$ @ $T_J=125^\circ C$	$I_R$	10.0 500							$\mu A$
$I^2 T$ Rating for Fusing ( $t < 8.3ms$ )	$I^2 t$	3.735							$A^2 s$
Typical Junction Capacitance Per Element (Note 1)	$C_J$	25							pF
Typical Thermal Resistance (Note 2)	$R_{\theta JA}$	40							$^\circ C/W$
Operating Temperature Range	$T_J$	-55 to +150							$^\circ C$
Storage Temperature Range	$T_{STG}$	-55 to +150							$^\circ C$

Notes:

1. Measured at 1.0MHz and applied reverse voltage of 4.0V DC.
2. Thermal resistance from junction to ambient mounted on P.C.B with 0.5"×0.5" (13×13mm) copper pads.

Company reserves the right to improve product design , functions and reliability without notice.

REV: F

## Rating and Characteristics Curves (DB101S-G Thru. DB107S-G)

Fig.1 - Forward Current Derating Curve

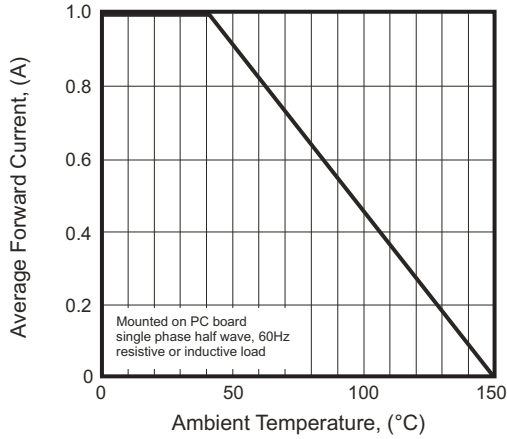

Fig.2 - Max. Non-repetitive Surge Current

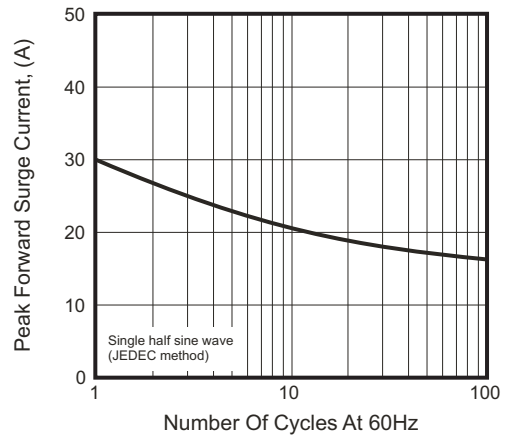

Fig.3 - Typical Junction Capacitance

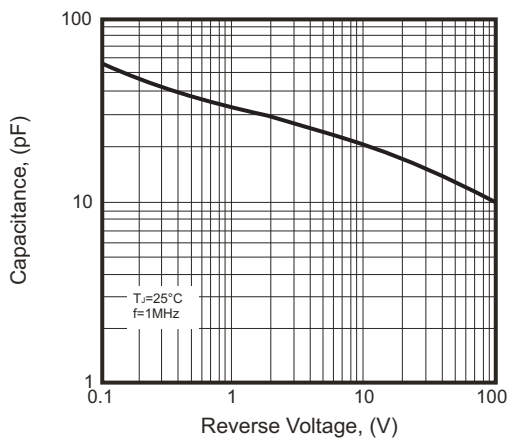

Fig.4 - Typical Forward Characteristics

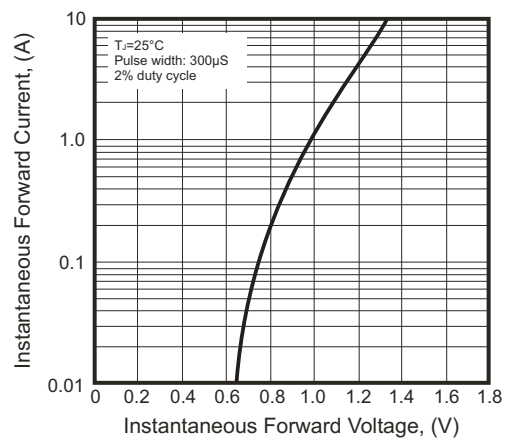
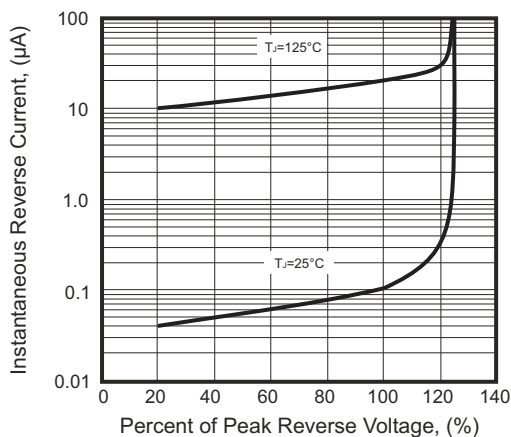
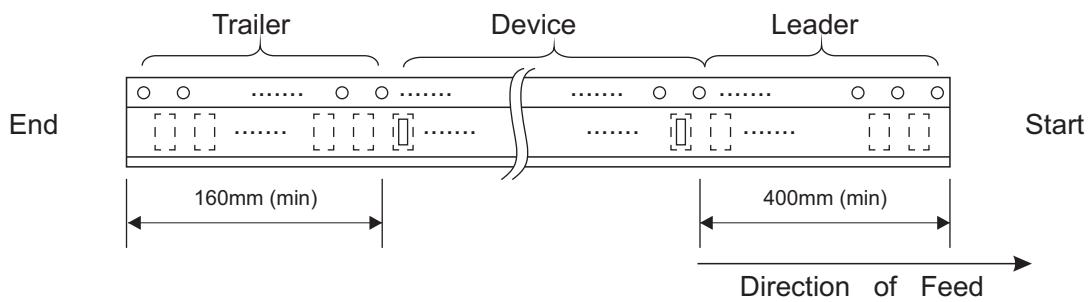
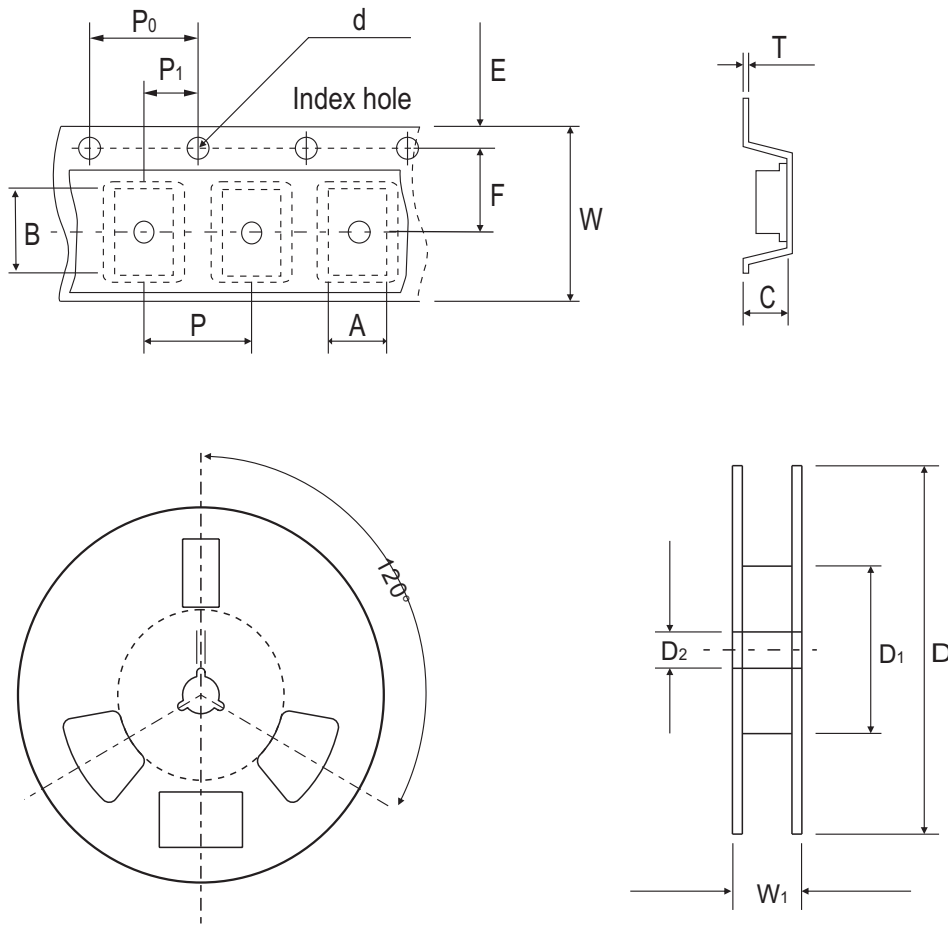

Fig.5 - Typical Reverse Characteristics



Company reserves the right to improve product design, functions and reliability without notice.

## Reel Taping Specification



DBS	SYMBOL	A	B	C	d	D	D1	D2
	(mm)	8.64 ± 0.10	10.41 ± 0.10	3.81 ± 0.10	1.55 ± 0.05	330	50.0 MIN.	13.00 ± 0.20
	(inch)	0.340 ± 0.004	0.409 ± 0.004	0.150 ± 0.004	0.061 ± 0.002	13	1.969 MIN.	0.512 ± 0.008

DBS	SYMBOL	E	F	P	P0	P1	T	W	W1
	(mm)	1.75 ± 0.10	7.50 ± 0.05	12.00 ± 0.10	4.00 ± 0.10	2.00 ± 0.10	0.32	16.00 ± 0.30	16.00~18.40
	(inch)	0.069 ± 0.004	0.295 ± 0.002	0.472 ± 0.004	0.157 ± 0.004	0.079 ± 0.004	0.013	0.630 ± 0.012	0.630~0.724

Company reserves the right to improve product design, functions and reliability without notice.

## Marking Code

Part Number	Marking code	Packaging
DB101SP-G	DB101S	Tube
DB102SP-G	DB102S	Tube
DB103SP-G	DB103S	Tube
DB104SP-G	DB104S	Tube
DB105SP-G	DB105S	Tube
DB106SP-G	DB106S	Tube
DB107SP-G	DB107S	Tube
DB101ST-G	DB101S	Reel
DB102ST-G	DB102S	Reel
DB103ST-G	DB103S	Reel
DB104ST-G	DB104S	Reel
DB105ST-G	DB105S	Reel
DB106ST-G	DB106S	Reel
DB107ST-G	DB107S	Reel

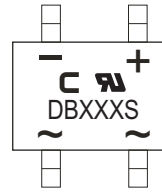

**XXX = Product type marking code**  
**C = Comchip Logo**

Note:

1) Suffix code after part number to specify packaging item .

Packaging	Code
TUBE PACK	P
REEL PACK	T

## Suggested PAD Layout

SIZE	DBS	
	(mm)	(inch)
A	1.20 Min	0.047 Min
B	1.52 Min	0.060 Min
C	5.21 Ref	0.205 Ref
D	10.26 Max	0.404 Max

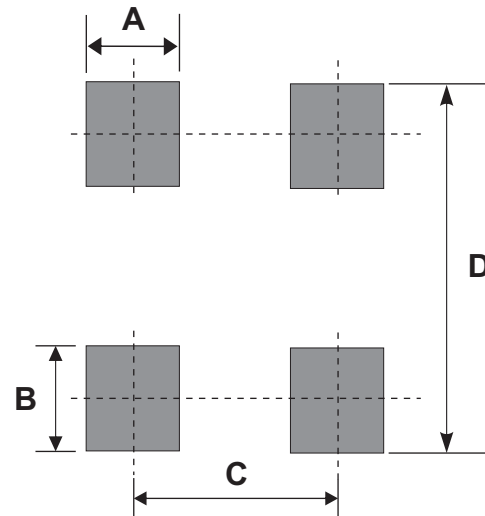

## Standard Packaging

Case Type	TUBE PACK	
	TUBE ( pcs )	BOX ( pcs )
DBS	50	5,000

Case Type	REEL PACK	
	REEL ( pcs )	Reel Size (inch)
DBS	1,000	13

Company reserves the right to improve product design , functions and reliability without notice.

# Mouser Electronics

Authorized Distributor

Click to View Pricing, Inventory, Delivery & Lifecycle Information:

[Comchip Technology:](#)

[DB107S-G](#)