

## Commercial "L", SnPb Termination, X7R Dielectric 6.3 – 250 VDC (Commercial Grade)

### Overview

The KEMET Commercial "L" surface mount capacitors with tin and lead termination in X7R dielectric are designed to meet the needs of critical applications, where tin and lead end metallization is required. KEMET's tin and lead electroplating process is designed to meet a 5% minimum lead content, as well as address concerns for a more robust and reliable lead containing termination system. As the bulk of the electronics industry moves towards RoHS compliance, KEMET continues to provide tin and lead terminated products for the military, aerospace and industrial applications, and will ensure customers have a stable and long-term source of supply.

The KEMET X7R dielectric features a 125°C maximum operating temperature and is considered temperature stable. The Electronics Industries Alliance (EIA) characterizes X7R dielectric as a Class II material. Components of this classification are fixed, ceramic dielectric capacitors suited for bypass and decoupling applications or for frequency discriminating circuits, where Q and stability of capacitance characteristics are not critical. X7R exhibits a predictable change in capacitance with respect to time and voltage, boasting a minimal change in capacitance with reference to ambient temperature. Capacitance change is limited to  $\pm 15\%$  from  $-55^{\circ}\text{C}$  to  $+125^{\circ}\text{C}$ .

### Benefits

- $-55^{\circ}\text{C}$  to  $+125^{\circ}\text{C}$  operating temperature range
- Temperature stable dielectric
- Reliable and robust termination system
- EIA 0402, 0603, 0805, 1206, 1210, 1808, 1812, 1825, 2220 and 2225 case sizes
- DC voltage ratings of 6.3 V, 10 V, 16 V, 25 V, 50 V, 100 V, 200 V and 250 V
- Capacitance offerings ranging from 10 pF to 22  $\mu\text{F}$
- Available capacitance tolerances of  $\pm 5\%$ ,  $\pm 10\%$  and  $\pm 20\%$
- Non-polar device, minimizing installation concerns
- SnPb plated termination finish (5% Pb minimum)
- Flexible termination option available upon request
- Available for other surface mount products, additional dielectrics and higher voltage ratings upon request

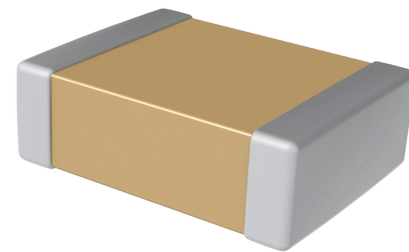

### Applications

Typical applications include military, aerospace and other high reliability applications.

## Ordering Information

| C       | 1210   | C                     | 226  | K                               | 8  | R          | A                    | L                               | TU  |
|---------|--|-----------------------|--|---------------------------------|--|------------|----------------------|---------------------------------|---|
| Ceramic | Case Size (L" x W")  | Specification/ Series | Capacitance Code (pF)                      | Capacitance Tolerance           | Rated Voltage (VDC)  | Dielectric | Failure Rate/ Design | Termination Finish <sup>1</sup> | Packaging/Grade (C-Spec)                      |
|         | 0402<br>0603<br>0805<br>1206<br>1210<br>1808<br>1812<br>1825<br>2220<br>2225 | C = Standard          | Two Significant Digits and Number of Zeros | J = ±5%<br>K = ±10%<br>M = ±20% | 9 = 6.3<br>8 = 10<br>4 = 16<br>3 = 25<br>6 = 35<br>5 = 50<br>1 = 100<br>2 = 200<br>A = 250 | R = X7R    | A = N/A              | L = SnPb (5% Pb minimum)        | See "Packaging C-Spec Ordering Options Table" |

<sup>1</sup> Additional termination finish options may be available. Contact KEMET for details.

## Packaging C-Spec Ordering Options Table

| Packaging Type <sup>1</sup>               | Packaging/Grade Ordering Code (C-Spec)  |
|---|---|
| Bulk Bag/Unmarked                         | Not required (Blank)  |
| 7" Reel/Unmarked                          | TU  |
| 13" Reel/Unmarked                         | 7411 (EIA 0603 and smaller case sizes)<br>7210 (EIA 0805 and larger case sizes) |
| 7" Reel/Marked                            | TM  |
| 13" Reel/Marked                           | 7040 (EIA 0603)<br>7215 (EIA 0805 and larger case sizes)                        |
| 7" Reel/Unmarked/2 mm pitch <sup>2</sup>  | 7081  |
| 13" Reel/Unmarked/2 mm pitch <sup>2</sup> | 7082  |

<sup>1</sup> Default packaging is "Bulk Bag." An ordering code C-Spec is not required for "Bulk Bag" packaging.

<sup>1</sup> The terms "Marked" and "Unmarked" pertain to laser marking option of capacitors. All packaging options labeled as "Unmarked" will contain capacitors that have not been laser marked. Please contact KEMET if you require a laser marked option. For more information see "Capacitor Marking."

<sup>2</sup> The 2 mm pitch option allows for double the packaging quantity of capacitors on a given reel size. This option is limited to EIA 0603 (1608 metric) case size devices. For more information regarding 2 mm pitch option see "Tape & Reel Packaging Information."

## Dimensions – Millimeters (Inches)



| EIA Size Code | Metric Size Code | L Length                      | W Width                       | T Thickness               | B Bandwidth                   | S Separation Minimum | Mounting Technique           |
|---------------|------------------|-------------------------------|-------------------------------|---------------------------|-------------------------------|----------------------|------------------------------|
| 0402          | 1005             | 1.00 (0.040)<br>±0.05 (0.002) | 0.50 (0.020)<br>±0.05 (0.002) | See Table 2 for Thickness | 0.30 (0.012)<br>±0.10 (0.004) | 0.30 (0.012)         | Solder reflow only           |
| 0603          | 1608             | 1.60 (0.063)<br>±0.15 (0.006) | 0.80 (0.032)<br>±0.15 (0.006) |                           | 0.35 (0.014)<br>±0.15 (0.006) | 0.70 (0.028)         | Solder wave or Solder reflow |
| 0805          | 2012             | 2.00 (0.079)<br>±0.20 (0.008) | 1.25 (0.049)<br>±0.20 (0.008) |                           | 0.50 (0.02)<br>±0.25 (0.010)  | 0.75 (0.030)         |                              |
| 1206          | 3216             | 3.20 (0.126)<br>±0.20 (0.008) | 1.60 (0.063)<br>±0.20 (0.008) |                           | 0.50 (0.02)<br>±0.25 (0.010)  | N/A                  | Solder reflow only           |
| 1210          | 3225             | 3.20 (0.126)<br>±0.20 (0.008) | 2.50 (0.098)<br>±0.20 (0.008) |                           | 0.50 (0.02)<br>±0.25 (0.010)  |                      |                              |
| 1808          | 4520             | 4.70 (0.185)<br>±0.50 (0.020) | 2.00 (0.079)<br>±0.20 (0.008) |                           | 0.60 (0.024)<br>±0.35 (0.014) |                      |                              |
| 1812          | 4532             | 4.50 (0.177)<br>±0.30 (0.012) | 3.20 (0.126)<br>±0.30 (0.012) |                           | 0.60 (0.024)<br>±0.35 (0.014) |                      |                              |
| 1825          | 4564             | 4.50 (0.177)<br>±0.30 (0.012) | 6.40 (0.252)<br>±0.40 (0.016) |                           | 0.60 (0.024)<br>±0.35 (0.014) |                      |                              |
| 2220          | 5650             | 5.70 (0.224)<br>±0.40 (0.016) | 5.00 (0.197)<br>±0.40 (0.016) |                           | 0.60 (0.024)<br>±0.35 (0.014) |                      |                              |
| 2225          | 5664             | 5.60 (0.220)<br>±0.40 (0.016) | 6.40 (0.248)<br>±0.40 (0.016) |                           | 0.60 (0.024)<br>±0.35 (0.014) |                      |                              |

## Qualification/Certification

Commercial grade products are subject to internal qualification. Details regarding test methods and conditions are referenced in Table 4, Performance & Reliability.

## Environmental Compliance

These devices do not meet RoHS criteria due to the concentration of Lead (Pb) in the termination finish.

## Electrical Parameters/Characteristics

| Item   | Parameters/Characteristics  |
|--|---|
| Operating Temperature Range  | -55°C to +125°C   |
| Capacitance Change with Reference to +25°C and 0 Vdc Applied (TCC) | ±15%  |
| <sup>1</sup> Aging Rate (Maximum % Capacitance Loss/Decade Hour)   | 3.0%  |
| <sup>2</sup> Dielectric Withstanding Voltage (DWV)                 | 250% of rated voltage<br>(5 ±1 seconds and charge/discharge not exceeding 50 mA)            |
| <sup>3</sup> Dissipation Factor (DF) Maximum Limit at 25°C         | 5% (6.3 V and 10 V), 3.5% (16 V and 25 V) and 2.5% (50 V to 250 V)                          |
| <sup>4</sup> Insulation Resistance (IR) Minimum Limit at 25°C      | See Insulation Resistance Limit Table<br>(Rated voltage applied for 120 ±5 seconds at 25°C) |

<sup>1</sup> Regarding Aging Rate: Capacitance measurements (including tolerance) are indexed to a referee time of 1,000 hours.

<sup>2</sup> DWV is the voltage a capacitor can withstand (survive) for a short period of time. It exceeds the nominal and continuous working voltage of the capacitor.

<sup>3</sup> Capacitance and dissipation factor (DF) measured under the following conditions:

1 kHz ±50 Hz and  $1.0 \pm 0.2 V_{rms}$  if capacitance  $\leq 10 \mu F$

120 Hz ±10 Hz and  $0.5 \pm 0.1 V_{rms}$  if capacitance  $> 10 \mu F$

<sup>4</sup> To obtain IR limit, divide  $M\Omega \cdot \mu F$  value by the capacitance and compare to  $G\Omega$  limit. Select the lower of the two limits.

Note: When measuring capacitance it is important to ensure the set voltage level is held constant. The HP4284 and Agilent E4980 have a feature known as Automatic Level Control (ALC). The ALC feature should be switched to "ON."

## Post Environmental Limits

| High Temperature Life, Biased Humidity, Moisture Resistance |                  |                   |                                |                   |                       |
|---|------------------|-------------------|--------------------------------|-------------------|-----------------------|
| Dielectric  | Rated DC Voltage | Capacitance Value | Dissipation Factor (Maximum %) | Capacitance Shift | Insulation Resistance |
| X7R   | > 25             | All               | 3.0                            | ±20%              | 10% of Initial limit  |
|   | 16/25            |                   | 5.0                            |                   |                       |
|   | < 16             |                   | 7.5                            |                   |                       |

## Insulation Resistance Limit Table

| EIA Case Size | Rated DC Voltage | 1,000 megohm microfarads or 100 GΩ | 500 megohm microfarads or 10 GΩ | 100 megohm microfarads or 10 GΩ |
|---------------|------------------|------------------------------------|---------------------------------|---------------------------------|
| 0201          | ALL              | N/A                                | ALL                             | N/A                             |
| 0402          | ALL              | < .012 μF                          | ≥ .012 μF                       | N/A                             |
| 0603          | ≤ 200 V          | < .047 μF                          | ≥ .047 μF                       | N/A                             |
|               | 250 V            | N/A                                | N/A                             | ALL                             |
| 0805          | ≤ 200 V          | < 0.15 μF                          | ≥ 0.15 μF                       | N/A                             |
|               | 250 V            | < .027 μF                          | N/A                             | ≥ .027 μF                       |
| 1206          | ≤200 V           | < 0.47 μF                          | ≥ 0.47 μF                       | N/A                             |
|               | 250 V            | < 0.12 μF                          | N/A                             | ≥ 0.12 μF                       |
| 1210          | ≤200 V           | < 0.39 μF                          | ≥ 0.39 μF                       | N/A                             |
|               | 250 V            | < 0.27 μF                          | N/A                             | ≥ 0.27 μF                       |
| 1808          | ALL              | ALL                                | N/A                             | N/A                             |
| 1812          | ALL              | < 2.2 μF                           | ≥ 2.2 μF                        | N/A                             |
| 1825          | ALL              | ALL                                | N/A                             | N/A                             |
| 2220          | ALL              | < 10 μF                            | ≥ 10 μF                         | N/A                             |
| 2225          | ALL              | ALL                                | N/A                             | N/A                             |

**Table 1A – Capacitance Range/Selection Waterfall (0402 – 1206 Case Sizes)**

| Cap            | Cap Code    | Case Size/<br>Series  |   | C0402C  |    |    |    |    | C0603C |    |    |    |    | C0805C |     |     |     |    | C1206C |    |    |    |     |     |     |     |    |    |    |    |    |     |     |     |
|----------------|-------------|-----------------------|---|---|----|----|----|----|--------|----|----|----|----|--------|-----|-----|-----|----|--------|----|----|----|-----|-----|-----|-----|----|----|----|----|----|-----|-----|-----|
|                |             | Voltage Code          |   | 9   | 8  | 4  | 3  | 5  | 9      | 8  | 4  | 3  | 5  | 1      | 2   | A   | 9   | 8  | 4      | 3  | 6  | 5  | 1   | 2   | A   | 9   | 8  | 4  | 3  | 6  | 5  | 1   | 2   | A   |
|                |             | Rated Voltage (VDC)   |   | 6.3   | 10 | 16 | 25 | 50 | 6.3    | 10 | 16 | 25 | 50 | 100    | 200 | 250 | 6.3 | 10 | 16     | 25 | 35 | 50 | 100 | 200 | 250 | 6.3 | 10 | 16 | 25 | 35 | 50 | 100 | 200 | 250 |
|                |             | Capacitance Tolerance |   | Product Availability and Chip Thickness Codes – See Table 2 for Chip Thickness Dimensions |    |    |    |    |        |    |    |    |    |        |     |     |     |    |        |    |    |    |     |     |     |     |    |    |    |    |    |     |     |     |
| 10 – 91 pF*    | 100 – 910*  | J                     | K | M   | BB | BB | BB | BB | BB     | CF | CF | CF | CF | CF     | CF  | DN  | DN  | DN | DN     | DN | DN | DN | DN  | DN  | EB  | EB  | EB | EB | EB | EB | EB | EB  | EB  |     |
| 100 – 150 pF** | 101 – 151** | J                     | K | M   | BB | BB | BB | BB | BB     | CF | CF | CF | CF | CF     | CF  | DN  | DN  | DN | DN     | DN | DN | DN | DN  | DN  | EB  | EB  | EB | EB | EB | EB | EB | EB  | EB  |     |
| 180 – 820 pF** | 181 – 821** | J                     | K | M   | BB | BB | BB | BB | BB     | CF | CF | CF | CF | CF     | CF  | DN  | DN  | DN | DN     | DN | DN | DN | DN  | DN  | EB  | EB  | EB | EB | EB | EB | EB | EB  | EB  |     |
| 1000 pF        | 102         | J                     | K | M   | BB | BB | BB | BB | BB     | CF | CF | CF | CF | CF     | CF  | DN  | DN  | DN | DN     | DN | DN | DN | DN  | DN  | EB  | EB  | EB | EB | EB | EB | EB | EB  | EB  |     |
| 1200 pF        | 122         | J                     | K | M   | BB | BB | BB | BB | BB     | CF | CF | CF | CF | CF     | CF  | DN  | DN  | DN | DN     | DN | DN | DN | DN  | DN  | EB  | EB  | EB | EB | EB | EB | EB | EB  | EB  |     |
| 1500 pF        | 152         | J                     | K | M   | BB | BB | BB | BB | BB     | CF | CF | CF | CF | CF     | CF  | DN  | DN  | DN | DN     | DN | DN | DN | DN  | DN  | EB  | EB  | EB | EB | EB | EB | EB | EB  | EB  |     |
| 1800 pF        | 182         | J                     | K | M   | BB | BB | BB | BB | BB     | CF | CF | CF | CF | CF     | CF  | DN  | DN  | DN | DN     | DN | DN | DN | DN  | DN  | EB  | EB  | EB | EB | EB | EB | EB | EB  | EB  |     |
| 2200 pF        | 222         | J                     | K | M   | BB | BB | BB | BB | BB     | CF | CF | CF | CF | CF     | CF  | DN  | DN  | DN | DN     | DN | DN | DN | DN  | DN  | EB  | EB  | EB | EB | EB | EB | EB | EB  | EB  |     |
| 2700 pF        | 272         | J                     | K | M   | BB | BB | BB | BB | BB     | CF | CF | CF | CF | CF     | CF  | DN  | DN  | DN | DN     | DN | DN | DN | DN  | DN  | EB  | EB  | EB | EB | EB | EB | EB | EB  | EB  |     |
| 3300 pF        | 332         | J                     | K | M   | BB | BB | BB | BB | BB     | CF | CF | CF | CF | CF     | CF  | DN  | DN  | DN | DN     | DN | DN | DN | DN  | DN  | EB  | EB  | EB | EB | EB | EB | EB | EB  | EB  |     |
| 3900 pF        | 392         | J                     | K | M   | BB | BB | BB | BB | BB     | CF | CF | CF | CF | CF     | CF  | DN  | DN  | DN | DN     | DN | DN | DN | DN  | DN  | EB  | EB  | EB | EB | EB | EB | EB | EB  | EB  |     |
| 4700 pF        | 472         | J                     | K | M   | BB | BB | BB | BB | BB     | CF | CF | CF | CF | CF     | CF  | DN  | DN  | DN | DN     | DN | DN | DN | DN  | DN  | EB  | EB  | EB | EB | EB | EB | EB | EB  | EB  |     |
| 5600 pF        | 562         | J                     | K | M   | BB | BB | BB | BB | BB     | CF | CF | CF | CF | CF     | CF  | DN  | DN  | DN | DN     | DN | DN | DN | DN  | DN  | EB  | EB  | EB | EB | EB | EB | EB | EB  | EB  |     |
| 6800 pF        | 682         | J                     | K | M   | BB | BB | BB | BB | BB     | CF | CF | CF | CF | CF     | CF  | DN  | DN  | DN | DN     | DN | DN | DN | DN  | DN  | EB  | EB  | EB | EB | EB | EB | EB | EB  | EB  |     |
| 8200 pF        | 822         | J                     | K | M   | BB | BB | BB | BB | BB     | CF | CF | CF | CF | CF     | CF  | DN  | DN  | DN | DN     | DN | DN | DN | DN  | DN  | EB  | EB  | EB | EB | EB | EB | EB | EB  | EB  |     |
| 10000 pF       | 103         | J                     | K | M   | BB | BB | BB | BB | BB     | CF | CF | CF | CF | CF     | CF  | DN  | DN  | DN | DN     | DN | DN | DN | DN  | DN  | EB  | EB  | EB | EB | EB | EB | EB | EB  | EB  |     |
| 12000 pF       | 123         | J                     | K | M   | BB | BB | BB | BB | BB     | CF | CF | CF | CF | CF     | CF  | DN  | DN  | DN | DN     | DN | DN | DN | DN  | DN  | EB  | EB  | EB | EB | EB | EB | EB | EB  | EB  |     |
| 15000 pF       | 153         | J                     | K | M   | BB | BB | BB | BB | BB     | CF | CF | CF | CF | CF     | CF  | DN  | DN  | DN | DN     | DN | DN | DN | DN  | DN  | EB  | EB  | EB | EB | EB | EB | EB | EB  | EB  |     |
| 18000 pF       | 183         | J                     | K | M   | BB | BB | BB | BB | BB     | CF | CF | CF | CF | CF     | CF  | DN  | DN  | DN | DN     | DN | DN | DN | DN  | DN  | EB  | EB  | EB | EB | EB | EB | EB | EB  | EB  |     |
| 22000 pF       | 223         | J                     | K | M   | BB | BB | BB | BB | BB     | CF | CF | CF | CF | CF     | CF  | DN  | DN  | DN | DN     | DN | DN | DN | DN  | DN  | EB  | EB  | EB | EB | EB | EB | EB | EB  | EB  |     |
| 27000 pF       | 273         | J                     | K | M   | BB | BB | BB | BB | BB     | CF | CF | CF | CF | CF     | CF  | DN  | DN  | DN | DN     | DN | DN | DN | DN  | DN  | EB  | EB  | EB | EB | EB | EB | EB | EB  | EB  |     |
| 33000 pF       | 333         | J                     | K | M   | BB | BB | BB | BB | BB     | CF | CF | CF | CF | CF     | CF  | DN  | DN  | DN | DN     | DN | DN | DN | DN  | DN  | EB  | EB  | EB | EB | EB | EB | EB | EB  | EB  |     |
| 39000 pF       | 393         | J                     | K | M   | BB | BB | BB | BB | BB     | CF | CF | CF | CF | CF     | CF  | DN  | DN  | DN | DN     | DN | DN | DN | DN  | DN  | EB  | EB  | EB | EB | EB | EB | EB | EB  | EB  |     |
| 47000 pF       | 473         | J                     | K | M   | BB | BB | BB | BB | BB     | CF | CF | CF | CF | CF     | CF  | DN  | DN  | DN | DN     | DN | DN | DN | DN  | DN  | EB  | EB  | EB | EB | EB | EB | EB | EB  | EB  |     |
| 56000 pF       | 563         | J                     | K | M   | BB | BB | BB | BB | BB     | CF | CF | CF | CF | CF     | CF  | DN  | DN  | DN | DN     | DN | DN | DN | DN  | DN  | EB  | EB  | EB | EB | EB | EB | EB | EB  | EB  |     |
| 68000 pF       | 683         | J                     | K | M   | BB | BB | BB | BB | BB     | CF | CF | CF | CF | CF     | CF  | DN  | DN  | DN | DN     | DN | DN | DN | DN  | DN  | EB  | EB  | EB | EB | EB | EB | EB | EB  | EB  |     |
| 82000 pF       | 823         | J                     | K | M   | BB | BB | BB | BB | BB     | CF | CF | CF | CF | CF     | CF  | DN  | DN  | DN | DN     | DN | DN | DN | DN  | DN  | EB  | EB  | EB | EB | EB | EB | EB | EB  | EB  |     |
| 0.1 μF         | 104         | J                     | K | M   | BB | BB | BB | BB | BB     | CF | CF | CF | CF | CF     | CF  | DN  | DN  | DN | DN     | DN | DN | DN | DN  | DN  | EB  | EB  | EB | EB | EB | EB | EB | EB  | EB  |     |
| 0.12 μF        | 124         | J                     | K | M   |    |    |    |    |        | CF | CF | CF | CF | CF     | CF  | DN  | DN  | DN | DN     | DN | DN | DN | DN  | DN  | EB  | EB  | EB | EB | EB | EB | EB | EB  | EB  |     |
| 0.15 μF        | 154         | J                     | K | M   |    |    |    |    |        | CF | CF | CF | CF | CF     | CF  | DN  | DN  | DN | DN     | DN | DN | DN | DN  | DN  | EB  | EB  | EB | EB | EB | EB | EB | EB  | EB  |     |
| 0.18 μF        | 184         | J                     | K | M   |    |    |    |    |        | CF | CF | CF | CF | CF     | CF  | DN  | DN  | DN | DN     | DN | DN | DN | DN  | DN  | EB  | EB  | EB | EB | EB | EB | EB | EB  | EB  |     |
| 0.22 μF        | 224         | J                     | K | M   |    |    |    |    |        | CF | CF | CF | CF | CF     | CF  | DN  | DN  | DN | DN     | DN | DN | DN | DN  | DN  | EB  | EB  | EB | EB | EB | EB | EB | EB  | EB  |     |
| 0.27 μF        | 274         | J                     | K | M   |    |    |    |    |        | CF | CF | CF | CF | CF     | CF  | DN  | DN  | DN | DN     | DN | DN | DN | DN  | DN  | EB  | EB  | EB | EB | EB | EB | EB | EB  | EB  |     |
| 0.33 μF        | 334         | J                     | K | M   |    |    |    |    |        | CF | CF | CF | CF | CF     | CF  | DN  | DN  | DN | DN     | DN | DN | DN | DN  | DN  | EB  | EB  | EB | EB | EB | EB | EB | EB  | EB  |     |
| 0.39 μF        | 394         | J                     | K | M   |    |    |    |    |        | CF | CF | CF | CF | CF     | CF  | DN  | DN  | DN | DN     | DN | DN | DN | DN  | DN  | EB  | EB  | EB | EB | EB | EB | EB | EB  | EB  |     |
| 0.47 μF        | 474         | J                     | K | M   |    |    |    |    |        | CF | CF | CF | CF | CF     | CF  | DN  | DN  | DN | DN     | DN | DN | DN | DN  | DN  | EB  | EB  | EB | EB | EB | EB | EB | EB  | EB  |     |
| 0.56 μF        | 564         | J                     | K | M   |    |    |    |    |        |    |    |    |    |        |     | DP  | DP  | DP | DP     | DP | DP | DP | DP  | DP  | EB  | EB  | EB | EB | EB | EB | EB | EB  | EB  |     |
| 0.68 μF        | 684         | J                     | K | M   |    |    |    |    |        |    |    |    |    |        |     | DP  | DP  | DP | DP     | DP | DP | DP | DP  | DP  | EB  | EB  | EB | EB | EB | EB | EB | EB  | EB  |     |
| 0.82 μF        | 824         | J                     | K | M   |    |    |    |    |        |    |    |    |    |        |     | DP  | DP  | DP | DP     | DP | DP | DP | DP  | DP  | EB  | EB  | EB | EB | EB | EB | EB | EB  | EB  |     |
| 1 μF           | 105         | J                     | K | M   |    |    |    |    |        |    |    |    |    |        |     | DP  | DP  | DP | DP     | DP | DP | DP | DP  | DP  | EB  | EB  | EB | EB | EB | EB | EB | EB  | EB  |     |
| 1.2 μF         | 125         | J                     | K | M   |    |    |    |    |        |    |    |    |    |        |     | DE  | DE  | DE | DE     | DE | DE | DE | DE  | DE  | EB  | EB  | EB | EB | EB | EB | EB | EB  | EB  |     |
| 1.5 μF         | 155         | J                     | K | M   |    |    |    |    |        |    |    |    |    |        |     | DG  | DG  | DG | DG     | DG | DG | DG | DG  | DG  | EB  | EB  | EB | EB | EB | EB | EB | EB  | EB  |     |
| 1.8 μF         | 185         | J                     | K | M   |    |    |    |    |        |    |    |    |    |        |     | DG  | DG  | DG | DG     | DG | DG | DG | DG  | DG  | EB  | EB  | EB | EB | EB | EB | EB | EB  | EB  |     |
| 2.2 μF         | 225         | J                     | K | M   |    |    |    |    |        |    |    |    |    |        |     | DG  | DG  | DG | DG     | DG | DG | DG | DG  | DG  | EB  | EB  | EB | EB | EB | EB | EB | EB  | EB  |     |
| 2.7 μF         | 275         | J                     | K | M   |    |    |    |    |        |    |    |    |    |        |     | DG  | DG  | DG | DG     | DG | DG | DG | DG  | DG  | EB  | EB  | EB | EB | EB | EB | EB | EB  | EB  |     |
| 3.3 μF         | 335         | J                     | K | M   |    |    |    |    |        |    |    |    |    |        |     |     |     |    |        |    |    |    |     |     | ED  | ED  | ED | ED | ED | ED | ED | ED  | ED  |     |
| 3.9 μF         | 395         | J                     | K | M   |    |    |    |    |        |    |    |    |    |        |     |     |     |    |        |    |    |    |     |     | EF  | EF  | EF | EF | EF | EF | EF | EF  | EF  |     |
| 4.7 μF         | 475         | J                     | K | M   |    |    |    |    |        |    |    |    |    |        |     |     |     |    |        |    |    |    |     |     | EF  | EF  | EF | EF | EF | EF | EF | EF  | EF  |     |
| 5.6 μF         | 565         | J                     | K | M   |    |    |    |    |        |    |    |    |    |        |     |     |     |    |        |    |    |    |     |     | EH  | EH  | EH | EH | EH | EH | EH | EH  | EH  |     |
| 6.8 μF         | 685         | J                     | K | M   |    |    |    |    |        |    |    |    |    |        |     |     |     |    |        |    |    |    |     |     | EH  | EH  | EH | EH | EH | EH | EH | EH  | EH  |     |
| 8.2 μF         | 825         | J                     | K | M   |    |    |    |    |        |    |    |    |    |        |     |     |     |    |        |    |    |    |     |     | EH  | EH  | EH | EH | EH | EH | EH | EH  | EH  |     |
| 10 μF          | 106         | J                     | K | M   |    |    |    |    |        |    |    |    |    |        |     |     |     |    |        |    |    |    |     |     | EH  | EH  | EH | EH | EH | EH | EH | EH  | EH  |     |
| Cap            | Cap Code    | Rated Voltage (VDC)   |   | 6.3   | 10 | 16 | 25 | 50 | 6.3    | 10 | 16 | 25 | 50 | 100    | 200 | 250 | 6.3 | 10 | 16     | 25 | 35 | 50 | 100 | 200 | 250 | 6.3 | 10 | 16 | 25 | 35 | 50 | 100 | 200 | 250 |
|                |             | Voltage Code          |   | 9   | 8  | 4  | 3  | 5  | 9      | 8  | 4  | 3  | 5  | 1      | 2   | A   | 9   | 8  | 4      | 3  | 6  | 5  | 1   | 2   | A   | 9   | 8  | 4  | 3  | 6  | 5  | 1   | 2   | A   |
|                |             | Case Size/<br>Series  |   |   |    |    |    |    |        |    |    |    |    |        |     |     |     |    |        |    |    |    |     |     |     |     |    |    |    |    |    |     |     |     |



**Table 1B – Capacitance Range/Selection Waterfall (1210 – 2225 Case Sizes) cont'd**

| Cap   | Cap Code | Case Size/ Series     | C1210C  |                 |                 |    |    |     |     |     | C1808C |     |     | C1812C |    |     |     |     | C1825C |     |     |     | C2220C |    |     |     |     | C2225C |     |     |     |  |  |  |
|-------|----------|-----------------------|---|-----------------|-----------------|----|----|-----|-----|-----|--------|-----|-----|--------|----|-----|-----|-----|--------|-----|-----|-----|--------|----|-----|-----|-----|--------|-----|-----|-----|--|--|--|
|       |          | Voltage Code          | 9   | 8               | 4               | 3  | 5  | 1   | 2   | A   | 5      | 1   | 2   | 3      | 5  | 1   | 2   | A   | 5      | 1   | 2   | A   | 3      | 5  | 1   | 2   | A   | 5      | 1   | 2   | A   |  |  |  |
|       |          | Rated Voltage (VDC)   | 6.3   | 10              | 16              | 25 | 50 | 100 | 200 | 250 | 50     | 100 | 200 | 25     | 50 | 100 | 200 | 250 | 50     | 100 | 200 | 250 | 25     | 50 | 100 | 200 | 250 | 50     | 100 | 200 | 250 |  |  |  |
|       |          | Capacitance Tolerance | Product Availability and Chip Thickness Codes – See Table 2 for Chip Thickness Dimensions |                 |                 |    |    |     |     |     |        |     |     |        |    |     |     |     |        |     |     |     |        |    |     |     |     |        |     |     |     |  |  |  |
| 10 µF | 106      | J K M                 | FH <sup>1</sup>   | FH <sup>1</sup> | FH <sup>1</sup> | FS |    |     |     |     |        |     |     |        |    |     | GK  |     |        |     |     |     |        |    |     |     | JF  | JO     |     |     |     |  |  |  |
| 12 µF | 126      | J K M                 |   |                 |                 |    |    |     |     |     |        |     |     |        |    |     |     |     |        |     |     |     |        |    |     |     |     |        |     |     |     |  |  |  |
| 15 µF | 156      | J K M                 | FM  | FM              |                 |    |    |     |     |     |        |     |     |        |    |     |     |     |        |     |     |     |        |    |     | JO  | JO  |        |     |     |     |  |  |  |
| 18 µF | 186      | J K M                 |   |                 |                 |    |    |     |     |     |        |     |     |        |    |     |     |     |        |     |     |     |        |    |     |     |     |        |     |     |     |  |  |  |
| 22 µF | 226      | J K M                 | FS  | FS              |                 |    |    |     |     |     |        |     |     |        |    |     |     |     |        |     |     |     |        |    |     | JO  |     |        |     |     |     |  |  |  |
| Cap   | Cap Code | Rated Voltage (VDC)   | 6.3   | 10              | 16              | 25 | 50 | 100 | 200 | 250 | 50     | 100 | 200 | 25     | 50 | 100 | 200 | 250 | 50     | 100 | 200 | 250 | 25     | 50 | 100 | 200 | 250 | 50     | 100 | 200 | 250 |  |  |  |
|       |          | Voltage Code          | 9   | 8               | 4               | 3  | 5  | 1   | 2   | A   | 5      | 1   | 2   | 3      | 5  | 1   | 2   | A   | 5      | 1   | 2   | A   | 3      | 5  | 1   | 2   | A   | 5      | 1   | 2   | A   |  |  |  |
|       |          | Case Size/ Series     | C1210C  |                 |                 |    |    |     |     |     | C1808C |     |     | C1812C |    |     |     |     | C1825C |     |     |     | C2220C |    |     |     |     | C2225C |     |     |     |  |  |  |

\*Capacitance range Includes E24 decade values only. (i.e., 10, 11, 12, 13, 15, 16, 18, 20, 22, 24, 27, 30, 33, 36, 39, 43, 47, 51, 56, 62, 68, 75, 82 and 91).

\*\*Capacitance range Includes E12 decade values only. (i.e., 10, 12, 15, 18, 22, 27, 33, 39, 47, 56, 68 and 82).

**Table 2A – Chip Thickness/Tape & Reel Packaging Quantities**

| Thickness Code | Case Size <sup>1</sup> | Thickness ± Range (mm) | Paper Quantity <sup>1</sup> |          | Plastic Quantity |          |
|----------------|------------------------|------------------------|-----------------------------|----------|------------------|----------|
|                |                        |                        | 7" Reel                     | 13" Reel | 7" Reel          | 13" Reel |
| BB             | 0402                   | 0.50 ±0.05             | 10,000                      | 50,000   | 0                | 0        |
| CF             | 0603                   | 0.80 ±0.07*            | 4,000                       | 15,000   | 0                | 0        |
| DN             | 0805                   | 0.78 ±0.10*            | 4,000                       | 15,000   | 0                | 0        |
| DP             | 0805                   | 0.90 ±0.10*            | 4,000                       | 15,000   | 0                | 0        |
| DE             | 0805                   | 1.00 ±0.10             | 0                           | 0        | 2,500            | 10,000   |
| DG             | 0805                   | 1.25 ±0.15             | 0                           | 0        | 2,500            | 10,000   |
| DH             | 0805                   | 1.25 ±0.20             | 0                           | 0        | 2,500            | 10,000   |
| EB             | 1206                   | 0.78 ±0.10             | 4,000                       | 10,000   | 4,000            | 10,000   |
| EC             | 1206                   | 0.90 ±0.10             | 0                           | 0        | 4,000            | 10,000   |
| EN             | 1206                   | 0.95 ±0.10             | 0                           | 0        | 4,000            | 10,000   |
| ED             | 1206                   | 1.00 ±0.10             | 0                           | 0        | 2,500            | 10,000   |
| EE             | 1206                   | 1.10 ±0.10             | 0                           | 0        | 2,500            | 10,000   |
| EF             | 1206                   | 1.20 ±0.15             | 0                           | 0        | 2,500            | 10,000   |
| EM             | 1206                   | 1.25 ±0.15             | 0                           | 0        | 2,500            | 10,000   |
| EG             | 1206                   | 1.60 ±0.15             | 0                           | 0        | 2,000            | 8,000    |
| EH             | 1206                   | 1.60 ±0.20             | 0                           | 0        | 2,000            | 8,000    |
| FB             | 1210                   | 0.78 ±0.10             | 0                           | 0        | 4,000            | 10,000   |
| FC             | 1210                   | 0.90 ±0.10             | 0                           | 0        | 4,000            | 10,000   |
| FD             | 1210                   | 0.95 ±0.10             | 0                           | 0        | 4,000            | 10,000   |
| FE             | 1210                   | 1.00 ±0.10             | 0                           | 0        | 2,500            | 10,000   |
| FF             | 1210                   | 1.10 ±0.10             | 0                           | 0        | 2,500            | 10,000   |
| FG             | 1210                   | 1.25 ±0.15             | 0                           | 0        | 2,500            | 10,000   |
| FL             | 1210                   | 1.40 ±0.15             | 0                           | 0        | 2,000            | 8,000    |
| Thickness Code | Case Size <sup>1</sup> | Thickness ± Range (mm) | 7" Reel                     | 13" Reel | 7" Reel          | 13" Reel |
|                |                        |                        | Paper Quantity <sup>1</sup> |          | Plastic Quantity |          |

Package quantity based on finished chip thickness specifications.

<sup>1</sup> If ordering using the 2 mm Tape and Reel pitch option, the packaging quantity outlined in the table above will be doubled. This option is limited to EIA 0603 (1608 metric) case size devices. For more information regarding 2 mm pitch option see "Tape & Reel Packaging Information".



**Table 2A – Chip Thickness/Tape & Reel Packaging Quantities cont'd**

| Thickness Code | Case Size <sup>1</sup> | Thickness ± Range (mm) | Paper Quantity <sup>1</sup> |          | Plastic Quantity |          |
|----------------|------------------------|------------------------|-----------------------------|----------|------------------|----------|
|                |                        |                        | 7" Reel                     | 13" Reel | 7" Reel          | 13" Reel |
| FH             | 1210                   | 1.55 ±0.15             | 0                           | 0        | 2,000            | 8,000    |
| FP             | 1210                   | 1.60 ±0.20             | 0                           | 0        | 2,000            | 8,000    |
| FM             | 1210                   | 1.70 ±0.20             | 0                           | 0        | 2,000            | 8,000    |
| FJ             | 1210                   | 1.85 ±0.20             | 0                           | 0        | 2,000            | 8,000    |
| FK             | 1210                   | 2.10 ±0.20             | 0                           | 0        | 2,000            | 8,000    |
| FS             | 1210                   | 2.50 ±0.30             | 0                           | 0        | 1,000            | 4,000    |
| NA             | 1706                   | 0.90 ±0.10             | 0                           | 0        | 4,000            | 10,000   |
| NC             | 1706                   | 1.00 ±0.15             | 0                           | 0        | 4,000            | 10,000   |
| LD             | 1808                   | 0.90 ±0.10             | 0                           | 0        | 2,500            | 10,000   |
| LF             | 1808                   | 1.00 ±0.15             | 0                           | 0        | 2,500            | 10,000   |
| GB             | 1812                   | 1.00 ±0.10             | 0                           | 0        | 1,000            | 4,000    |
| GC             | 1812                   | 1.10 ±0.10             | 0                           | 0        | 1,000            | 4,000    |
| GD             | 1812                   | 1.25 ±0.15             | 0                           | 0        | 1,000            | 4,000    |
| GE             | 1812                   | 1.30 ±0.10             | 0                           | 0        | 1,000            | 4,000    |
| GH             | 1812                   | 1.40 ±0.15             | 0                           | 0        | 1,000            | 4,000    |
| GG             | 1812                   | 1.55 ±0.10             | 0                           | 0        | 1,000            | 4,000    |
| GK             | 1812                   | 1.60 ±0.20             | 0                           | 0        | 1,000            | 4,000    |
| GJ             | 1812                   | 1.70 ±0.15             | 0                           | 0        | 1,000            | 4,000    |
| GL             | 1812                   | 1.90 ±0.20             | 0                           | 0        | 500              | 2,000    |
| GO             | 1812                   | 2.50 ±0.20             | 0                           | 0        | 500              | 2,000    |
| HB             | 1825                   | 1.10 ±0.15             | 0                           | 0        | 1,000            | 4,000    |
| HC             | 1825                   | 1.15 ±0.15             | 0                           | 0        | 1,000            | 4,000    |
| HD             | 1825                   | 1.30 ±0.15             | 0                           | 0        | 1,000            | 4,000    |
| HE             | 1825                   | 1.40 ±0.15             | 0                           | 0        | 1,000            | 4,000    |
| HF             | 1825                   | 1.50 ±0.15             | 0                           | 0        | 1,000            | 4,000    |
| JB             | 2220                   | 1.00 ±0.15             | 0                           | 0        | 1,000            | 4,000    |
| JC             | 2220                   | 1.10 ±0.15             | 0                           | 0        | 1,000            | 4,000    |
| JD             | 2220                   | 1.30 ±0.15             | 0                           | 0        | 1,000            | 4,000    |
| JE             | 2220                   | 1.40 ±0.15             | 0                           | 0        | 1,000            | 4,000    |
| JF             | 2220                   | 1.50 ±0.15             | 0                           | 0        | 1,000            | 4,000    |
| JO             | 2220                   | 2.40 ±0.15             | 0                           | 0        | 500              | 2,000    |
| KB             | 2225                   | 1.00 ±0.15             | 0                           | 0        | 1,000            | 4,000    |
| KC             | 2225                   | 1.10 ±0.15             | 0                           | 0        | 1,000            | 4,000    |
| KD             | 2225                   | 1.30 ±0.15             | 0                           | 0        | 1,000            | 4,000    |
| KE             | 2225                   | 1.40 ±0.15             | 0                           | 0        | 1,000            | 4,000    |
| Thickness Code | Case Size <sup>1</sup> | Thickness ± Range (mm) | 7" Reel                     | 13" Reel | 7" Reel          | 13" Reel |
|                |                        |                        | Paper Quantity <sup>1</sup> |          | Plastic Quantity |          |

Package quantity based on finished chip thickness specifications.

<sup>1</sup> If ordering using the 2 mm Tape and Reel pitch option, the packaging quantity outlined in the table above will be doubled. This option is limited to EIA 0603 (1608 metric) case size devices. For more information regarding 2 mm pitch option see "Tape & Reel Packaging Information."

**Table 2B – Bulk Packaging Quantities**

| Packaging Type                |             | Loose Packaging                              |         |
|-------------------------------|-------------|--|---------|
|                               |             | Bulk Bag (default)                           |         |
| Packaging C-Spec <sup>1</sup> |             | N/A <sup>2</sup>                             |         |
| Case Size                     |             | Packaging Quantities (pieces/unit packaging) |         |
| EIA (in)                      | Metric (mm) | Minimum                                      | Maximum |
| 0402                          | 1005        | 1  | 50,000  |
| 0603                          | 1608        |  |         |
| 0805                          | 2012        |  |         |
| 1206                          | 3216        |  |         |
| 1210                          | 3225        |  |         |
| 1808                          | 4520        |  | 20,000  |
| 1812                          | 4532        |  |         |
| 1825                          | 4564        |  |         |
| 2220                          | 5650        |  |         |
| 2225                          | 5664        |  |         |

<sup>1</sup> The "Packaging C-Spec" is a 4 to 8 digit code which identifies the packaging type and/or product grade. When ordering, the proper code must be included in the 15th through 22nd character positions of the ordering code. See "Ordering Information" section of this document for further details. Commercial grade product ordered without a packaging C-Spec will default to our standard "Bulk Bag" packaging. Contact KEMET if you require a bulk bag packaging option for automotive grade products.

<sup>2</sup> A packaging C-Spec (see note 1 above) is not required for "Bulk Bag" packaging (excluding anti-static Bulk Bag and automotive grade products). The 15th through 22nd character positions of the ordering code should be left blank. All product ordered without a packaging C-Spec will default to our standard "Bulk Bag" packaging.

**Table 3 – Chip Capacitor Land Pattern Design Recommendations per IPC–7351**

| EIA Size Code     | Metric Size Code | Density Level A:<br>Maximum (Most)<br>Land Protrusion (mm) |      |      |      |      | Density Level B:<br>Median (Nominal)<br>Land Protrusion (mm) |      |      |      |      | Density Level C:<br>Minimum (Least)<br>Land Protrusion (mm) |      |      |      |      |
|-------------------|------------------|--|------|------|------|------|--|------|------|------|------|---|------|------|------|------|
|                   |                  | C  | Y    | X    | V1   | V2   | C  | Y    | X    | V1   | V2   | C   | Y    | X    | V1   | V2   |
| 0402              | 1005             | 0.50   | 0.72 | 0.72 | 2.20 | 1.20 | 0.45   | 0.62 | 0.62 | 1.90 | 1.00 | 0.40  | 0.52 | 0.52 | 1.60 | 0.80 |
| 0603              | 1608             | 0.90   | 1.15 | 1.10 | 4.00 | 2.10 | 0.80   | 0.95 | 1.00 | 3.10 | 1.50 | 0.60  | 0.75 | 0.90 | 2.40 | 1.20 |
| 0805              | 2012             | 1.00   | 1.35 | 1.55 | 4.40 | 2.60 | 0.90   | 1.15 | 1.45 | 3.50 | 2.00 | 0.75  | 0.95 | 1.35 | 2.80 | 1.70 |
| 1206              | 3216             | 1.60   | 1.35 | 1.90 | 5.60 | 2.90 | 1.50   | 1.15 | 1.80 | 4.70 | 2.30 | 1.40  | 0.95 | 1.70 | 4.00 | 2.00 |
| 1210              | 3225             | 1.60   | 1.35 | 2.80 | 5.65 | 3.80 | 1.50   | 1.15 | 2.70 | 4.70 | 3.20 | 1.40  | 0.95 | 2.60 | 4.00 | 2.90 |
| 1210 <sup>1</sup> | 3225             | 1.50   | 1.60 | 2.90 | 5.60 | 3.90 | 1.40   | 1.40 | 2.80 | 4.70 | 3.30 | 1.30  | 1.20 | 2.70 | 4.00 | 3.00 |
| 1808              | 4520             | 2.30   | 1.75 | 2.30 | 7.40 | 3.30 | 2.20   | 1.55 | 2.20 | 6.50 | 2.70 | 2.10  | 1.35 | 2.10 | 5.80 | 2.40 |
| 1812              | 4532             | 2.15   | 1.60 | 3.60 | 6.90 | 4.60 | 2.05   | 1.40 | 3.50 | 6.00 | 4.00 | 1.95  | 1.20 | 3.40 | 5.30 | 3.70 |
| 1825              | 4564             | 2.15   | 1.60 | 6.90 | 6.90 | 7.90 | 2.05   | 1.40 | 6.80 | 6.00 | 7.30 | 1.95  | 1.20 | 6.70 | 5.30 | 7.00 |
| 2220              | 5650             | 2.75   | 1.70 | 5.50 | 8.20 | 6.50 | 2.65   | 1.50 | 5.40 | 7.30 | 5.90 | 2.55  | 1.30 | 5.30 | 6.60 | 5.60 |
| 2225              | 5664             | 2.70   | 1.70 | 6.90 | 8.10 | 7.90 | 2.60   | 1.50 | 6.80 | 7.20 | 7.30 | 2.50  | 1.30 | 6.70 | 6.50 | 7.00 |

<sup>1</sup> Only for capacitance values  $\geq 22 \mu\text{F}$

**Density Level A:** For low-density product applications. Recommended for wave solder applications and provides a wider process window for reflow solder processes. KEMET only recommends wave soldering of EIA 0603, 0805 and 1206 case sizes.

**Density Level B:** For products with a moderate level of component density. Provides a robust solder attachment condition for reflow solder processes.

**Density Level C:** For high component density product applications. Before adapting the minimum land pattern variations the user should perform qualification testing based on the conditions outlined in IPC Standard 7351 (IPC-7351).

Image below based on Density Level B for an EIA 1210 case size.

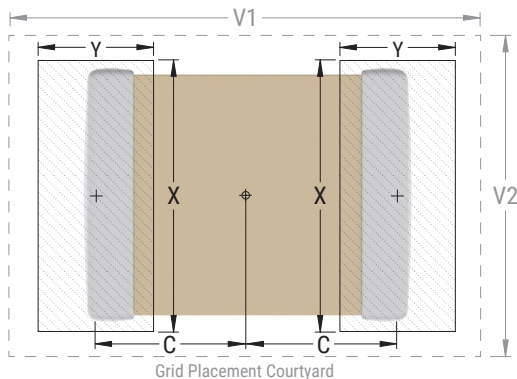

## Soldering Process

### Recommended Soldering Technique:

- Solder wave or solder reflow for EIA case sizes 0603, 0805 and 1206
- All other EIA case sizes are limited to solder reflow only

### Recommended Reflow Soldering Profile:

The KEMET families of surface mount multilayer ceramic capacitors (SMD MLCCs) are compatible with wave (single or dual), convection, IR or vapor phase reflow techniques. Preheating of these components is recommended to avoid extreme thermal stress. KEMET's recommended profile conditions for convection and IR reflow reflect the profile conditions of the IPC/J-STD-020 standard for moisture sensitivity testing. These devices can safely withstand a maximum of three reflow passes at these conditions.

| Profile Feature                                       | Termination Finish |                    |
|---|--------------------|--------------------|
|   | SnPb               | 100% Matte Sn      |
| <b>Preheat/Soak</b>                                   |                    |                    |
| Temperature Minimum ( $T_{Smin}$ )                    | 100°C              | 150°C              |
| Temperature Maximum ( $T_{Smax}$ )                    | 150°C              | 200°C              |
| Time ( $t_s$ ) from $T_{Smin}$ to $T_{Smax}$          | 60 – 120 seconds   | 60 – 120 seconds   |
| Ramp-Up Rate ( $T_L$ to $T_p$ )                       | 3°C/second maximum | 3°C/second maximum |
| Liquidous Temperature ( $T_L$ )                       | 183°C              | 217°C              |
| Time Above Liquidous ( $t_L$ )                        | 60 – 150 seconds   | 60 – 150 seconds   |
| Peak Temperature ( $T_p$ )                            | 235°C              | 260°C              |
| Time Within 5°C of Maximum Peak Temperature ( $t_p$ ) | 20 seconds maximum | 30 seconds maximum |
| Ramp-Down Rate ( $T_p$ to $T_L$ )                     | 6°C/second maximum | 6°C/second maximum |
| Time 25°C to Peak Temperature                         | 6 minutes maximum  | 8 minutes maximum  |

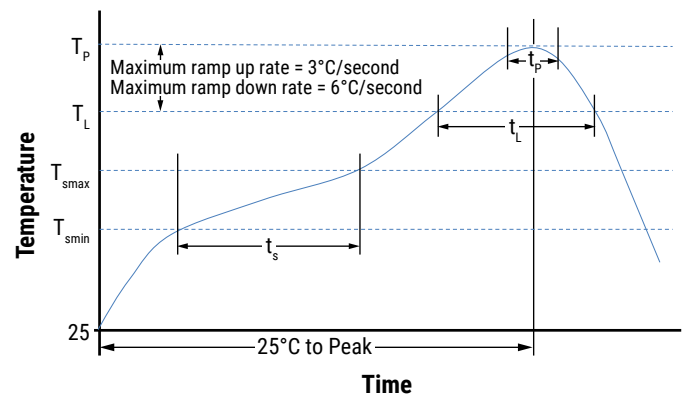

Note: All temperatures refer to the center of the package, measured on the capacitor body surface that is facing up during assembly reflow.

**Table 4 – Performance & Reliability: Test Methods and Conditions**

| Stress                 | Reference                      | Test or Inspection Method  |
|------------------------|--------------------------------|--|
| Terminal Strength      | JIS-C-6429                     | Appendix 1, Note: Force of 1.8 kg for 60 seconds.  |
| Board Flex             | JIS-C-6429                     | Appendix 2, Note: Standard termination system – 2.0 mm (minimum) for all except 3 mm for COG. Flexible termination system – 3.0 mm (minimum).  |
| Solderability          | J-STD-002                      | Magnification 50 X, conditions:  |
|                        |                                | a) Method B, 4 hours at 155°C, dry heat at 235°C   |
|                        |                                | b) Method B, category 3 at 215°C   |
|                        |                                | c) Method D, category 3 at 260°C   |
| Temperature Cycling    | JESD22 Method JA-104           | 1,000 Cycles (-55°C to +125°C). Measurement at 24 hours ±4 hours after test conclusion.  |
| Biased Humidity        | MIL-STD-202 Method 103         | Load humidity: 1,000 hours 85°C/85% RH and rated voltage. Add 100 K ohm resistor. Measurement at 24 hours ±4 hours after test conclusion.  |
|                        |                                | Low volt humidity: 1,000 hours 85°C/85% RH and 1.5 V. Add 100 K ohm resistor. Measurement at 24 hours ±4 hours after test conclusion.  |
| Moisture Resistance    | MIL-STD-202 Method 106         | t = 24 hours/cycle. Steps 7a and 7b not required. Measurement at 24 hours ±4 hours after test conclusion.  |
| Thermal Shock          | MIL-STD-202 Method 107         | -55°C/+125°C. Note: Number of cycles required – 300. Maximum transfer time – 20 seconds. Dwell time – 15 minutes. Air – air.   |
| High Temperature Life  | MIL-STD-202 Method 108/EIA-198 | 1,000 hours at 125°C (85°C for X5R, Z5U and Y5V) with 2 X rated voltage applied.   |
| Storage Life           | MIL-STD-202 Method 108         | 150°C, 0 VDC for 1,000 hours.  |
| Vibration              | MIL-STD-202 Method 204         | 5 g's for 20 minutes, 12 cycles each of 3 orientations. Note: Use 8" X 5" PCB 0.031" thick 7 secure points on one long side and 2 secure points at corners of opposite sides. Parts mounted within 2" from any secure point. Test from 10 – 2,000 Hz |
| Mechanical Shock       | MIL-STD-202 Method 213         | Figure 1 of Method 213, Condition F.   |
| Resistance to Solvents | MIL-STD-202 Method 215         | Add aqueous wash chemical, OKEM Clean or equivalent.   |

## Storage & Handling

Ceramic chip capacitors should be stored in normal working environments. While the chips themselves are quite robust in other environments, solderability will be degraded by exposure to high temperatures, high humidity, corrosive atmospheres, and long term storage. In addition, packaging materials will be degraded by high temperature – reels may soften or warp and tape peel force may increase. KEMET recommends that maximum storage temperature not exceed 40°C and maximum storage humidity not exceed 70% relative humidity. Temperature fluctuations should be minimized to avoid condensation on the parts and atmospheres should be free of chlorine and sulfur bearing compounds. For optimized solderability chip stock should be used promptly, preferably within 1.5 years of receipt.

## Construction

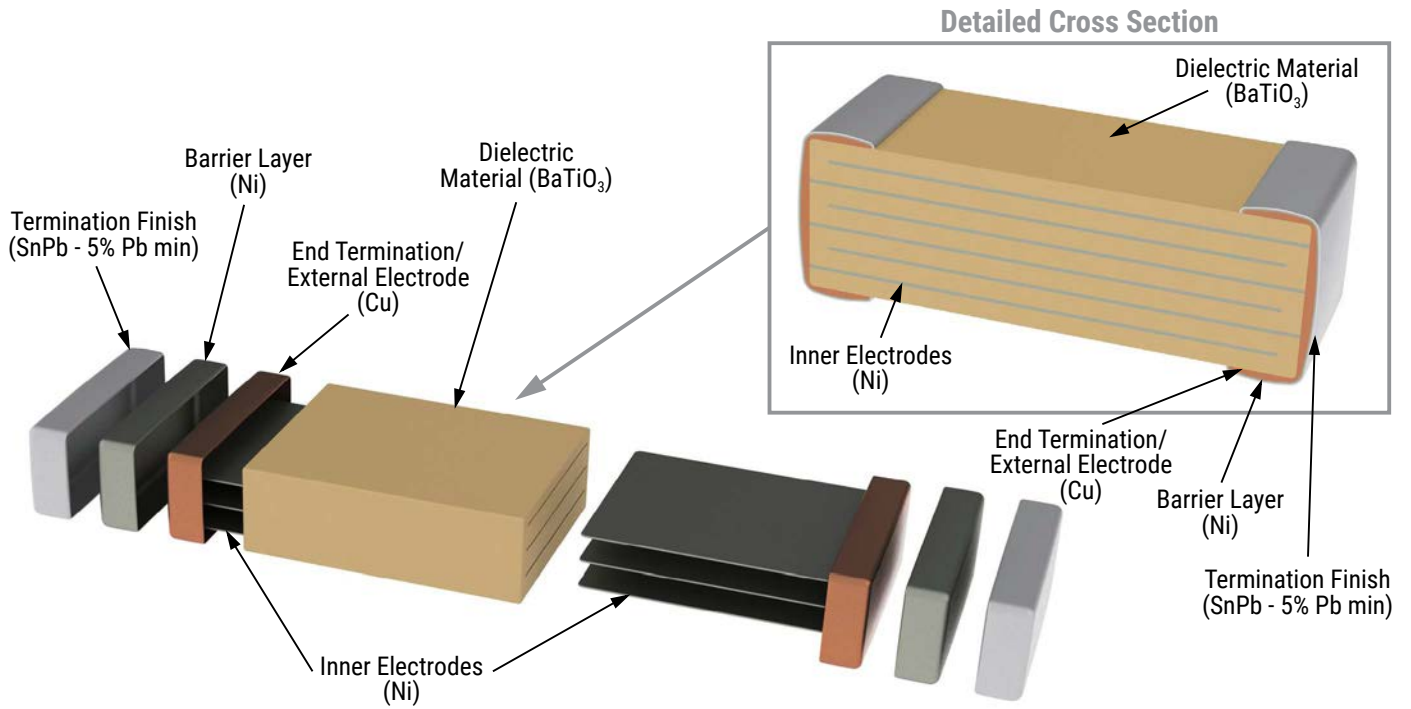

## Capacitor Marking (Optional):

These surface mount multilayer ceramic capacitors are normally supplied unmarked. If required, they can be marked as an extra cost option. Marking is available on most KEMET devices, but must be requested using the correct ordering code identifier(s). If this option is requested, two sides of the ceramic body will be laser marked with a "K" to identify KEMET, followed by two characters (per EIA-198 - see table below) to identify the capacitance value. EIA 0603 case size devices are limited to the "K" character only.

Laser marking option is not available on:

- COG, ultra stable X8R and Y5V dielectric devices.
- EIA 0402 case size devices.
- EIA 0603 case size devices with flexible termination option.
- KPS commercial and automotive grade stacked devices.
- X7R dielectric products in capacitance values outlined below.

Marking appears in legible contrast. Illustrated below is an example of an MLCC with laser marking of "KA8", which designates a KEMET device with rated capacitance of 100  $\mu$ F. Orientation of marking is vendor optional.

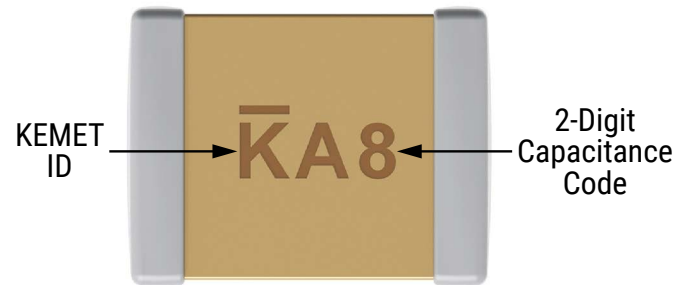

| EIA Case Size | Metric Size Code | Capacitance          |
|---------------|------------------|----------------------|
| 0603          | 1608             | $\leq 170$ pF        |
| 0805          | 2012             | $\leq 150$ pF        |
| 1206          | 3216             | $\leq 910$ pF        |
| 1210          | 3225             | $\leq 2,000$ pF      |
| 1808          | 4520             | $\leq 3,900$ pF      |
| 1812          | 4532             | $\leq 6,700$ pF      |
| 1825          | 4564             | $\leq 0.018$ $\mu$ F |
| 2220          | 5650             | $\leq 0.027$ $\mu$ F |
| 2225          | 5664             | $\leq 0.033$ $\mu$ F |

## Capacitor Marking (Optional) cont'd

| Capacitance (pF) For Various Alpha/Numeral Identifiers |         |     |    |     |       |        |         |           |            |             |
|--|---------|-----|----|-----|-------|--------|---------|-----------|------------|-------------|
| Alpha Character  | Numeral |     |    |     |       |        |         |           |            |             |
|  | 9       | 0   | 1  | 2   | 3     | 4      | 5       | 6         | 7          | 8           |
| Capacitance (pF)                                       |         |     |    |     |       |        |         |           |            |             |
| A  | 0.10    | 1.0 | 10 | 100 | 1,000 | 10,000 | 100,000 | 1,000,000 | 10,000,000 | 100,000,000 |
| B  | 0.11    | 1.1 | 11 | 110 | 1,100 | 11,000 | 110,000 | 1,100,000 | 11,000,000 | 110,000,000 |
| C  | 0.12    | 1.2 | 12 | 120 | 1,200 | 12,000 | 120,000 | 1,200,000 | 12,000,000 | 120,000,000 |
| D  | 0.13    | 1.3 | 13 | 130 | 1,300 | 13,000 | 130,000 | 1,300,000 | 13,000,000 | 130,000,000 |
| E  | 0.15    | 1.5 | 15 | 150 | 1,500 | 15,000 | 150,000 | 1,500,000 | 15,000,000 | 150,000,000 |
| F  | 0.16    | 1.6 | 16 | 160 | 1,600 | 16,000 | 160,000 | 1,600,000 | 16,000,000 | 160,000,000 |
| G  | 0.18    | 1.8 | 18 | 180 | 1,800 | 18,000 | 180,000 | 1,800,000 | 18,000,000 | 180,000,000 |
| H  | 0.20    | 2.0 | 20 | 200 | 2,000 | 20,000 | 200,000 | 2,000,000 | 20,000,000 | 200,000,000 |
| J  | 0.22    | 2.2 | 22 | 220 | 2,200 | 22,000 | 220,000 | 2,200,000 | 22,000,000 | 220,000,000 |
| K  | 0.24    | 2.4 | 24 | 240 | 2,400 | 24,000 | 240,000 | 2,400,000 | 24,000,000 | 240,000,000 |
| L  | 0.27    | 2.7 | 27 | 270 | 2,700 | 27,000 | 270,000 | 2,700,000 | 27,000,000 | 270,000,000 |
| M  | 0.30    | 3.0 | 30 | 300 | 3,000 | 30,000 | 300,000 | 3,000,000 | 30,000,000 | 300,000,000 |
| N  | 0.33    | 3.3 | 33 | 330 | 3,300 | 33,000 | 330,000 | 3,300,000 | 33,000,000 | 330,000,000 |
| P  | 0.36    | 3.6 | 36 | 360 | 3,600 | 36,000 | 360,000 | 3,600,000 | 36,000,000 | 360,000,000 |
| Q  | 0.39    | 3.9 | 39 | 390 | 3,900 | 39,000 | 390,000 | 3,900,000 | 39,000,000 | 390,000,000 |
| R  | 0.43    | 4.3 | 43 | 430 | 4,300 | 43,000 | 430,000 | 4,300,000 | 43,000,000 | 430,000,000 |
| S  | 0.47    | 4.7 | 47 | 470 | 4,700 | 47,000 | 470,000 | 4,700,000 | 47,000,000 | 470,000,000 |
| T  | 0.51    | 5.1 | 51 | 510 | 5,100 | 51,000 | 510,000 | 5,100,000 | 51,000,000 | 510,000,000 |
| U  | 0.56    | 5.6 | 56 | 560 | 5,600 | 56,000 | 560,000 | 5,600,000 | 56,000,000 | 560,000,000 |
| V  | 0.62    | 6.2 | 62 | 620 | 6,200 | 62,000 | 620,000 | 6,200,000 | 62,000,000 | 620,000,000 |
| W  | 0.68    | 6.8 | 68 | 680 | 6,800 | 68,000 | 680,000 | 6,800,000 | 68,000,000 | 680,000,000 |
| X  | 0.75    | 7.5 | 75 | 750 | 7,500 | 75,000 | 750,000 | 7,500,000 | 75,000,000 | 750,000,000 |
| Y  | 0.82    | 8.2 | 82 | 820 | 8,200 | 82,000 | 820,000 | 8,200,000 | 82,000,000 | 820,000,000 |
| Z  | 0.91    | 9.1 | 91 | 910 | 9,100 | 91,000 | 910,000 | 9,100,000 | 91,000,000 | 910,000,000 |
| a  | 0.25    | 2.5 | 25 | 250 | 2,500 | 25,000 | 250,000 | 2,500,000 | 25,000,000 | 250,000,000 |
| b  | 0.35    | 3.5 | 35 | 350 | 3,500 | 35,000 | 350,000 | 3,500,000 | 35,000,000 | 350,000,000 |
| d  | 0.40    | 4.0 | 40 | 400 | 4,000 | 40,000 | 400,000 | 4,000,000 | 40,000,000 | 400,000,000 |
| e  | 0.45    | 4.5 | 45 | 450 | 4,500 | 45,000 | 450,000 | 4,500,000 | 45,000,000 | 450,000,000 |
| f  | 0.50    | 5.0 | 50 | 500 | 5,000 | 50,000 | 500,000 | 5,000,000 | 50,000,000 | 500,000,000 |
| m  | 0.60    | 6.0 | 60 | 600 | 6,000 | 60,000 | 600,000 | 6,000,000 | 60,000,000 | 600,000,000 |
| n  | 0.70    | 7.0 | 70 | 700 | 7,000 | 70,000 | 700,000 | 7,000,000 | 70,000,000 | 700,000,000 |
| t  | 0.80    | 8.0 | 80 | 800 | 8,000 | 80,000 | 800,000 | 8,000,000 | 80,000,000 | 800,000,000 |
| y  | 0.90    | 9.0 | 90 | 900 | 9,000 | 90,000 | 900,000 | 9,000,000 | 90,000,000 | 900,000,000 |



## Tape & Reel Packaging Information

KEMET offers multilayer ceramic chip capacitors packaged in 8, 12 and 16 mm tape on 7" and 13" reels in accordance with EIA Standard 481. This packaging system is compatible with all tape-fed automatic pick and place systems. See Table 2 for details on reeling quantities for commercial chips.

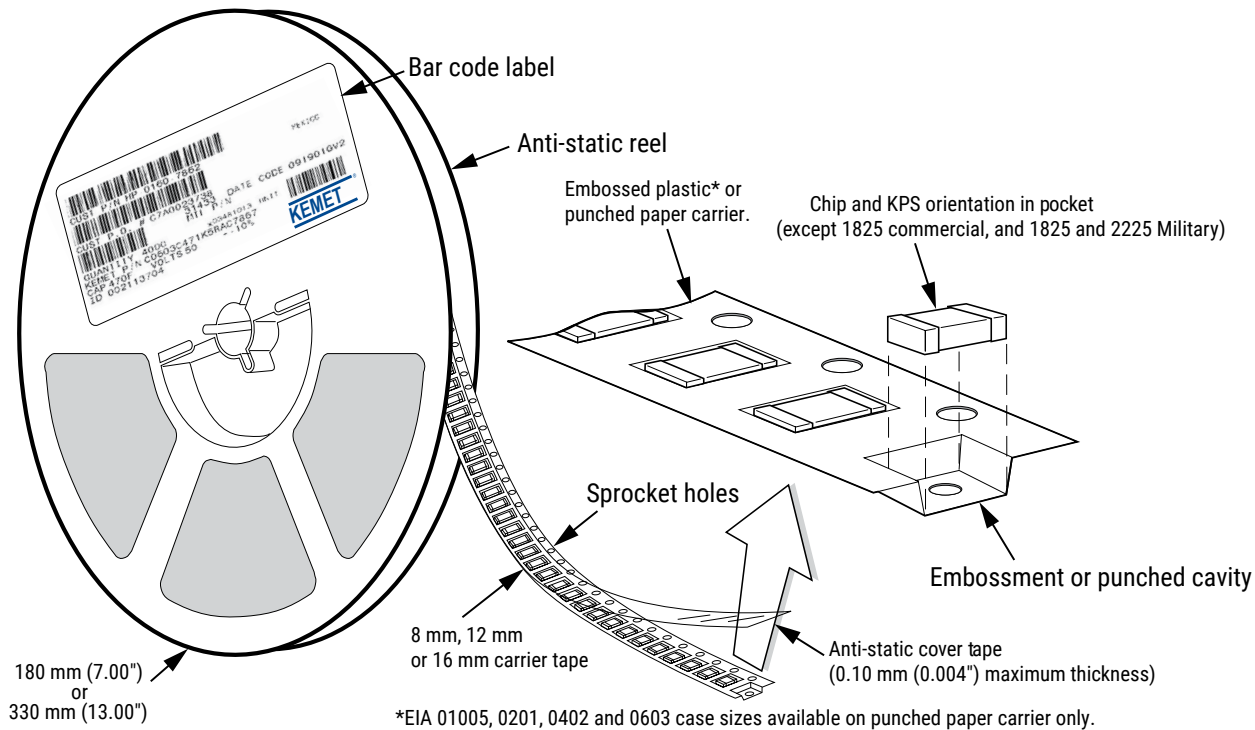

**Table 5 – Carrier Tape Configuration, Embossed Plastic & Punched Paper (mm)**

| EIA Case Size     | Tape Size (W)* | Embossed Plastic         |          | Punched Paper            |          |
|-------------------|----------------|--------------------------|----------|--------------------------|----------|
|                   |                | 7" Reel                  | 13" Reel | 7" Reel                  | 13" Reel |
|                   |                | Pitch (P <sub>1</sub> )* |          | Pitch (P <sub>1</sub> )* |          |
| 01005 – 0402      | 8              |                          |          | 2                        | 2        |
| 0603              | 8              |                          |          | 2/4                      | 2/4      |
| 0805              | 8              | 4                        | 4        | 4                        | 4        |
| 1206 – 1210       | 8              | 4                        | 4        | 4                        | 4        |
| 1805 – 1808       | 12             | 4                        | 4        |                          |          |
| ≥ 1812            | 12             | 8                        | 8        |                          |          |
| KPS 1210          | 12             | 8                        | 8        |                          |          |
| KPS 1812 and 2220 | 16             | 12                       | 12       |                          |          |
| Array 0612        | 8              | 4                        | 4        |                          |          |

### New 2 mm Pitch Reel Options\*

| Packaging Ordering Code (C-Spec) | Packaging Type/Options             |
|----------------------------------|------------------------------------|
| C-3190                           | Automotive grade 7" reel unmarked  |
| C-3191                           | Automotive grade 13" reel unmarked |
| C-7081                           | Commercial grade 7" reel unmarked  |
| C-7082                           | Commercial grade 13" reel unmarked |

\* 2 mm pitch reel only available for 0603 EIA case size.  
 2 mm pitch reel for 0805 EIA case size under development.

### Benefits of Changing from 4 mm to 2 mm Pitching Spacing

- Lower placement costs.
- Double the parts on each reel results in fewer reel changes and increased efficiency.
- Fewer reels result in lower packaging, shipping and storage costs, reducing waste.

\*Refer to Figures 1 and 2 for W and P<sub>1</sub> carrier tape reference locations.

\*Refer to Tables 6 and 7 for tolerance specifications.

**Figure 1 – Embossed (Plastic) Carrier Tape Dimensions**

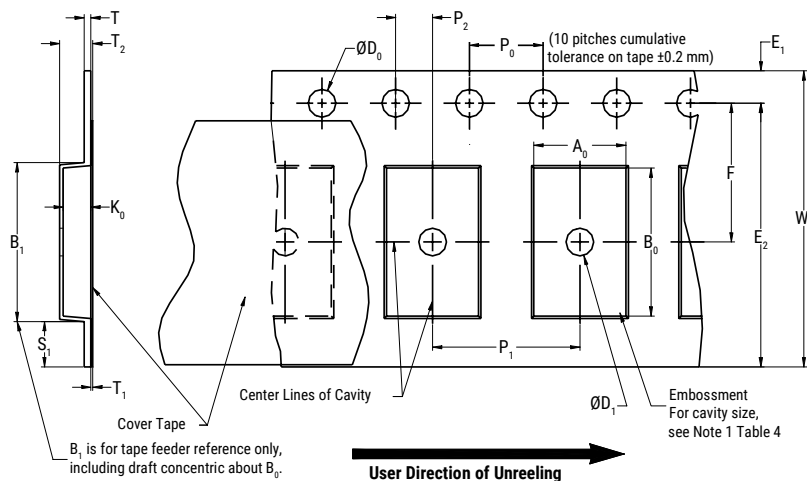

**Table 6 – Embossed (Plastic) Carrier Tape Dimensions**

Metric will govern

| Constant Dimensions – Millimeters (Inches) |                                       |                                  |                              |                             |                              |                           |                                  |  |                           |
|--|---------------------------------------|----------------------------------|------------------------------|-----------------------------|------------------------------|---------------------------|----------------------------------|--|---------------------------|
| Tape Size                                  | D <sub>0</sub>                        | D <sub>1</sub> Minimum<br>Note 1 | E <sub>1</sub>               | P <sub>0</sub>              | P <sub>2</sub>               | R Reference<br>Note 2     | S <sub>1</sub> Minimum<br>Note 3 | T<br>Maximum                                     | T <sub>1</sub><br>Maximum |
| 8 mm                                       | 1.5 +0.10/-0.0<br>(0.059 +0.004/-0.0) | 1.0<br>(0.039)                   | 1.75 ±0.10<br>(0.069 ±0.004) | 4.0 ±0.10<br>(0.157 ±0.004) | 2.0 ±0.05<br>(0.079 ±0.002)  | 25.0<br>(0.984)           | 0.600<br>(0.024)                 | 0.600<br>(0.024)                                 | 0.100<br>(0.004)          |
| 12 mm                                      |                                       | 1.5<br>(0.059)                   |                              |                             |                              |                           |                                  |  |                           |
| 16 mm                                      |                                       |                                  |                              |                             |                              |                           |                                  |  |                           |
| Variable Dimensions – Millimeters (Inches) |                                       |                                  |                              |                             |                              |                           |                                  |  |                           |
| Tape Size                                  | Pitch                                 | B <sub>1</sub> Maximum<br>Note 4 | E <sub>2</sub><br>Minimum    | F                           | P <sub>1</sub>               | T <sub>2</sub><br>Maximum | W<br>Maximum                     | A <sub>0</sub> , B <sub>0</sub> & K <sub>0</sub> |                           |
| 8 mm                                       | Single (4 mm)                         | 4.35<br>(0.171)                  | 6.25<br>(0.246)              | 3.5 ±0.05<br>(0.138 ±0.002) | 4.0 ±0.10<br>(0.157 ±0.004)  | 2.5<br>(0.098)            | 8.3<br>(0.327)                   | Note 5   |                           |
| 12 mm                                      | Single (4 mm)<br>and double (8 mm)    | 8.2<br>(0.323)                   | 10.25<br>(0.404)             | 5.5 ±0.05<br>(0.217 ±0.002) | 8.0 ±0.10<br>(0.315 ±0.004)  | 4.6<br>(0.181)            | 12.3<br>(0.484)                  |  |                           |
| 16 mm                                      | Triple (12 mm)                        | 12.1<br>(0.476)                  | 14.25<br>(0.561)             | 7.5 ±0.05<br>(0.138 ±0.002) | 12.0 ±0.10<br>(0.157 ±0.004) | 4.6<br>(0.181)            | 16.3<br>(0.642)                  |  |                           |

1. The embossment hole location shall be measured from the sprocket hole controlling the location of the embossment. Dimensions of the embossment location and the hole location shall be applied independently of each other.
2. The tape with or without components shall pass around R without damage (see Figure 6.)
3. If S<sub>1</sub> < 1.0 mm, there may not be enough area for a cover tape to be properly applied (see EIA Standard 481, paragraph 4.3, section b.)
4. B<sub>1</sub> dimension is a reference dimension for tape feeder clearance only.
5. The cavity defined by A<sub>0</sub>, B<sub>0</sub> and K<sub>0</sub> shall surround the component with sufficient clearance that:
  - (a) the component does not protrude above the top surface of the carrier tape.
  - (b) the component can be removed from the cavity in a vertical direction without mechanical restriction, after the top cover tape has been removed.
  - (c) rotation of the component is limited to 20° maximum for 8 and 12 mm tapes and 10° maximum for 16 mm tapes (see Figure 3.)
  - (d) lateral movement of the component is restricted to 0.5 mm maximum for 8 and 12 mm wide tape and to 1.0 mm maximum for 16 mm tape (see Figure 4.)
  - (e) for KPS product, A<sub>0</sub> and B<sub>0</sub> are measured on a plane 0.3 mm above the bottom of the pocket.
  - (f) see addendum in EIA Standard 481 for standards relating to more precise taping requirements.

**Figure 2 – Punched (Paper) Carrier Tape Dimensions**

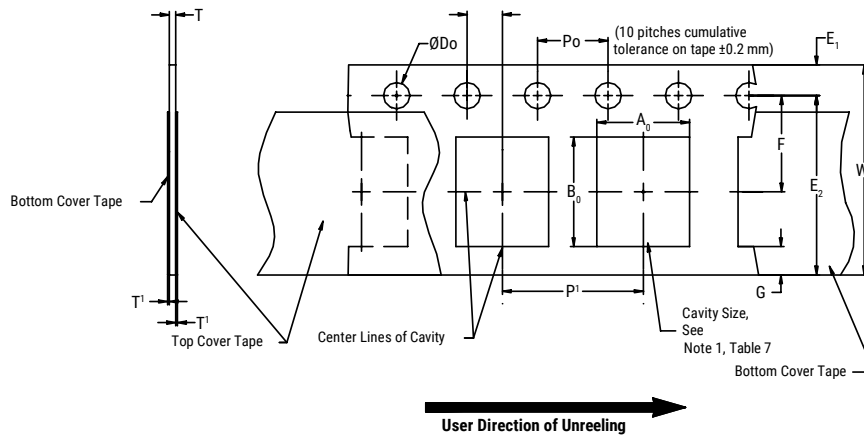

**Table 7 – Punched (Paper) Carrier Tape Dimensions**

Metric will govern

| Constant Dimensions – Millimeters (Inches) |                                       |                              |                             |                             |                            |                 |                    |
|--|---------------------------------------|------------------------------|-----------------------------|-----------------------------|----------------------------|-----------------|--------------------|
| Tape Size                                  | $D_0$                                 | $E_1$                        | $P_0$                       | $P_2$                       | $T_1$ Maximum              | G Minimum       | R Reference Note 2 |
| 8 mm                                       | 1.5 +0.10 -0.0<br>(0.059 +0.004 -0.0) | 1.75 ±0.10<br>(0.069 ±0.004) | 4.0 ±0.10<br>(0.157 ±0.004) | 2.0 ±0.05<br>(0.079 ±0.002) | 0.10<br>(0.004)<br>maximum | 0.75<br>(0.030) | 25<br>(0.984)      |
| Variable Dimensions – Millimeters (Inches) |                                       |                              |                             |                             |                            |                 |                    |
| Tape Size                                  | Pitch                                 | E2 Minimum                   | F                           | $P_1$                       | T Maximum                  | W Maximum       | $A_0 B_0$          |
| 8 mm                                       | Half (2 mm)                           | 6.25<br>(0.246)              | 3.5 ±0.05<br>(0.138 ±0.002) | 2.0 ±0.05<br>(0.079 ±0.002) | 1.1<br>(0.098)             | 8.3<br>(0.327)  | Note 1             |
| 8 mm                                       | Single (4 mm)                         |                              |                             | 4.0 ±0.10<br>(0.157 ±0.004) |                            |                 |                    |

- The cavity defined by  $A_0$ ,  $B_0$  and  $T$  shall surround the component with sufficient clearance that:
  - the component does not protrude beyond either surface of the carrier tape.
  - the component can be removed from the cavity in a vertical direction without mechanical restriction, after the top cover tape has been removed.
  - rotation of the component is limited to 20° maximum (see Figure 3.)
  - lateral movement of the component is restricted to 0.5 mm maximum (see Figure 4.)
  - see addendum in EIA Standard 481 for standards relating to more precise taping requirements.
- The tape with or without components shall pass around R without damage (see Figure 6.)

## Packaging Information Performance Notes

- 1. Cover Tape Break Force:** 1.0 kg minimum.
- 2. Cover Tape Peel Strength:** The total peel strength of the cover tape from the carrier tape shall be:

| Tape Width   | Peel Strength                    |
|--------------|----------------------------------|
| 8 mm         | 0.1 to 1.0 newton (10 to 100 gf) |
| 12 and 16 mm | 0.1 to 1.3 newton (10 to 130 gf) |

The direction of the pull shall be opposite the direction of the carrier tape travel. The pull angle of the carrier tape shall be 165° to 180° from the plane of the carrier tape. During peeling, the carrier and/or cover tape shall be pulled at a velocity of 300 ±10 mm/minute.

- 3. Labeling:** Bar code labeling (standard or custom) shall be on the side of the reel opposite the sprocket holes. Refer to EIA Standards 556 and 624.

### Figure 3 – Maximum Component Rotation



### Figure 4 – Maximum Lateral Movement



### Figure 5 – Bending Radius

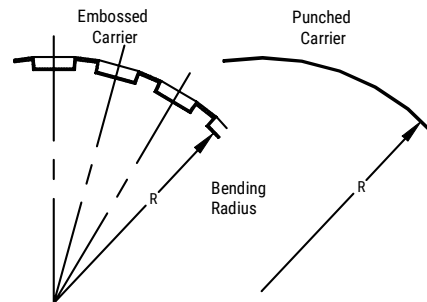

**Figure 6 – Reel Dimensions**



Note: Drive spokes optional; if used, dimensions B and D shall apply.

**Table 8 – Reel Dimensions**

Metric will govern

| Constant Dimensions – Millimeters (Inches) |   |                                       |  |   |
|--|---|---------------------------------------|--|---|
| Tape Size                                  | A   | B Minimum                             | C                                      | D Minimum   |
| 8 mm                                       | 178 ±0.20<br>(7.008 ±0.008)<br>or<br>330 ±0.20<br>(13.000 ±0.008) | 1.5<br>(0.059)                        | 13.0 +0.5/-0.2<br>(0.521 +0.02/-0.008) | 20.2<br>(0.795)                                   |
| 12 mm                                      |   |                                       |  |   |
| 16 mm                                      |   |                                       |  |   |
| Variable Dimensions – Millimeters (Inches) |   |                                       |  |   |
| Tape Size                                  | N Minimum   | W <sub>1</sub>                        | W <sub>2</sub> Maximum                 | W <sub>3</sub>                                    |
| 8 mm                                       | 50<br>(1.969)   | 8.4 +1.5/-0.0<br>(0.331 +0.059/-0.0)  | 14.4<br>(0.567)                        | Shall accommodate tape width without interference |
| 12 mm                                      |   | 12.4 +2.0/-0.0<br>(0.488 +0.078/-0.0) | 18.4<br>(0.724)                        |   |
| 16 mm                                      |   | 16.4 +2.0/-0.0<br>(0.646 +0.078/-0.0) | 22.4<br>(0.882)                        |   |

**Figure 7 – Tape Leader & Trailer Dimensions**

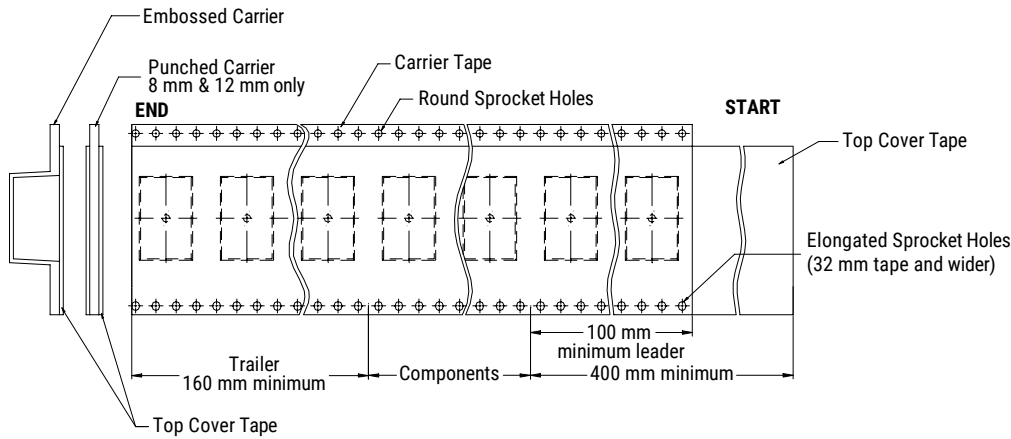

**Figure 8 – Maximum Camber**

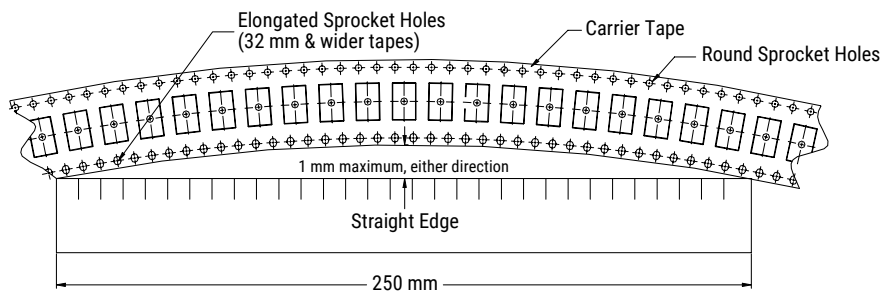

## KEMET Electronics Corporation Sales Offices

For a complete list of our global sales offices, please visit [www.kemet.com/sales](http://www.kemet.com/sales).

---

### Disclaimer

All product specifications, statements, information and data (collectively, the "Information") in this datasheet are subject to change. The customer is responsible for checking and verifying the extent to which the Information contained in this publication is applicable to an order at the time the order is placed. All Information given herein is believed to be accurate and reliable, but it is presented without guarantee, warranty, or responsibility of any kind, expressed or implied.

Statements of suitability for certain applications are based on KEMET Electronics Corporation's ("KEMET") knowledge of typical operating conditions for such applications, but are not intended to constitute – and KEMET specifically disclaims – any warranty concerning suitability for a specific customer application or use. The Information is intended for use only by customers who have the requisite experience and capability to determine the correct products for their application. Any technical advice inferred from this Information or otherwise provided by KEMET with reference to the use of KEMET's products is given gratis, and KEMET assumes no obligation or liability for the advice given or results obtained.

Although KEMET designs and manufactures its products to the most stringent quality and safety standards, given the current state of the art, isolated component failures may still occur. Accordingly, customer applications which require a high degree of reliability or safety should employ suitable designs or other safeguards (such as installation of protective circuitry or redundancies) in order to ensure that the failure of an electrical component does not result in a risk of personal injury or property damage.

Although all product-related warnings, cautions and notes must be observed, the customer should not assume that all safety measures are indicated or that other measures may not be required.

*KEMET is a registered trademark of KEMET Electronics Corporation.*