

INTERCONNECTS

SERIES 800 & 801 • .100" GRID (.030" DIA. PINS), STRAIGHT & RIGHT ANGLE HEADERS AND SOCKETS • SINGLE ROW STRIPS

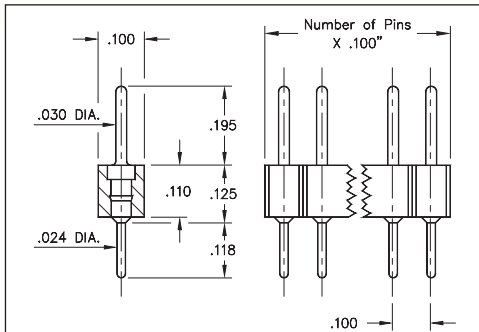

FIG. 1

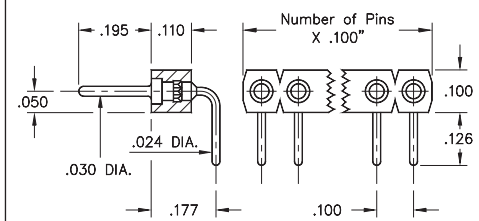

FIG. 2

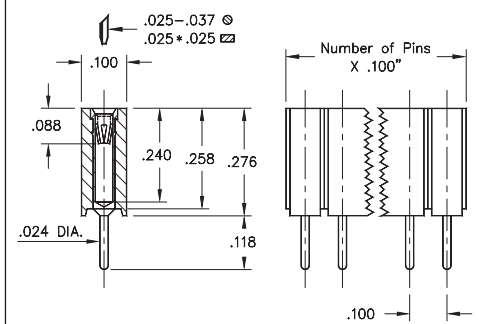

FIG. 3

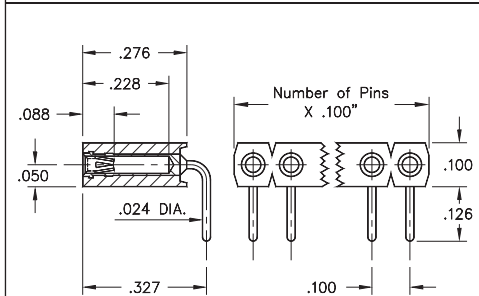
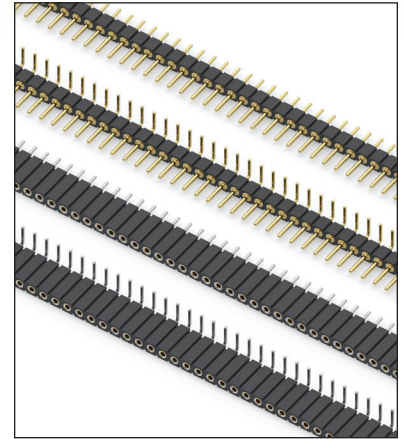

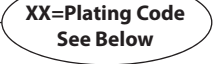







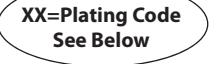
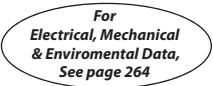





FIG. 4

- Pin interconnects available with straight MM #7007 or right angle MM #5005 solder tails. See page 215 for details
- Sockets are available with straight MM #1304 or right angle MM #1305 soldertails. See pages 177 and 179 for details
- MM #1304 and MM #1305 receptacles use Hi-Rel, 6-finger BeCu #47 contact rated at 4.5 amps. Receptacles accept .030" diameter and .025" square pins. See page 256 for details
- Insulators are high temperature thermoplastic, suitable for all soldering operations



ORDERING INFORMATION

| FIG. 1 | Series 800...10-001 | | Straight Pin Header | |
|--|--|--------------|--|-------|
| | | 800-XX-0 | -10-001000 | 01-64 |
| Specify number of pins | | | | |
| FIG. 2 | Series 800...20-001 | | Right Angle Pin Header | |
| | | 800-XX-0 | -20-001000 | 02-64 |
| Specify number of pins | | | | |
|    | | | | |
| SPECIFY PLATING CODE XX= | | | | |
| Pin Plating  | | | | |
| | 10  | 90 | 40  | |
| | 10 μ" Au | 200 μ" Sn/Pb | 200 μ" Sn | |

| FIG. 3 | Series 801...10-001 | | Straight Socket | | | |
|--|---------------------|--------------|--------------------|--|--|--|
| | | 801-XX-0 | -10-001000 | 01-50 | | |
| Specify number of pins | | | | | | |
| FIG. 4 | Series 801...20-001 | | Right Angle Socket | | | |
| | | 801-XX-0 | -20-001000 | 01-50 | | |
| Specify number of pins | | | | | | |
|    | | | | | | |
| SPECIFY PLATING CODE XX= | | | | | | |
| Sleeve (Pin)  | | | | | | |
| Contact (Clip)  | | | | | | |
| | 91 | 93 | 99 | 41  | 43  | 44  |
| | 200 μ" Sn/Pb | 200 μ" Sn/Pb | 200 μ" Sn/Pb | 200 μ" Sn | 200 μ" Sn | 200 μ" Sn |
| | 10 μ" Au | 30 μ" Au | 100 μ" Sn/Pb | 10 μ" Au | 30 μ" Au | 100 μ" Sn |
| | | | | | | Au Flash |

★ 44 Plating Non-Standard



Mouser Electronics

Authorized Distributor

Click to View Pricing, Inventory, Delivery & Lifecycle Information:

Mill-Max:

[801-99-050-20-001000](#) [801-99-050-10-001000](#) [801-99-036-10-001000](#) [801-93-036-10-001000](#) [800-90-064-20-001000](#) [800-90-064-10-001000](#) [800-90-020-20-001000](#) [800-90-020-10-001000](#) [800-10-020-20-001000](#) [800-10-020-10-001000](#) [800-10-064-20-001000](#) [800-90-010-20-001000](#) [800-10-002-10-001000](#) [801-93-050-10-001000](#) [801-93-003-10-001000](#) [801-93-001-10-001000](#) [801-93-014-10-001000](#) [800-10-012-10-001000](#) [800-10-016-10-001000](#) [800-10-010-10-001000](#) [801-93-011-20-001000](#) [801-93-010-10-001000](#) [801-93-011-10-001000](#) [801-93-004-20-001000](#) [801-93-002-10-001000](#) [801-93-050-20-001000](#) [801-99-036-20-001000](#) [801-93-020-10-001000](#) [801-43-036-20-001000](#) [801-43-036-10-001000](#) [800-40-064-20-001000](#) [800-40-064-10-001000](#) [800-40-020-20-001000](#) [800-40-020-10-001000](#) [801-41-020-10-001000](#) [800-10-004-20-001000](#) [800-10-064-10-001000](#) [800-10-008-10-001000](#) [800-10-002-20-001000](#) [801-93-036-20-001000](#) [801-43-050-20-001000](#) [801-43-050-10-001000](#) [800-40-015-20-001000](#) [800-90-040-10-001000](#) [800-10-014-10-001000](#) [801-93-002-20-001000](#)