

T H E R M O M E T R I C S
A C O M M I T M E N T T O E X C E L L E N C E

ZTP-115M

Thermopile IR Module

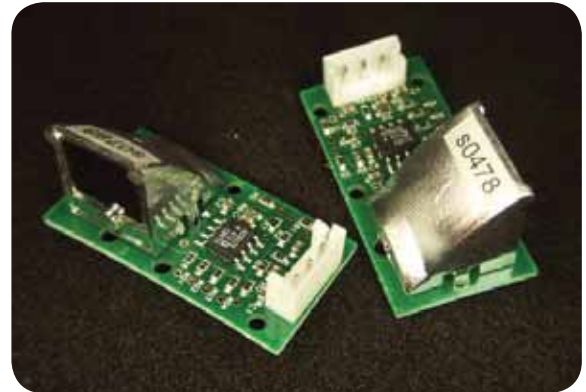

The ZTP-115M is a single IR module used for non-contact surface temperature measuring. It consists of a thermopile, IR sensor, signal conditioning and voltage output.

Applications

- Occupancy detection
- HVAC
- Appliance
- Microwave oven

Features

- Non-contact measurement
- Wider surface area measurement
- Small-size sensor package
- Included ambient temperature - (thermistor) sensor for compensation
- High sensitivity
- Fast response time
- Low cost
- Analog output

Amphenol
Advanced Sensors

Specifications

Supply Voltage

Single Supply (+5V)

Supply Current

Typical 2.7 mA

Response Time

0.3 ~ 0.6 second

Range of Measuring Temperature

-40°C ~ 145°C

Operating Temperature

-20°C ~ 100°C

Storage Temperature

-20°C ~ 120°C

Thermopile Sensor

ZTP-115

Field of View

- Horizontal Normalized Output (above 50%) : $\pm 5.5^\circ$
- Vertical Normalized Output (above 50%) : $+6^\circ / -3.5^\circ$

*Condition : Distance of IR Point Source to Reflector : 170 mm

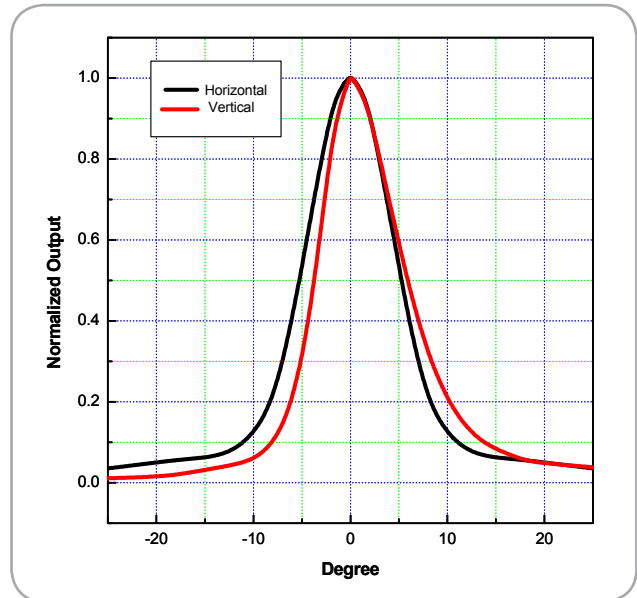

- Spot Size of Normalized Output (above 10%)

Sensitivity

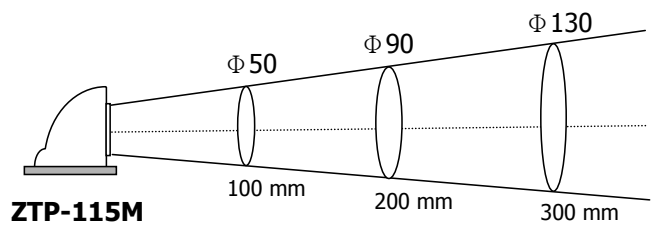
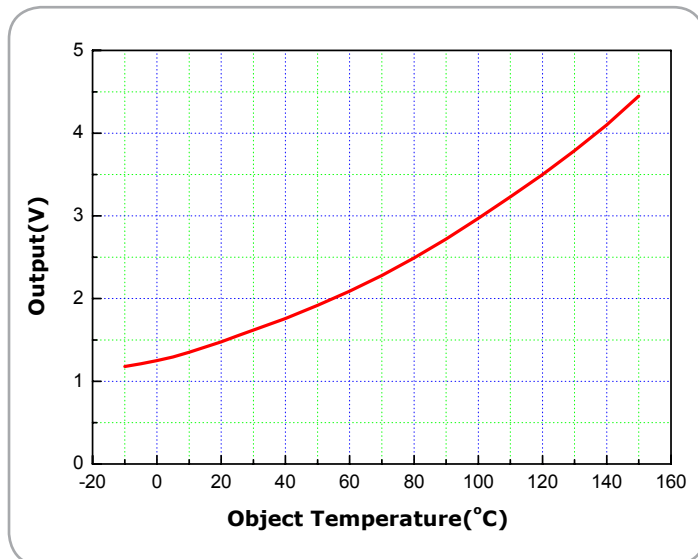

Temperature Accuracy (Typical)

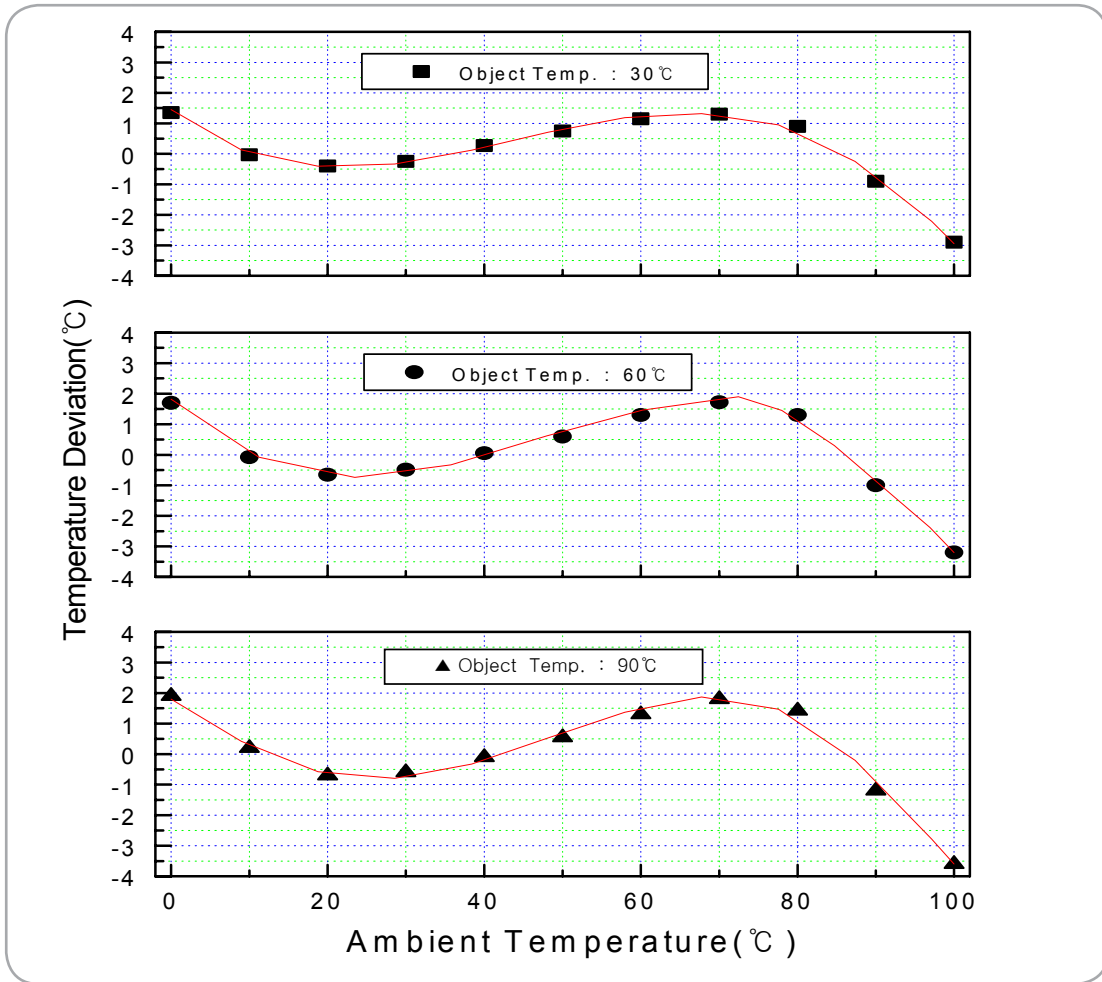

Outline of Sensor Packaging and Pin Arrangement

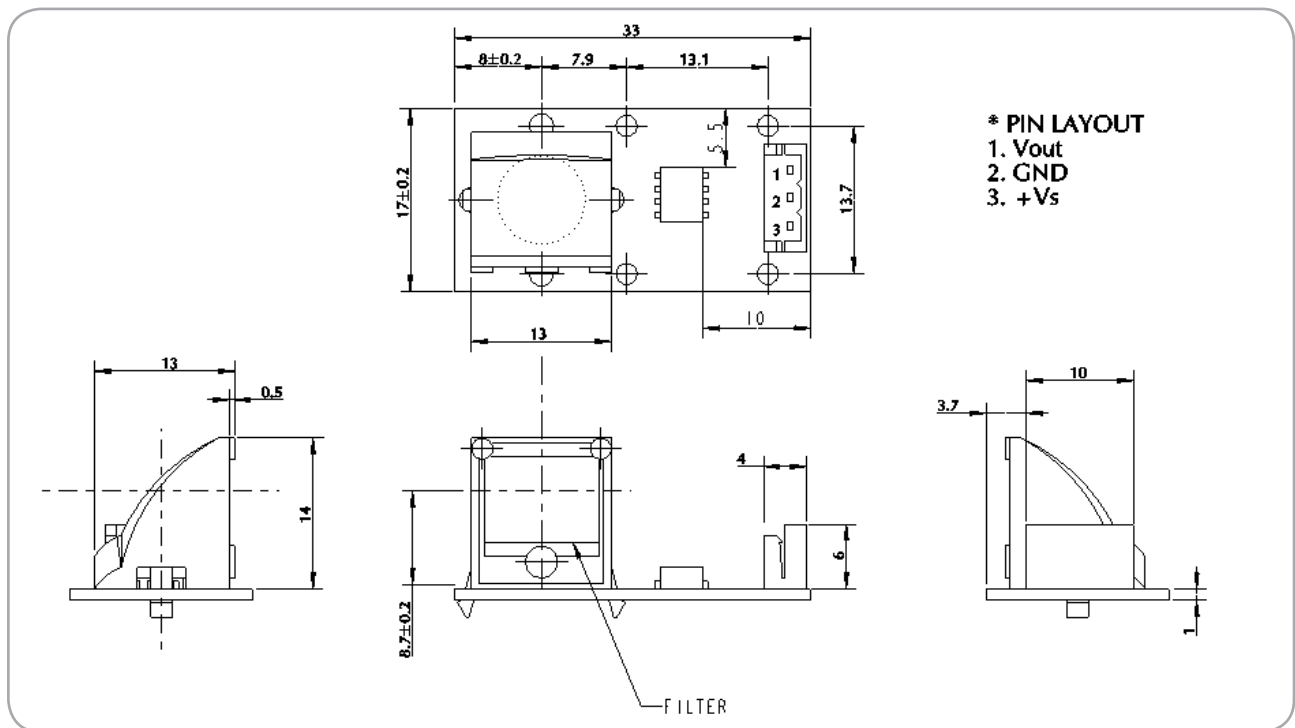

Module Circuit

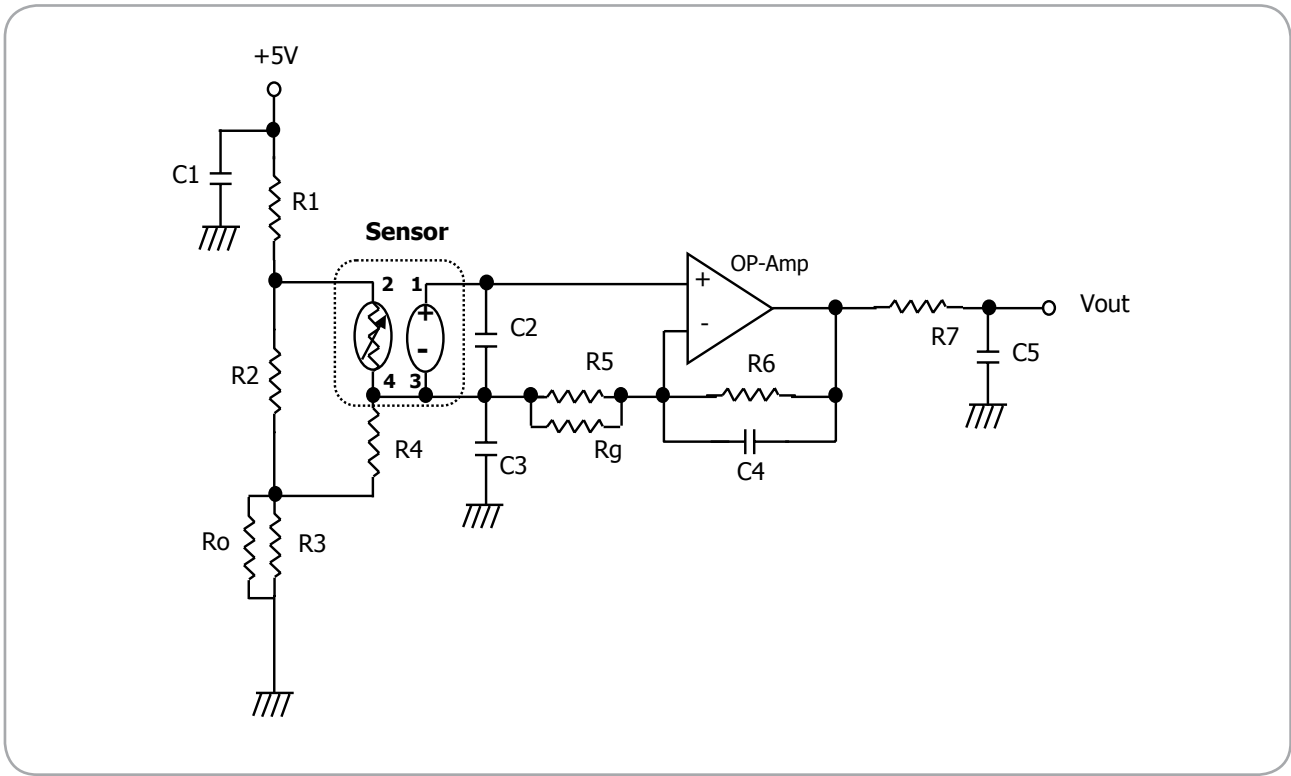

Amphenol
Advanced Sensors

www.amphenol-sensors.com

© 2014 Amphenol Corporation. All Rights Reserved. Specifications are subject to change without notice. Other company names and product names used in this document are the registered trademarks or trademarks of their respective owners.

AAS-920-550A-03/2014

Mouser Electronics

Authorized Distributor

Click to View Pricing, Inventory, Delivery & Lifecycle Information:

[Amphenol:](#)

[ZTP-115M](#)