

SN65MLVD20xx Multipoint-LVDS Line Driver and Receiver

1 Features

- Low-Voltage Differential 30-Ω to 55-Ω Line Drivers and Receivers for Signaling Rates⁽¹⁾ up to 100 Mbps, Clock Frequencies up to 50 MHz
- Type-1 Receivers Incorporate 25 mV of Hysteresis (SN65MLVD200A, SN65MLVD202A)
- Type-2 Receivers Provide an Offset (100 mV) Threshold to Detect Open-Circuit and Idle-Bus Conditions (SN65MLVD204A, SN65MLVD205A)
- Meets or Exceeds the M-LVDS Standard TIA/EIA-899 for Multipoint Data Interchange
- Controlled Driver Output Voltage Transition Times for Improved Signal Quality
- -1 V to 3.4 V of Common-Mode Voltage Range Allows Data Transfer With 2 V of Ground Noise
- Bus Pins High Impedance When Disabled or $V_{CC} \leq 1.5$ V
- 200-Mbps Devices Available (SN65MLVD201, SN65MLVD203, SN65MLVD206, SN65MLVD207)
- Bus Pin ESD Protection Exceeds 8 kV
- Packages Available:
 - 8-Pin SOIC
SN65MLVD200A, SN65MLVD204A
 - 14-Pin SOIC
SN65MLVD202A, SN65MLVD205A
- Improved Alternatives to the SN65MLVD200, SN65MLVD202A, SN65MLVD204A, and SN65MLVD205A Devices

⁽¹⁾ The signaling rate of a line, is the number of voltage transitions that are made per second expressed in the units bps (bits per second).

2 Applications

- Low-Power, High-Speed, Short-Reach Alternative to TIA/EIA-485
- Backplane or Cabled Multipoint Data and Clock Transmission
- Cellular Base Stations
- Central Office Switches
- Network Switches and Routers

3 Description

The SN65MLVD20xx devices are multipoint low-voltage differential (M-LVDS) line drivers and receivers that are optimized to operate at signaling rates up to 100 Mbps. All parts comply with the multipoint low-voltage differential signaling (M-LVDS) standard TIA/EIA-899.

The SN65MLVD20xx devices have enhancements over their predecessors. Improved features include controlled slew rate on the driver output to help minimize reflections from unterminated stubs, which results in better signal integrity. Additionally, 8-kV ESD protection on the bus pins for more robustness. The same footprint definition was maintained making for an easy drop-in replacement for a system performance upgrade.

The devices are characterized for operation from -40°C to 85°C.

Device Information⁽¹⁾

PART NUMBER	PACKAGE	BODY SIZE (NOM)
SN65MLVD200A SN65MLVD204A	SOIC (8)	4.90 mm × 3.91 mm
SN65MLVD202A SN65MLVD205A	SOIC (14)	8.65 mm × 3.91 mm

⁽¹⁾ For all available packages, see the orderable addendum at the end of the data sheet.

Logic Diagrams (Positive Logic)

SN65MLVD200A, SN65MLVD204A

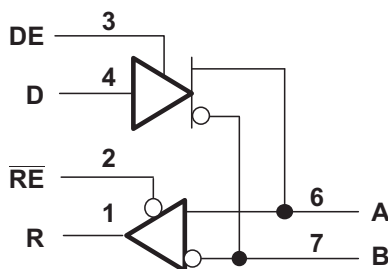

SN65MLVD202A, SN65MLVD205A

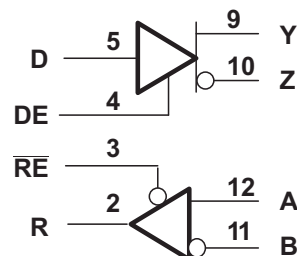

Table of Contents

1 Features	1	9.1 Overview	16
2 Applications	1	9.2 Functional Block Diagram	16
3 Description	1	9.3 Feature Description	16
4 Revision History	2	9.4 Device Functional Modes	17
5 Device Comparison Table	3	10 Application and Implementation	19
6 Pin Configuration and Functions	3	10.1 Application Information	19
7 Specifications	4	10.2 Typical Application	19
7.1 Absolute Maximum Ratings	4	11 Power Supply Recommendations	23
7.2 ESD Ratings	4	12 Layout	23
7.3 Recommended Operating Conditions	4	12.1 Layout Guidelines	23
7.4 Thermal Information	4	12.2 Layout Example	27
7.5 Electrical Characteristics	5	13 Device and Documentation Support	28
7.6 Electrical Characteristics – Driver	5	13.1 Documentation Support	28
7.7 Electrical Characteristics – Receiver	6	13.2 Related Links	28
7.8 Electrical Characteristics – BUS Input and Output ...	6	13.3 Community Resources	29
7.9 Switching Characteristics – Driver	7	13.4 Trademarks	29
7.10 Switching Characteristics – Receiver	7	13.5 Electrostatic Discharge Caution	29
7.11 Typical Characteristics	8	13.6 Glossary	29
8 Parameter Measurement Information	10	14 Mechanical, Packaging, and Orderable Information	29
9 Detailed Description	16		

4 Revision History

Changes from Revision C (September 2015) to Revision D	Page
• Deleted Features list item "Meets ±8-kV IEC 61000-4-2, Contact Discharge"	1

Changes from Revision B (June 2015) to Revision C	Page
• Deleted row "Open Circuit" from Table 3 and Table 4 as redundant	17
• Changed from " $V_{ID} \geq 50 \text{ mV}$ " to " $V_{ID} \geq 150 \text{ mV}$ " in Table 4	17
• Changed from " $-50 \text{ mV} < V_{ID} < 150 \text{ mV}$ " to " $50 \text{ mV} < V_{ID} < 150 \text{ mV}$ " in Table 4	17

Changes from Revision A (December 2003) to Revision B	Page
• <i>Pin Configuration and Functions</i> section, <i>ESD Ratings</i> table, <i>Feature Description</i> section, <i>Device Functional Modes</i> , <i>Application and Implementation</i> section, <i>Power Supply Recommendations</i> section, <i>Layout</i> section, <i>Device and Documentation Support</i> section, and <i>Mechanical, Packaging, and Orderable Information</i> section	1
• Removed SN65MLVD204B from the data sheet	1
• Changed <i>Ordering Information</i> to <i>Device Comparison Table</i>	3
• Deleted $ V_{ID} $ MIN value in <i>Recommended Operating Conditions</i>	4
• Changed <i>Multipoint Configuration</i> image	19

Changes from Original (December 2003) to Revision A	Page
• Deleted duplicate Note from Figure 23	14

5 Device Comparison Table

PART NUMBER	FOOTPRINT	RECEIVER TYPE
SN65MLVD200AD	SN75176	Type 1
SM65MLVD202AD	SN75ALS180	Type 1
SN65MLVD204AD	SN75176	Type 2
SM65MLVD205AD	SN75ALS180	Type 2

6 Pin Configuration and Functions

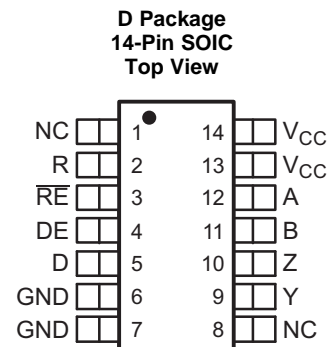
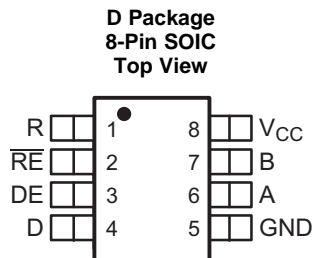

Pin Functions

NAME	PIN		TYPE	DESCRIPTION
	SOIC-8	SOIC-14		
A	6	12	I/O	Differential I/O
B	7	11	I/O	Differential I/O
D	4	5	I	Driver input
DE	3	4	I	Driver enable pin: High = Enable, Low = Disable
GND	5	6, 7	Power	Supply ground
NC	—	1, 8	NC	No internal connection
R	1	2	O	Receiver output
\overline{RE}	2	3	I	Receiver enable pin: High = Disable, Low = Enable
V _{CC}	8	13, 14	Power	Power supply, 3.3 V
Y	—	9	I/O	Differential I/O
Z	—	10	I/O	Differential I/O

7 Specifications

7.1 Absolute Maximum Ratings

over operating free-air temperature range unless otherwise noted⁽¹⁾

		MIN	MAX	UNIT
Supply voltage ⁽²⁾ , V_{CC}		-0.5	4	V
Input voltage	D, DE, \overline{RE}	-0.5	4	V
	A, B (SN65MLVD200A and SN65MLVD204A)	-1.8	4	V
	A, B (SN65MLVD202A, SN65MLVD205A)	-4	6	V
Output voltage range	R	-0.3	4	V
	Y, Z, A, or B	-1.8	4	V
Continuous power dissipation		See Thermal Information		
Storage temperature, T_{stg}		-65	150	°C

- (1) Stresses beyond those listed under *Absolute Maximum Ratings* may cause permanent damage to the device. These are stress ratings only, and functional operation of the device at these or any other conditions beyond those indicated under *Recommended Operating Conditions* is not implied. Exposure to absolute-maximum-rated conditions for extended periods may affect device reliability.
- (2) All voltage values, except differential I/O bus voltages, are with respect to network ground terminal.

7.2 ESD Ratings

			VALUE	UNIT	
$V_{(ESD)}$	Electrostatic discharge	Human body model (HBM), per ANSI/ESDA/JEDEC JS-001, all pins ⁽¹⁾	All pins except A, B, Y, and Z	±4000	V
			A, B, Y, and Z	±8000	
		Charged device model (CDM), per JEDEC specification JESD22-C101, all pins ⁽²⁾	All pins	±1500	

- (1) JEDEC document JEP155 states that 500-V HBM allows safe manufacturing with a standard ESD control process.
- (2) JEDEC document JEP157 states that 250-V CDM allows safe manufacturing with a standard ESD control process.

7.3 Recommended Operating Conditions

		MIN	NOM	MAX	UNIT
V_{CC}	Supply voltage	3	3.3	3.6	V
V_{IH}	High-level input voltage	2		V_{CC}	V
V_{IL}	Low-level input voltage	GND		0.8	V
	Voltage at any bus terminal V_A , V_B , V_Y or V_Z	-1.4		3.8	V
$ V_{ID} $	Magnitude of differential input voltage			V_{CC}	V
R_L	Differential load resistance	30	50		Ω
$1/t_{UI}$	Signaling rate			100	Mbps
T_A	Operating free-air temperature	-40		85	°C

7.4 Thermal Information

THERMAL METRIC ⁽¹⁾		SN65MLVD200A, SN65MLVD204A	SN65MLVD202A, SN65MLVD205A	UNIT
		D (SOIC)	D (SOIC)	
		8 PINS	14 PINS	
$R_{\theta JA}$	Junction-to-ambient thermal resistance	103.9	78.9	°C/W
$R_{\theta JC(top)}$	Junction-to-case (top) thermal resistance	50.6	39	°C/W
$R_{\theta JB}$	Junction-to-board thermal resistance	44.5	33.3	°C/W
ψ_{JT}	Junction-to-top characterization parameter	8.1	7.2	°C/W
ψ_{JB}	Junction-to-board characterization parameter	43.9	33	°C/W

- (1) For more information about traditional and new thermal metrics, see the *Semiconductor and IC Package Thermal Metrics* application report (SPRA953).

7.5 Electrical Characteristics

over recommended operating conditions unless otherwise noted

PARAMETER		TEST CONDITIONS	MIN	TYP ⁽¹⁾	MAX	UNIT
I _{CC}	Driver only	\overline{RE} and DE at V _{CC} , R _L = 50 Ω, All others open		13	22	mA
	Both disabled	\overline{RE} at V _{CC} , DE at 0 V, R _L = No Load, All others open		1	4	
	Both enabled	\overline{RE} at 0 V, DE at V _{CC} , R _L = 50 Ω, All others open		16	24	
	Receiver only	\overline{RE} at 0 V, DE at 0 V, All others open		4	13	
P _D	Device power dissipation	R _L = 50 Ω, Input to D is a 50-MHz 50% duty cycle square wave, DE = high, \overline{RE} = low, T _A = 85°C			94	mW

(1) All typical values are at 25°C and with a 3.3-V supply voltage.

7.6 Electrical Characteristics – Driver

over recommended operating conditions unless otherwise noted

PARAMETER		TEST CONDITIONS	MIN ⁽¹⁾	TYP ⁽²⁾	MAX	UNIT
V _{AB} or V _{YZ}	Differential output voltage magnitude	See Figure 14	480		650	mV
Δ V _{AB} or Δ V _{YZ}	Change in differential output voltage magnitude between logic states		–50		50	mV
V _{OS(SS)}	Steady-state common-mode output voltage	See Figure 15	0.8		1.2	V
ΔV _{OS(SS)}	Change in steady-state common-mode output voltage between logic states		–50		50	mV
V _{OS(PP)}	Peak-to-peak common-mode output voltage				150	mV
V _{Y(OC)} or V _{A(OC)}	Maximum steady-state open-circuit output voltage	See Figure 19	0		2.4	V
V _{Z(OC)} or V _{B(OC)}	Maximum steady-state open-circuit output voltage		0		2.4	V
V _{P(H)}	Voltage overshoot, low-to-high level output	See Figure 17			1.2 V _{SS}	V
V _{P(L)}	Voltage overshoot, high-to-low level output		–0.2 V _{SS}			V
I _{IH}	High-level input current (D, DE)	V _{IH} = 2 V to V _{CC}	0		10	μA
I _{IL}	Low-level input current (D, DE)	V _{IL} = GND to 0.8 V	0		10	μA
I _{OS}	Differential short-circuit output current magnitude	See Figure 4			24	mA
I _{OZ}	High-impedance state output current (driver only)	–1.4 V ≤ (V _Y or V _Z) ≤ 3.8 V, Other output = 1.2 V	–15		10	μA
I _{O(OFF)}	Power-off output current	–1.4 V ≤ (V _Y or V _Z) ≤ 3.8 V, Other output = 1.2 V, 0 V ≤ V _{CC} ≤ 1.5 V	–10		10	μA
C _Y or C _Z	Output capacitance	V _I = 0.4 sin(30E6πt) + 0.5 V, ⁽³⁾ Other input at 1.2 V, driver disabled		3		pF
C _{YZ}	Differential output capacitance	V _{AB} = 0.4 sin(30E6πt) V, ⁽³⁾ Driver disabled			2.5	pF
C _{Y/Z}	Output capacitance balance, (C _Y /C _Z)		0.99		1.01	

(1) The algebraic convention in which the least positive (most negative) limit is designated as minimum is used in this data sheet.

(2) All typical values are at 25°C and with a 3.3-V supply voltage.

(3) HP4194A impedance analyzer (or equivalent)

7.7 Electrical Characteristics – Receiver

over recommended operating conditions unless otherwise noted

PARAMETER		TEST CONDITIONS	MIN	TYP ⁽¹⁾	MAX	UNIT
V _{IT+}	Positive-going differential input voltage threshold	Type 1			50	mV
		Type 2			150	
V _{IT-}	Negative-going differential input voltage threshold	Type 1	See Figure 9, Table 1, and Table 2		-50	mV
		Type 2			50	
V _{HYS}	Differential input voltage hysteresis, (V _{IT+} – V _{IT-})	Type 1			25	mV
		Type 2			0	
V _{OH}	High-level output voltage (R)	I _{OH} = -8 mA	2.4			V
V _{OL}	Low-level output voltage (R)	I _{OL} = 8 mA			0.4	V
I _{IH}	High-level input current (\overline{RE})	V _{IH} = 2 V to V _{CC}	-10		0	μA
I _{IL}	Low-level input current (\overline{RE})	V _{IL} = GND to 0.8 V	-10		0	μA
I _{OZ}	High-impedance output current (R)	V _O = 0 V or 3.6 V	-10		15	μA
C _A or C _B	Input capacitance	V _I = 0.4 sin(30E6πt) + 0.5 V ⁽²⁾ , Other input at 1.2 V		3		pF
C _{AB}	Differential input capacitance	V _{AB} = 0.4 sin(30E6πt) V ⁽²⁾			2.5	pF
C _{A/B}	Input capacitance balance, (C _A /C _B)		0.99		1.01	

(1) All typical values are at 25°C and with a 3.3-V supply voltage.

(2) HP4194A impedance analyzer (or equivalent)

7.8 Electrical Characteristics – BUS Input and Output

over recommended operating conditions unless otherwise noted

PARAMETER		TEST CONDITIONS	MIN	TYP ⁽¹⁾	MAX	UNIT
I _A	Receiver or transceiver with driver disabled input current	V _A = 3.8 V, V _B = 1.2 V,	0		32	μA
		V _A = 0 V or 2.4 V, V _B = 1.2 V	-20		20	
		V _A = -1.4 V, V _B = 1.2 V	-32		0	
I _B	Receiver or transceiver with driver disabled input current	V _B = 3.8 V, V _A = 1.2 V	0		32	μA
		V _B = 0 V or 2.4 V, V _A = 1.2 V	-20		20	
		V _B = -1.4 V, V _A = 1.2 V	-32		0	
I _{AB}	Receiver or transceiver with driver disabled differential input current (I _A – I _B)	V _A = V _B , 1.4 ≤ V _A ≤ 3.8 V	-4		4	μA
I _{A(OFF)}	Receiver or transceiver power-off input current	V _A = 3.8 V, V _B = 1.2 V, 0 V ≤ V _{CC} ≤ 1.5 V	0		32	μA
		V _A = 0 V or 2.4 V, V _B = 1.2 V, 0 V ≤ V _{CC} ≤ 1.5 V	-20		20	
		V _A = -1.4 V, V _B = 1.2 V, 0 V ≤ V _{CC} ≤ 1.5 V	-32		0	
I _{B(OFF)}	Receiver or transceiver power-off input current	V _B = 3.8 V, V _A = 1.2 V, 0 V ≤ V _{CC} ≤ 1.5 V	0		32	μA
		V _B = 0 V or 2.4 V, V _A = 1.2 V, 0 V ≤ V _{CC} ≤ 1.5 V	-20		20	
		V _B = -1.4 V, V _A = 1.2 V, 0 V ≤ V _{CC} ≤ 1.5 V	-32		0	
I _{AB(OFF)}	Receiver input or transceiver power-off differential input current (I _A – I _B)	V _A = V _B , 0 V ≤ V _{CC} ≤ 1.5 V, -1.4 ≤ V _A ≤ 3.8 V	-4		4	μA
C _A	Transceiver with driver disabled input capacitance	V _A = 0.4 sin(30E6πt) + 0.5 V ⁽²⁾ , V _B = 1.2 V		5		pF
C _B	Transceiver with driver disabled input capacitance	V _B = 0.4 sin(30E6πt) + 0.5 V ⁽²⁾ , V _A = 1.2 V		5		pF
C _{AB}	Transceiver with driver disabled differential input capacitance	V _{AB} = 0.4 sin(30E6πt) V ⁽²⁾			3	pF
C _{A/B}	Transceiver with driver disabled input capacitance balance, (C _A /C _B)		0.99		1.01	

(1) All typical values are at 25°C and with a 3.3-V supply voltage.

(2) HP4194A impedance analyzer (or equivalent)

7.9 Switching Characteristics – Driver

over recommended operating conditions unless otherwise noted

PARAMETER		TEST CONDITIONS	MIN	TYP ⁽¹⁾	MAX	UNIT
t_{pLH}	Propagation delay time, low-to-high-level output	See Figure 17	2	2.5	3.5	ns
t_{pHL}	Propagation delay time, high-to-low-level output		2	2.5	3.5	ns
t_r	Differential output signal rise time		2	2.6	3.2	ns
t_f	Differential output signal fall time		2	2.6	3.2	ns
$t_{sk(p)}$	Pulse skew ($t_{pHL} - t_{pLH}$)			30	150	ps
$t_{sk(pp)}$	Part-to-part skew ⁽²⁾				0.9	ns
$t_{jit(per)}$	Period jitter, rms (1 standard deviation) ⁽³⁾	50-MHz clock input ⁽⁴⁾		2	3	ps
$t_{jit(pp)}$	Peak-to-peak jitter ⁽³⁾⁽⁵⁾	100 Mbps 2 ¹⁵ –1 PRBS input ⁽⁶⁾		55	150	ps
t_{PHZ}	Disable time, high-level-to-high-impedance output	See Figure 18		4	7	ns
t_{PLZ}	Disable time, low-level-to-high-impedance output			4	7	ns
t_{PZH}	Enable time, high-impedance-to-high-level output			4	7	ns
t_{PZL}	Enable time, high-impedance-to-low-level output			4	7	ns

(1) All typical values are at 25°C and with a 3.3-V supply voltage.

(2) Part-to-part skew is defined as the difference in propagation delays between two devices that operate at the same V/T conditions.

(3) Jitter is ensured by design and characterization. Stimulus jitter has been subtracted from the numbers.

(4) $t_r = t_f = 0.5$ ns (10% to 90%), measured over 30K samples.

(5) Peak-to-peak jitter includes jitter due to pulse skew ($t_{sk(p)}$).

(6) $t_r = t_f = 0.5$ ns (10% to 90%), measured over 100K samples.

7.10 Switching Characteristics – Receiver

over recommended operating conditions unless otherwise noted

PARAMETER		TEST CONDITIONS	MIN	TYP ⁽¹⁾	MAX	UNIT	
t_{PLH}	Propagation delay time, low-to-high-level output	$C_L = 15$ pF, See Figure 22	2	3.6	6	ns	
t_{pHL}	Propagation delay time, high-to-low-level output		2	3.6	6	ns	
t_r	Output signal rise time		1		2.3	ns	
t_f	Output signal fall time		1		2.3	ns	
$t_{sk(p)}$	Pulse skew ($t_{pHL} - t_{pLH}$)		Type 1		100	300	ps
			Type 2		300	500	ps
$t_{sk(pp)}$	Part-to-part skew ⁽²⁾				1	ns	
$t_{jit(per)}$	Period jitter, rms (1 standard deviation) ⁽³⁾		50-MHz clock input ⁽⁴⁾		4	7	ps
$t_{jit(pp)}$	Peak-to-peak jitter ⁽³⁾⁽⁵⁾		Type 1		200	700	ps
			Type 2		225	800	ps
t_{PHZ}	Disable time, high-level-to-high-impedance output	See Figure 23		6	10	ns	
t_{PLZ}	Disable time, low-level-to-high-impedance output			6	10	ns	
t_{PZH}	Enable time, high-impedance-to-high-level output			10	15	ns	
t_{PZL}	Enable time, high-impedance-to-low-level output			10	15	ns	

(1) All typical values are at 25°C and with a 3.3-V supply voltage.

(2) Part-to-part skew is defined as the difference in propagation delays between two devices that operate at the same V/T conditions.

(3) Jitter is ensured by design and characterization. Stimulus jitter has been subtracted from the numbers.

(4) $V_{ID} = 200$ mV_{pp} (MLVD200A, 202A), $V_{ID} = 400$ mV_{pp} (MLVD204A, 205A), $V_{cm} = 1$ V, $t_r = t_f = 0.5$ ns (10% to 90%), measured over 30K samples.

(5) Peak-to-peak jitter includes jitter due to pulse skew ($t_{sk(p)}$)

(6) $V_{ID} = 200$ mV_{pp} (MLVD200A, 202A), $V_{ID} = 400$ mV_{pp} (MLVD204A, 205A), $V_{cm} = 1$ V, $t_r = t_f = 0.5$ ns (10% to 90%), measured over 100K samples.

7.11 Typical Characteristics

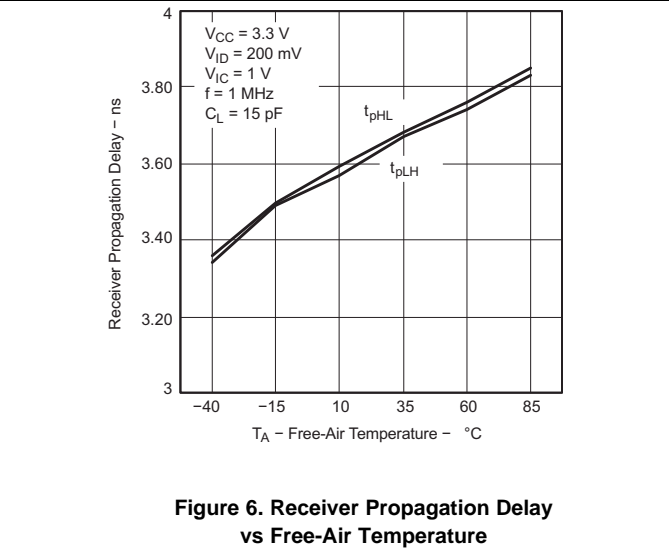
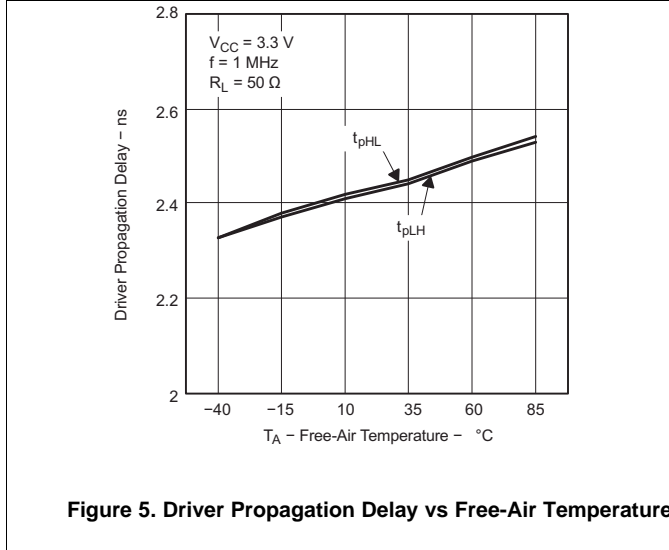
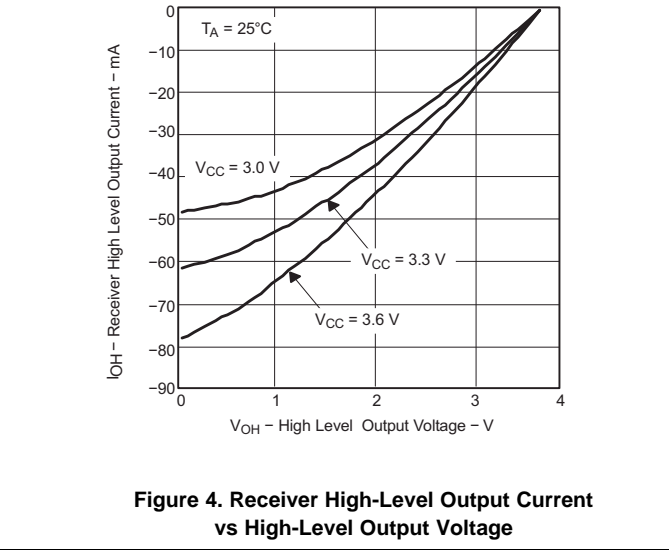
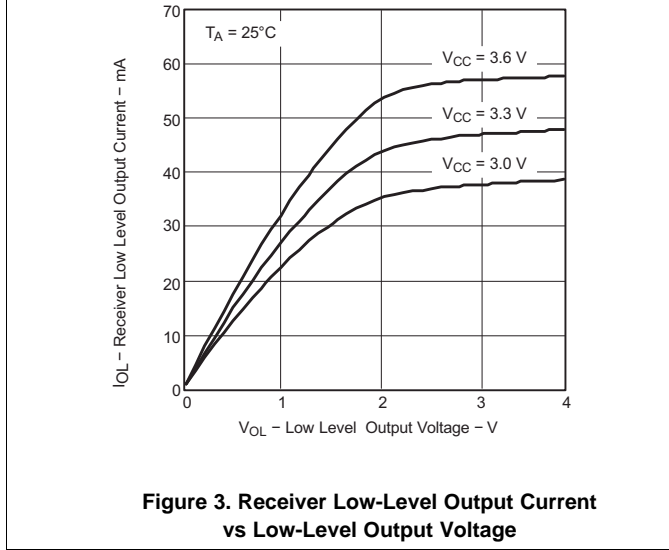
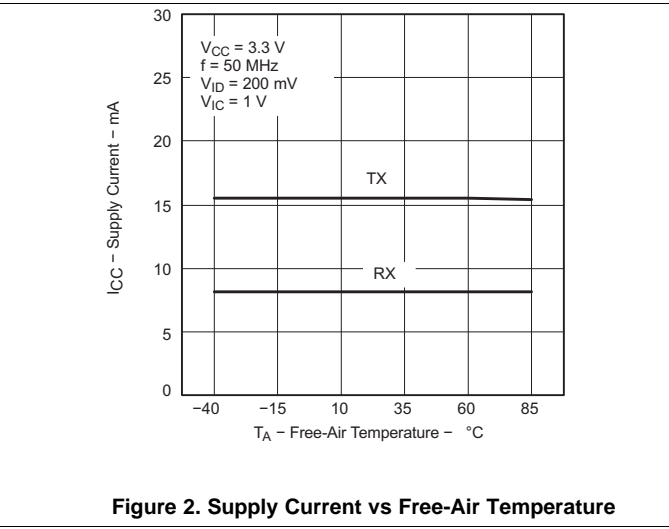
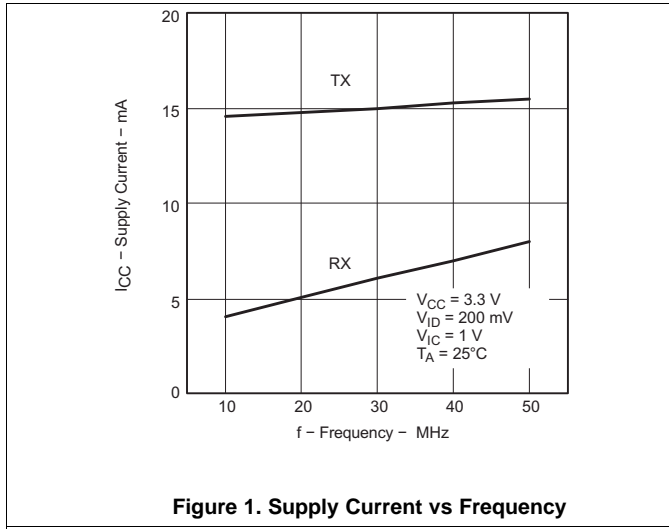

Typical Characteristics (continued)

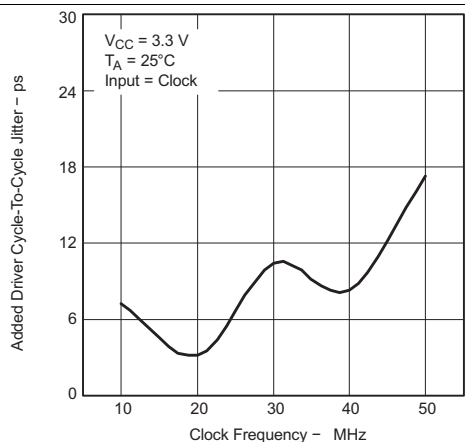

Figure 7. Added Driver Cycle-to-Cycle Jitter vs Clock Frequency

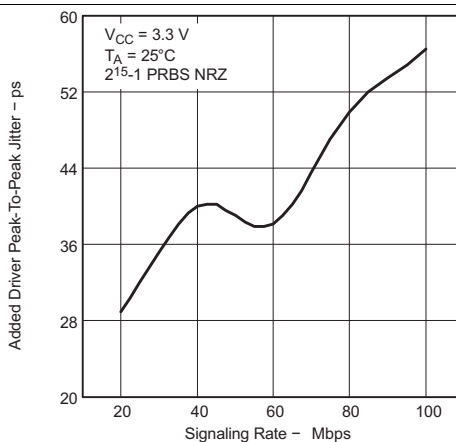

Figure 8. Added Driver Peak-to-Peak Jitter vs Signaling Rate

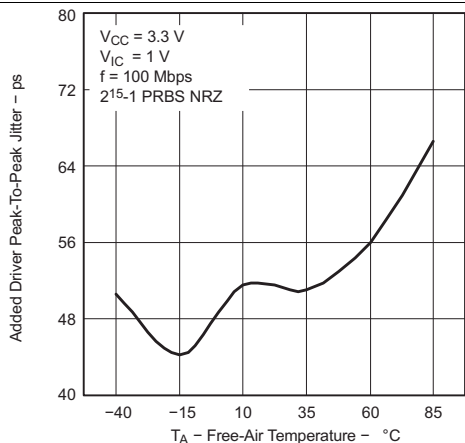

Figure 9. Added Driver Peak-to-Peak Jitter vs Free-Air Temperature

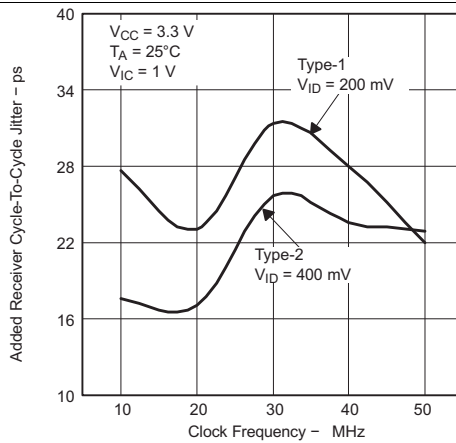

Figure 10. Added Receiver Cycle-to-Cycle Jitter vs Clock Frequency

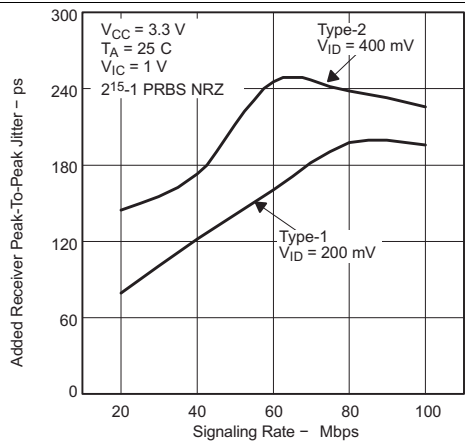

Figure 11. Added Receiver Peak-to-Peak Jitter vs Signaling Rate

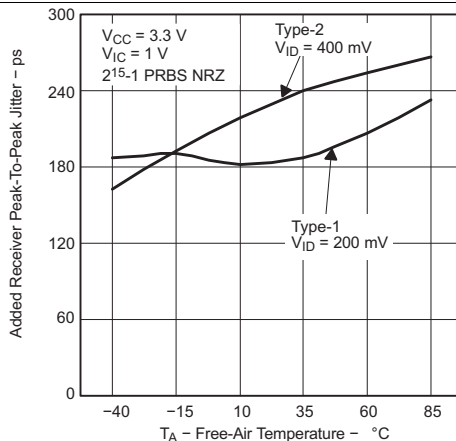

Figure 12. Added Receiver Peak-to-Peak Jitter vs Free-Air Temperature

8 Parameter Measurement Information

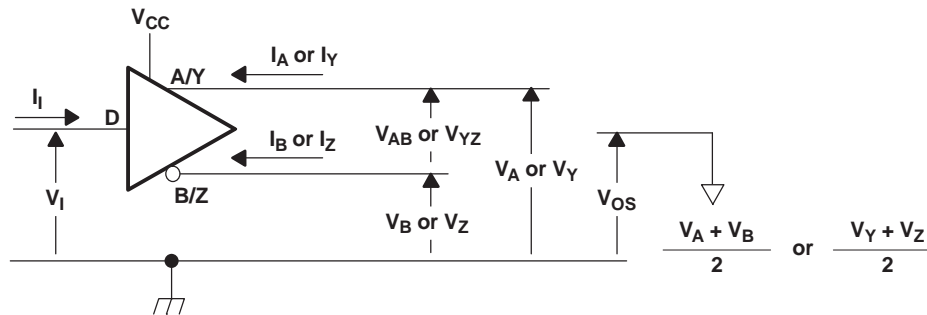
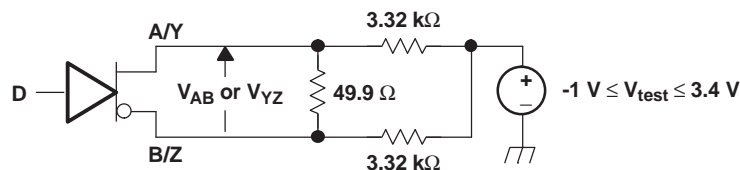
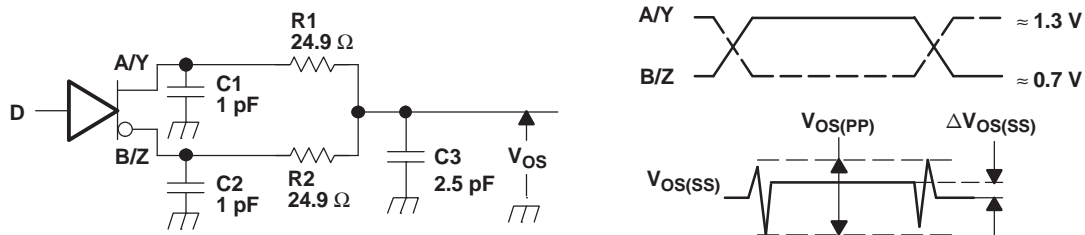

Figure 13. Driver Voltage and Current Definitions



- A. All resistors are 1% tolerance.

Figure 14. Differential Output Voltage Test Circuit



- A. All input pulses are supplied by a generator having the following characteristics: t_r or $t_f \leq 1$ ns, pulse frequency = 1 MHz, duty cycle = $50 \pm 5\%$.
- B. C1, C2 and C3 include instrumentation and fixture capacitance within 2 cm of the D.U.T. and are $\pm 20\%$.
- C. R1 and R2 are metal film, surface mount, $\pm 1\%$, and located within 2 cm of the D.U.T.
- D. The measurement of $V_{OS(PP)}$ is made on test equipment with a -3 dB bandwidth of at least 1 GHz.

Figure 15. Test Circuit and Definitions for the Driver Common-Mode Output Voltage

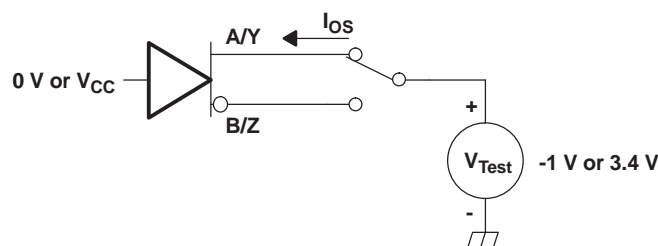
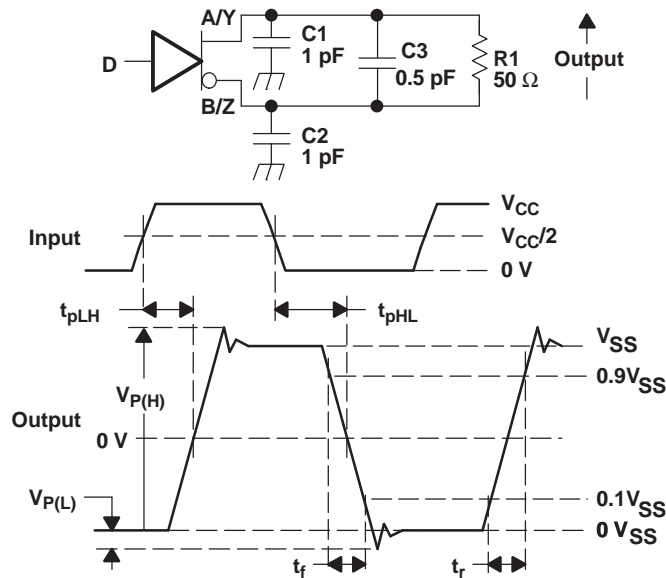

Figure 16. Driver Short-Circuit Test Circuit

Parameter Measurement Information (continued)



- A. All input pulses are supplied by a generator having the following characteristics: t_r or $t_f \leq 1$ ns, frequency = 1 MHz, duty cycle = $50 \pm 5\%$.
- B. C1, C2, and C3 include instrumentation and fixture capacitance within 2 cm of the D.U.T. and are $\pm 20\%$.
- C. R1 is a metal film, surface mount, and 1% tolerance and located within 2 cm of the D.U.T.
- D. The measurement is made on test equipment with a -3 dB bandwidth of at least 1 GHz.

Figure 17. Driver Test Circuit, Timing, and Voltage Definitions for the Differential Output Signal

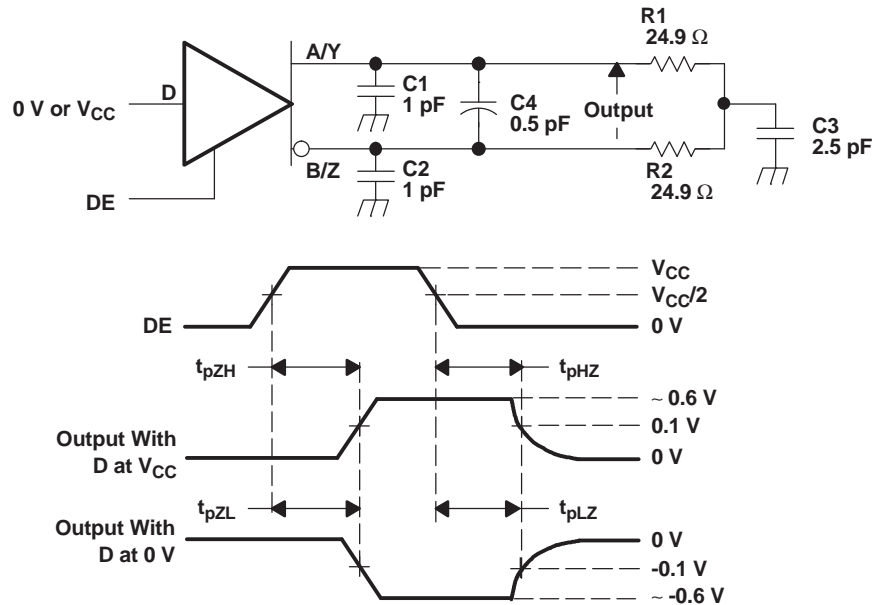

- A. All input pulses are supplied by a generator having the following characteristics: t_r or $t_f \leq 1$ ns, frequency = 1 MHz, duty cycle = $50 \pm 5\%$.
- B. C1, C2, C3, and C4 includes instrumentation and fixture capacitance within 2 cm of the D.U.T. and are $\pm 20\%$.
- C. R1 and R2 are metal film, surface mount, and 1% tolerance and located within 2 cm of the D.U.T.
- D. The measurement is made on test equipment with a -3 dB bandwidth of at least 1 GHz.

Figure 18. Driver Enable and Disable Time Circuit and Definitions

Parameter Measurement Information (continued)

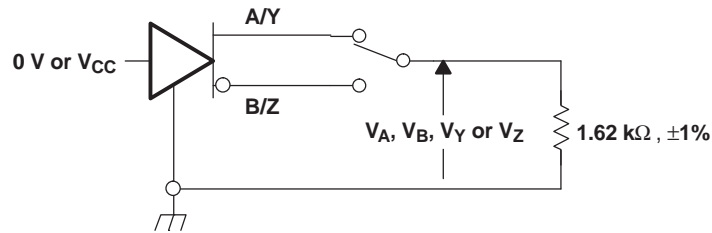
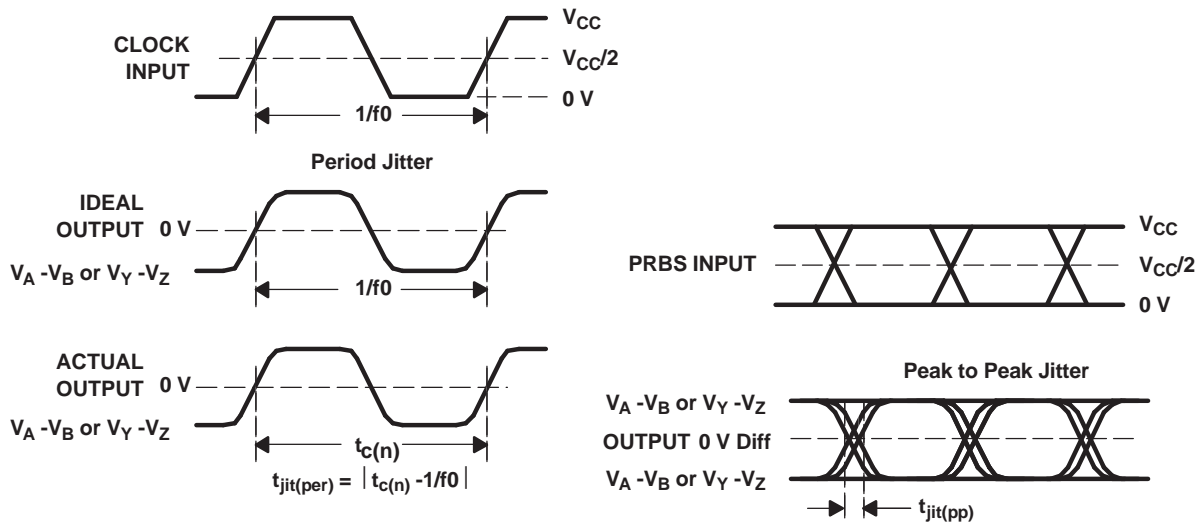

Figure 19. Maximum Steady State Output Voltage



- A. All input pulses are supplied by an Agilent 81250 Stimulus System.
- B. The measurement is made on a TEK TDS6604 running TDSJIT3 application software
- C. Period jitter is measured using a 50 MHz 50 ±1% duty cycle clock input.
- D. Peak-to-peak jitter is measured using a 100 Mbps 2¹⁵ -1 PRBS input.

Figure 20. Driver Jitter Measurement Waveforms

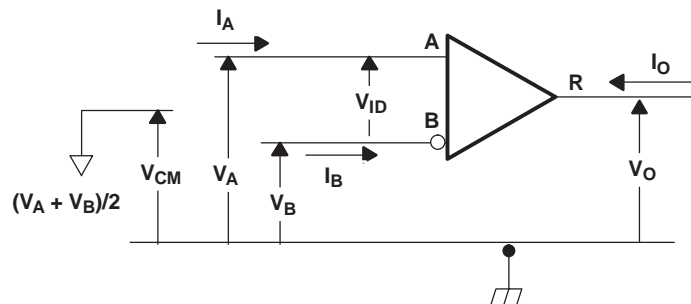

Figure 21. Receiver Voltage and Current Definitions

Table 1. Type-1 Receiver Input Threshold Test Voltages

APPLIED VOLTAGES		RESULTING DIFFERENTIAL INPUT VOLTAGE	RESULTING COMMON-MODE INPUT VOLTAGE	RECEIVER ⁽¹⁾ OUTPUT
V _{IA}	V _{IB}	V _{ID}	V _{IC}	
2.400	0.000	2.400	1.200	H
0.000	2.400	-2.400	1.200	L
3.425	3.335	0.050	3.4	H
3.375	3.425	-0.050	3.4	L
-0.975	-1.025	0.050	-1	H
-1.025	-0.975	-0.050	-1	L

(1) H= high level, L = low level, output state assumes receiver is enabled ($\overline{RE} = L$)

Table 2. Type-2 Receiver Input Threshold Test Voltages

APPLIED VOLTAGES		RESULTING DIFFERENTIAL INPUT VOLTAGE	RESULTING COMMON-MODE INPUT VOLTAGE	RECEIVER OUTPUT ⁽¹⁾
V _{IA}	V _{IB}	V _{ID}	V _{IC}	
2.400	0.000	2.400	1.200	H
0.000	2.400	-2.400	1.200	L
3.475	3.325	0.150	3.4	H
3.425	3.375	0.050	3.4	L
-0.925	-1.075	0.150	-1	H
-0.975	-1.025	0.050	-1	L

(1) H= high level, L = low level, output state assumes receiver is enabled ($\overline{RE} = L$)

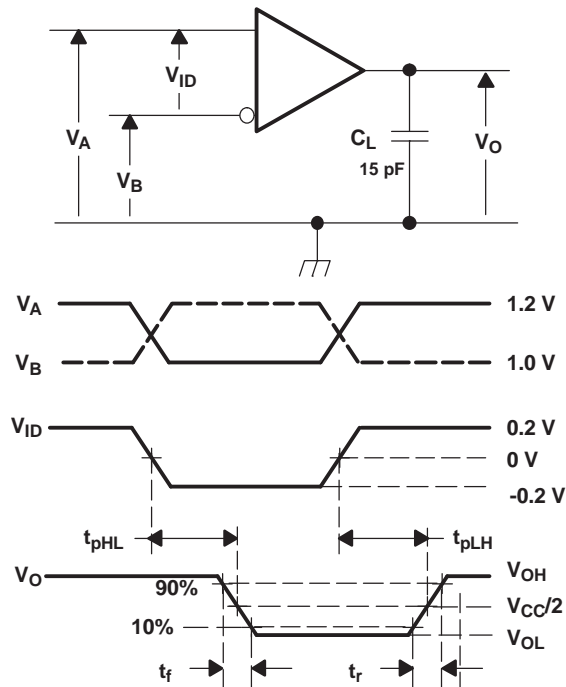

- All input pulses are supplied by a generator having the following characteristics: t_r or $t_f \leq 1 \text{ ns}$, frequency = 1 MHz, duty cycle = $50 \pm 5\%$. C_L is a combination of a 20%-tolerance, low-loss ceramic, surface-mount capacitor and fixture capacitance within 2 cm of the D.U.T.
- The measurement is made on test equipment with a -3 dB bandwidth of at least 1 GHz.

Figure 22. Receiver Timing Test Circuit and Waveforms

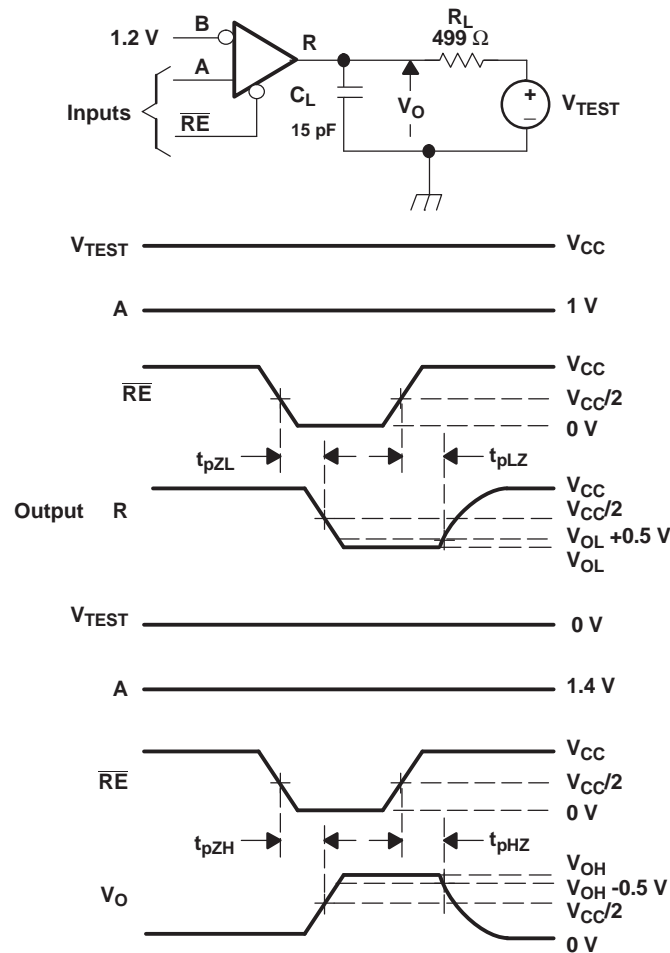

- All input pulses are supplied by a generator having the following characteristics: t_r or $t_f \leq 1$ ns, frequency = 1 MHz, duty cycle = $50 \pm 5\%$.
- R_L is 1% tolerance, metal film, surface mount, and located within 2 cm of the D.U.T.
- C_L is the instrumentation and fixture capacitance within 2 cm of the DUT and $\pm 20\%$.

Figure 23. Receiver Enable and Disable Time Test Circuit and Waveforms

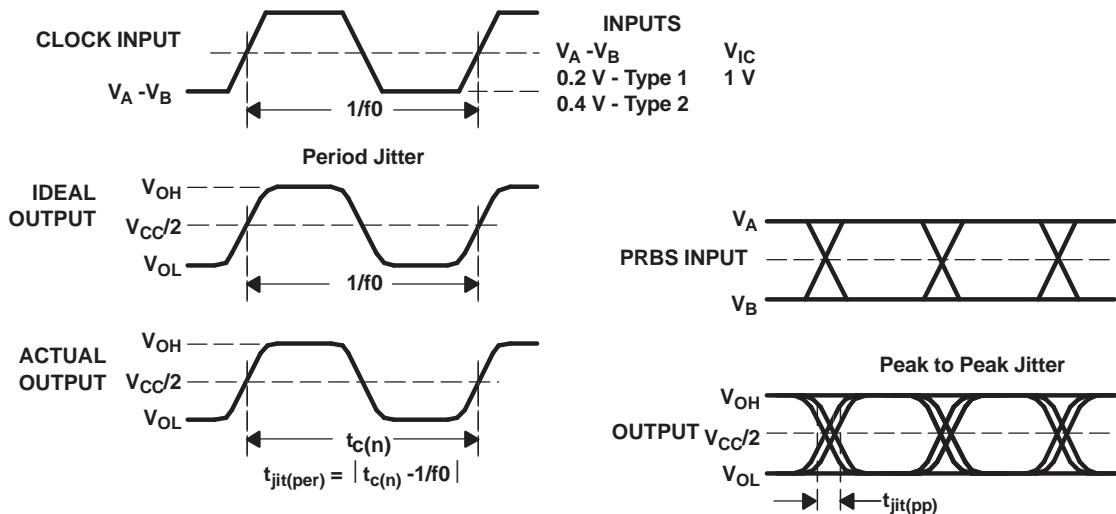

- A. All input pulses are supplied by an Agilent 8304A Stimulus System.
- B. The measurement is made on a TEK TDS6604 running TDSJIT3 application software
- C. Period jitter is measured using a 50 MHz 50 \pm 1% duty cycle clock input.
- D. Peak-to-peak jitter is measured using a 100 Mbps $2^{15} - 1$ PRBS input.

Figure 24. Receiver Jitter Measurement Waveforms

9 Detailed Description

9.1 Overview

The SN65MLVD20xA family of devices are multipoint-low-voltage differential (M-LVDS) line drivers and receivers that are optimized to operate at signaling rates up to 100 Mbps. All parts comply with the multipoint low-voltage differential signaling (M-LVDS) standard TIA/EIA-899. These circuits are similar to their TIA/EIA-644 standard compliant LVDS counterparts with added features to address multipoint applications. The driver output has been designed to support multipoint buses presenting loads as low as 30 Ω and incorporates controlled transition times to allow for stubs off of the backbone transmission line.

These devices have Type-1 and Type-2 receivers that detect the bus state with as little as 50 mV (for Type-1) or 150 mV (for Type-2) of differential input voltage over a common-mode voltage range of -1 V to 3.4 V. The Type-1 receivers exhibit 25 mV of differential input voltage hysteresis to prevent output oscillations with slowly changing signals or loss of input. Type-2 receivers include an offset threshold to provide a known output state under open-circuit and bus-idle fault conditions.

9.2 Functional Block Diagram

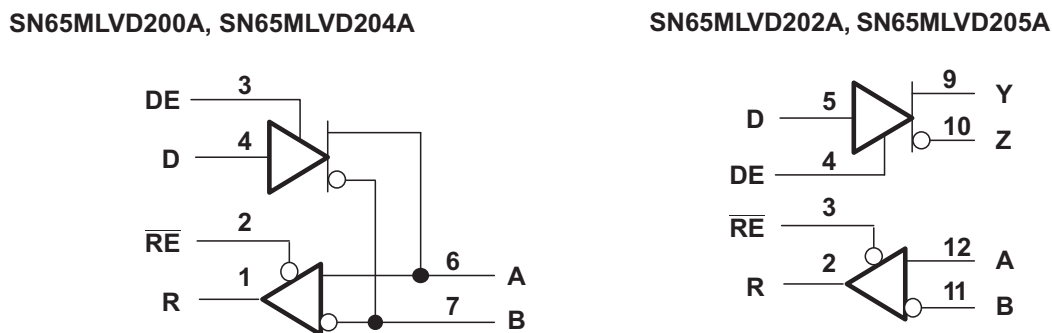

Figure 25. Logic Diagrams (Positive Logic)

9.3 Feature Description

9.3.1 Power-On Reset

This family of devices operates and meets all the specified performance requirements for supply voltages in the range of 3 V to 3.6 V. When the supply voltage drops below 1.5 V (or is turning on and has not yet reached 1.5 V), power-on reset circuitry sets the driver output to a high-impedance state.

9.3.2 ESD Protection

The bus terminals of the SN65MLVD20xA devices possess on-chip ESD protection against ± 8 -kV human body model (HBM) and ± 8 kV.

9.4 Device Functional Modes

9.4.1 Device Function Tables

Table 3. Type-1 Receiver (SN65MLVD200A)⁽¹⁾

INPUTS		OUTPUT
$V_{ID} = V_A - V_B$	\overline{RE}	R
$V_{ID} \geq 50 \text{ mV}$	L	H
$-50 \text{ mV} < V_{ID} < 50 \text{ mV}$	L	?
$V_{ID} \leq -50 \text{ mV}$	L	L
X	H	Z
X	Open	Z

(1) H = high level, L = low level, Z = high impedance, X = Don't care, ? = indeterminate

Table 4. Type-2 Receiver (SN65MLVD204A)⁽¹⁾

INPUTS		OUTPUT
$V_{ID} = V_A - V_B$	\overline{RE}	R
$V_{ID} \geq 150 \text{ mV}$	L	H
$50 \text{ mV} < V_{ID} < 150 \text{ mV}$	L	?
$V_{ID} \leq 50 \text{ mV}$	L	L
X	H	Z
X	Open	Z

(1) H = high level, L = low level, Z = high impedance, X = Don't care, ? = indeterminate

Table 5. Driver⁽¹⁾

INPUTS	ENABLE	OUTPUTS	
		A	B
D	DE		
L	H	L	H
H	H	H	L
Open	H	L	H
X	Open	Z	Z
X	L	Z	Z

(1) H = high level, L = low level, Z = high impedance, X = Don't care, ? = indeterminate

9.4.2 Equivalent Input and Output Schematic Diagrams

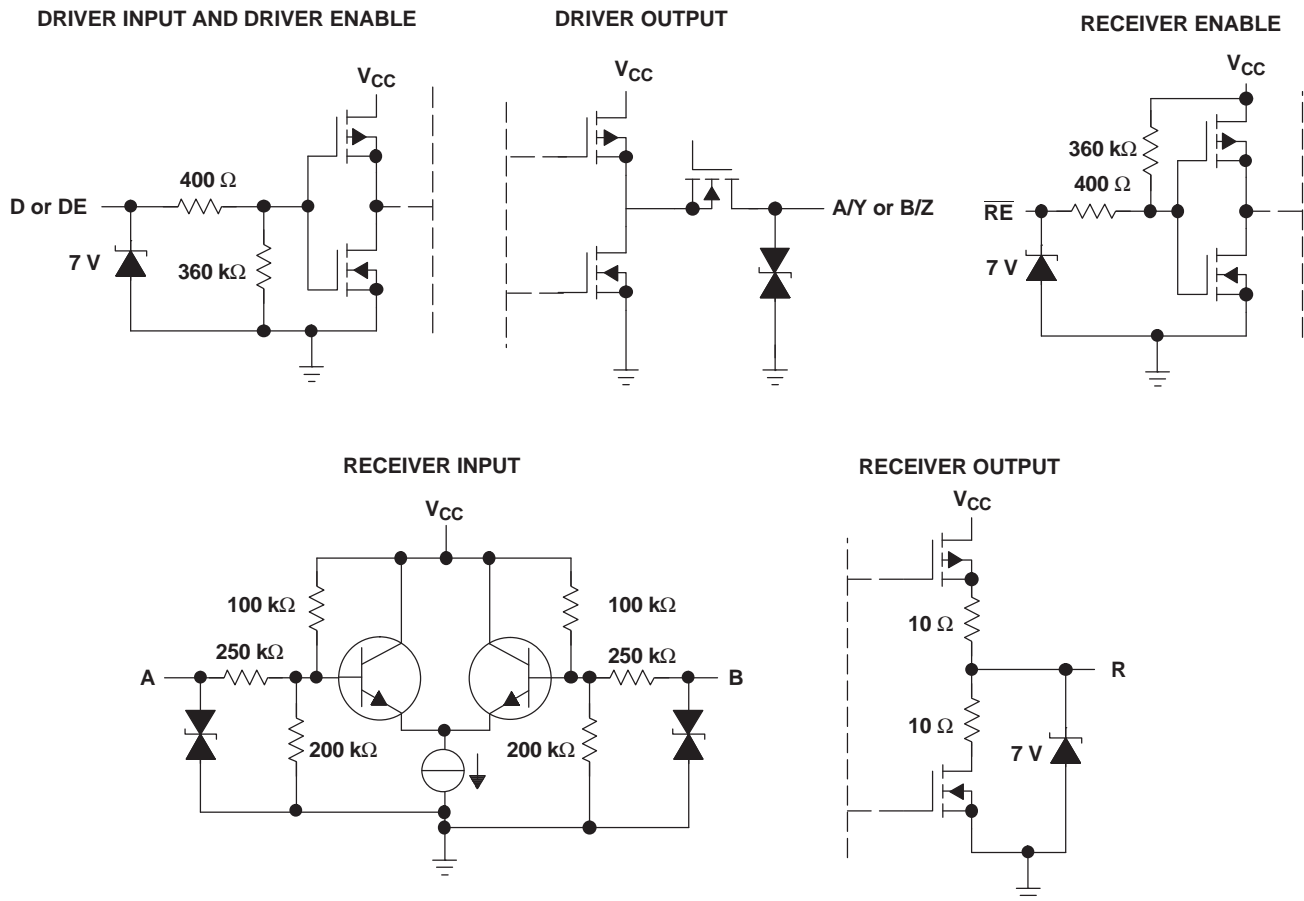

10 Application and Implementation

NOTE

Information in the following applications sections is not part of the TI component specification, and TI does not warrant its accuracy or completeness. TI's customers are responsible for determining suitability of components for their purposes. Customers should validate and test their design implementation to confirm system functionality.

10.1 Application Information

The SN65MLVD20xA family of devices are multipoint line drivers and receivers. The functionality of these devices is simple, yet extremely flexible, thus leading to their use in designs ranging from wireless base stations to desktop computers.

10.2 Typical Application

Figure 26 shows a multipoint configuration. In a multipoint configuration, many transmitters and many receivers can be interconnected on one transmission line. The key difference compared to multidrop is the presence of two or more drivers. Such a situation creates contention issues that must not be addressed with point-to-point or multidrop systems. Multipoint operation allows for bidirectional, half-duplex communication over one balanced media pair. To support the location of the various drivers throughout the transmission line, double termination of the transmission line is now necessary.

The major challenge that system designers encounter are the impedance discontinuities that device loading and device connections (stubs) introduce on the common bus. Matching the impedance of the loaded bus and using signal drivers with controlled signal edges are the keys to error-free signal transmissions in multipoint topologies.

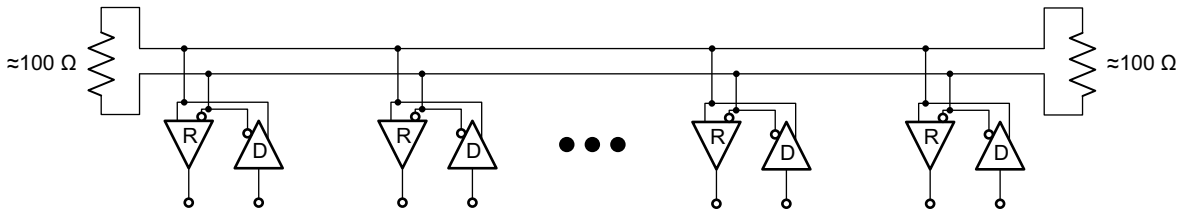

Figure 26. Multipoint Configuration

10.2.1 Design Requirements

For this design example, use the parameters listed in Table 6.

Table 6. Design Parameters

PARAMETERS	VALUES
Driver supply voltage	3 V to 3.6 V
Driver input voltage	0.8 V to 3.3 V
Driver signaling rate	DC to 100 Mbps
Interconnect characteristic impedance (differential)	100 Ω
Termination resistance	100 Ω
Number of receiver nodes	2 to 32
Receiver supply voltage	3 V to 3.6 V
Receiver input voltage	0 to (V _{CC} – 0.8) V
Receiver signaling rate	DC to 100 Mbps
Ground shift between driver and receiver	±1 V

10.2.2 Detailed Design Procedure

10.2.2.1 Supply Voltage

The SN65MLVD20xA devices are operated from one supply. The SN65MLVD20xA devices can support operation with a supply as low as 3 V and as high as 3.6 V.

10.2.2.2 Supply Bypass Capacitance

Bypass capacitors play a key role in power distribution circuitry. At low frequencies, power supply offers very low-impedance paths between its terminals. However, as higher frequency currents propagate through power traces, the source is often incapable of maintaining a low-impedance path to ground. Bypass capacitors are used to address this shortcoming. Usually, large bypass capacitors (10 μ F to 1000 μ F) at the board level do a good job up into the kHz range. Due to their size and length of their leads, large capacitors tend to have large inductance values at the switching frequencies. To solve this problem, smaller capacitors (in the nF to μ F range) must be installed locally next to the integrated circuit.

Multilayer ceramic chip or surface-mount capacitors (size 0603 or 0805) minimize lead inductances of bypass capacitors in high-speed environments, because their lead inductance is about 1 nH. For comparison purposes, a typical capacitor with leads has a lead inductance around 5 nH.

The value of the bypass capacitors used locally with M-LVDS chips can be determined by [Equation 1](#) and [Equation 2](#), according to *High Speed Digital Design – A Handbook of Black Magic* by Howard Johnson and Martin Graham (1993). A conservative rise time of 4 ns and a worst-case change in supply current of 100 mA covers the whole range of M-LVDS devices offered by Texas Instruments. In this example, the maximum power supply noise tolerated is 100 mV; however, this figure varies depending on the noise budget available for the design.

$$C_{\text{chip}} = \left(\frac{\Delta I_{\text{Maximum Step Change Supply Current}}}{\Delta V_{\text{Maximum Power Supply Noise}}} \right) \times T_{\text{Rise Time}} \quad (1)$$

$$C_{\text{MLVDS}} = \left(\frac{100 \text{ mA}}{100 \text{ mV}} \right) \times 4 \text{ ns} = 0.004 \mu\text{F} \quad (2)$$

[Figure 27](#) shows a configuration that lowers lead inductance and covers intermediate frequencies between the board-level capacitor (>10 μ F) and the value of capacitance found above (0.004 μ F). Place the smallest value of capacitance as close as possible to the chip.

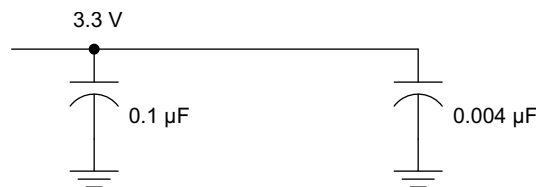

Figure 27. Recommended M-LVDS Bypass Capacitor Layout

10.2.2.3 Driver Input Voltage

The input stage accepts LVTTTL signals. The driver will operate with a decision threshold of approximately 1.4 V.

10.2.2.4 Driver Output Voltage

The driver outputs a steady state common mode voltage of 1 V with a differential signal of 540 V under nominal conditions.

10.2.2.5 Termination Resistors

An M-LVDS communication channel employs a current source driving a transmission line that is terminated with two resistive loads. These loads serve to convert the transmitted current into a voltage at the receiver input. To ensure good signal integrity, the termination resistors must be matched to the characteristic impedance of the transmission line. The designer must ensure that the termination resistors are within 10% of the nominal media characteristic impedance. If the transmission line is targeted for 100-Ω impedance, the termination resistors must be between 90 Ω and 110 Ω. The line termination resistors are typically placed at the ends of the transmission line.

10.2.2.6 Receiver Input Signal

The M-LVDS receivers herein comply with the M-LVDS standard and correctly determine the bus state. These devices have Type-1 and Type-2 receivers that detect the bus state with as little as 50 mV of differential voltage over the common mode range of -1 V to 3.4 V.

10.2.2.7 Receiver Input Threshold (Failsafe)

The M-LVDS standard defines a Type-1 and a Type-2 receiver. Type-1 receivers have differential input voltage thresholds near zero volts. Type-2 receivers have differential input voltage thresholds offset from 0 V to detect the absence of a voltage difference. The impact to receiver output by the offset input can be seen in Table 7 and Figure 28.

Table 7. Receiver Input Voltage Threshold Requirements

RECEIVER TYPE	OUTPUT LOW	OUTPUT HIGH
Type 1	$-2.4\text{ V} \leq V_{ID} \leq -0.05\text{ V}$	$0.05\text{ V} \leq V_{ID} \leq 2.4\text{ V}$
Type 2	$-2.4\text{ V} \leq V_{ID} \leq 0.05\text{ V}$	$0.15\text{ V} \leq V_{ID} \leq 2.4\text{ V}$

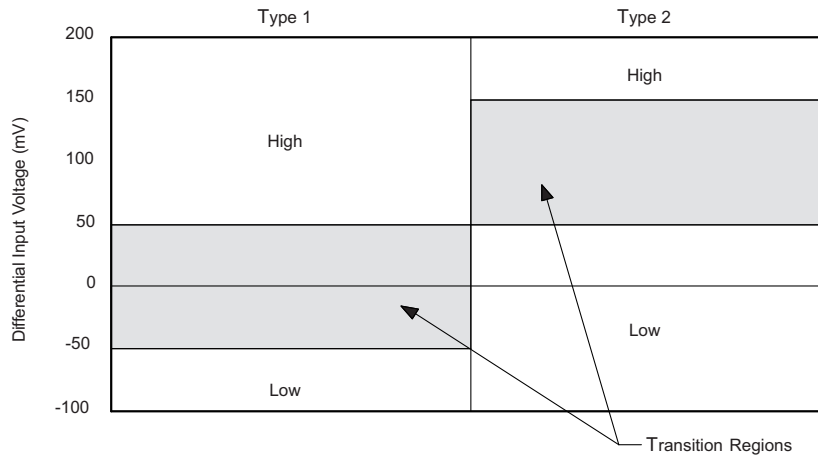

Figure 28. Expanded Graph of Receiver Differential Input Voltage Showing Transition Region

10.2.2.8 Receiver Output Signal

Receiver outputs comply with LVTTTL output voltage standards when the supply voltage is within the range of 3 V to 3.6 V.

10.2.2.9 Interconnecting Media

The physical communication channel between the driver and the receiver may be any balanced, paired metal conductors that meet the requirements of the M-LVDS standard—the key points are included in the following. The interconnecting media may be a twisted pair, twinax, flat ribbon cable, or PCB traces.

The nominal characteristic impedance of the interconnect must be between 100 Ω and 120 Ω with variation no more than 10% (90 Ω to 132 Ω).

10.2.2.10 PCB Transmission Lines

The *LVDS Owner's Manual Design Guide, 4th Edition (SNLA187)*, Figure 29 depicts several transmission line structures commonly used in printed-circuit boards (PCBs). Each structure consists of a signal line and a return path with uniform cross-section along its length. A microstrip is a signal trace on the top (or bottom) layer that is separated by a dielectric layer from its return path in a ground or power plane. A stripline is a signal trace in the inner layer, with a dielectric layer in between a ground plane above and below the signal trace. The dimensions of the structure along with the dielectric material properties determine the characteristic impedance of the transmission line, which is also called *controlled-impedance transmission line*.

When two signal lines are placed close together, they form a pair of coupled transmission lines. Figure 29 shows examples of edge-coupled microstrips and edge-coupled or broad-side-coupled striplines. When excited by differential signals, the coupled transmission line is referred to as a differential pair. The characteristic impedance of each line is called *odd-mode impedance*. The sum of the odd-mode impedances of each line is the differential impedance of the differential pair. In addition to the trace dimensions and dielectric material properties, the spacing between the two traces determines the mutual coupling and impacts the differential impedance. When the two lines are immediately adjacent (for example, if S is less than $2 \times W$) the differential pair is called a tightly-coupled differential pair. To maintain constant differential impedance along the length, it is important to keep the trace width and spacing uniform along the length and to maintain good symmetry between the two lines.

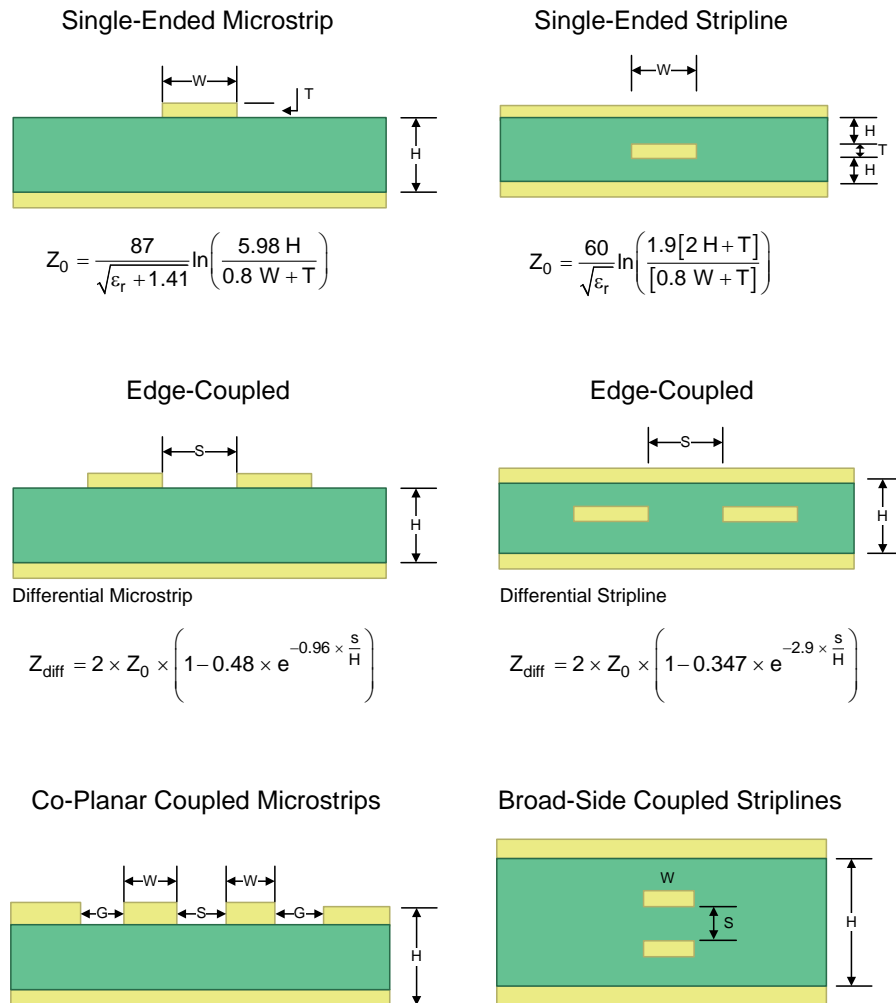
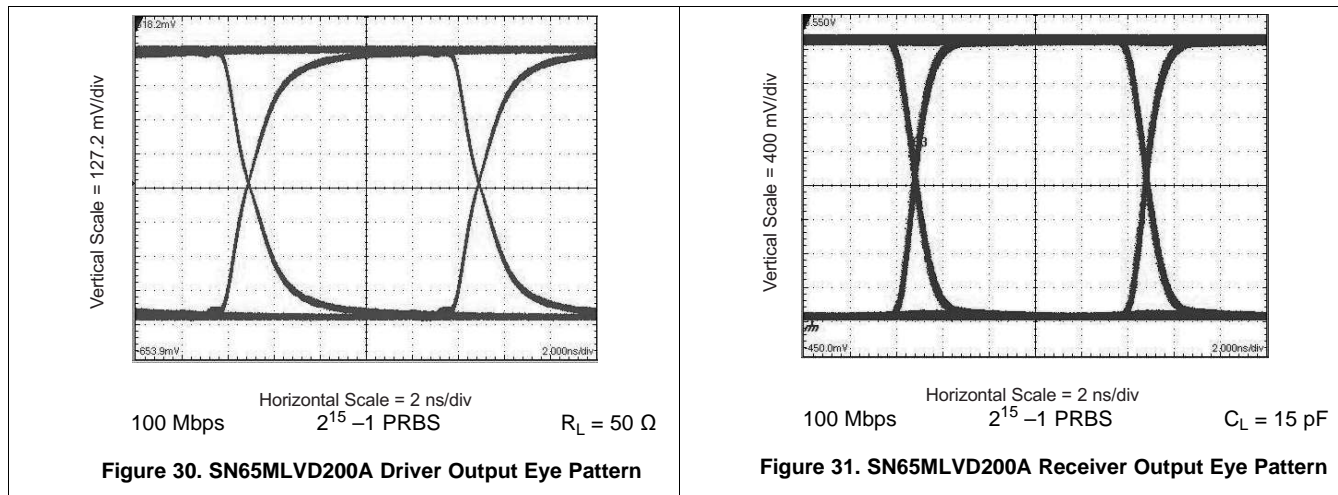

Figure 29. Controlled-Impedance Transmission Lines

10.2.3 Application Curves



11 Power Supply Recommendations

The M-LVDS drivers and receivers in this data sheet are designed to operate from one power supply. Both drivers and receivers operate with supply voltages in the range of 3 V to 3.6 V. In a typical application, a driver and a receiver may be on separate boards or even separate equipment. In these cases, separate supplies must be used at each location. The expected ground potential difference between the driver power supply and the receiver power supply would be less than ± 1 V. Board level and local device level bypass capacitance must be used and are covered supply bypass capacitance.

12 Layout

12.1 Layout Guidelines

12.1.1 Microstrip Versus Stripline Topologies

According to the *LVDS Application and Data Handbook* (SLLD009), printed-circuit boards usually offer designers two transmission line options: microstrip and stripline. Microstrips are traces on the outer layer of a PCB, as shown in Figure 32.

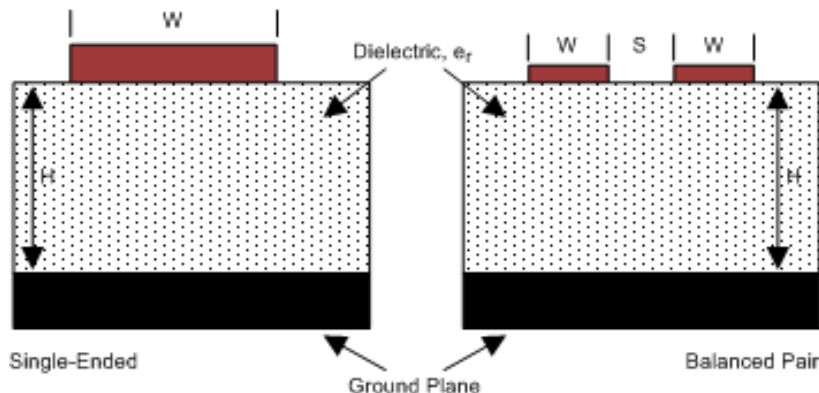

Figure 32. Microstrip Topology

Layout Guidelines (continued)

Striplines are traces between two ground planes (see Figure 33). Striplines are less prone to emissions and susceptibility problems because the reference planes effectively shield the embedded traces. However, from the standpoint of high-speed transmission, juxtaposing two planes creates additional capacitance. TI recommends routing M-LVDS signals on microstrip transmission lines if possible. The PCB traces allow designers to specify the necessary tolerances for Z_0 based on the overall noise budget and reflection allowances. Footnotes 1⁽¹⁾, 2⁽²⁾, and 3⁽³⁾ provide the documentation for formulas for Z_0 and t_{PD} for differential and single-ended traces. ⁽¹⁾ ⁽²⁾ ⁽³⁾

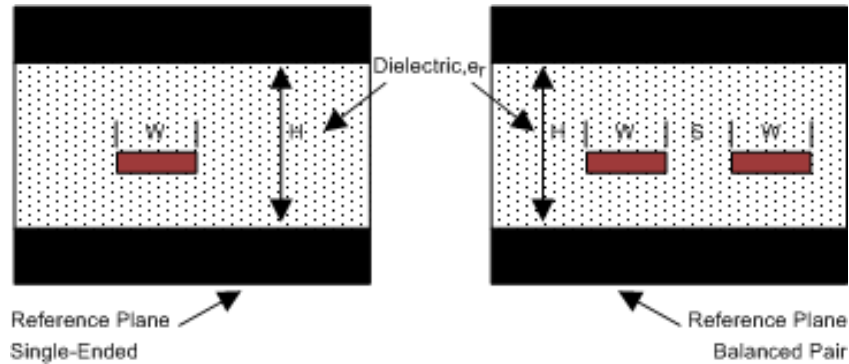

Figure 33. Stripline Topology

12.1.2 Dielectric Type and Board Construction

The speeds at which signals travel across the board dictates the choice of dielectric. FR-4, or equivalent, usually provides adequate performance for use with M-LVDS signals. If rise or fall times of TTL/CMOS signals are less than 500 ps, empirical results indicate that a material with a dielectric constant near 3.4, such as Rogers™ 4350 or Nelco N4000-13 is better suited. When the designer chooses the dielectric, there are several parameters pertaining to the board construction that can affect performance. The following set of guidelines were developed experimentally through several designs involving M-LVDS devices:

- Copper weight: 15 g or ½ oz start, plated to 30 g or 1 oz
- All exposed circuitry must be solder-plated (60/40) to 7.62 μm or 0.0003 in (minimum)
- Copper plating must be 25.4 μm or 0.001 in (minimum) in plated-through-holes
- Solder mask over bare copper with solder hot-air leveling

12.1.3 Recommended Stack Layout

Following the choice of dielectrics and design specifications, the designer must decide how many levels to use in the stack. To reduce the TTL/CMOS to M-LVDS crosstalk, it is a good practice to have at least two separate signal planes as shown in Figure 34.

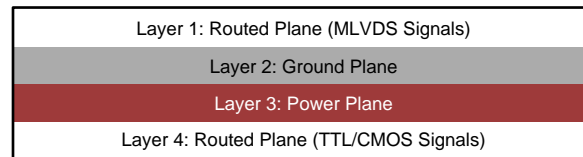

Figure 34. Four-Layer PCB Board

NOTE

The separation between layers 2 and 3 must be 127 μm (0.005 in). By keeping the power and ground planes tightly coupled, the increased capacitance acts as a bypass for transients.

(1) Howard Johnson and Martin Graham. 1993. *High Speed Digital Design – A Handbook of Black Magic*. Prentice Hall PRT. ISBN number 013395724.

(2) Mark I. Montrose. 1996. *Printed Circuit Board Design Techniques for EMC Compliance*. IEEE Press. ISBN number 0780311310.

(3) Clyde F. Coombs. 1995. *Printed Circuits Handbook*. McGraw Hill. ISBN number 0070127549.

Layout Guidelines (continued)

One of the most common stack configurations is the six-layer board, as shown in Figure 35.

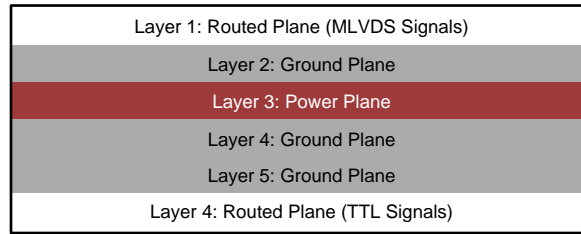

Figure 35. Six-Layer PCB Board

In this particular configuration, it is possible to isolate each signal layer from the power plane by at least one ground plane. The result is improved signal integrity; however, fabrication is more expensive. Using the 6-layer board is preferable because it offers the layout designer more flexibility in varying the distance between signal layers and referenced planes, in addition to ensuring reference to a ground plane for signal layers 1 and 6.

12.1.4 Separation Between Traces

The separation between traces depends on several factors; however, the amount of coupling that can be tolerated usually dictates the actual separation. Low-noise coupling requires close coupling between the differential pair of an M-LVDS link to benefit from the electromagnetic field cancellation. The traces must be 100-Ω differential and coupled in the manner that best fits this requirement. In addition, differential pairs must have the same electrical length to ensure that they are balanced, thus minimizing problems with skew and signal reflection.

In the case of two adjacent single-ended traces, one must use the 3-W rule, which stipulates that the distance between two traces must be greater than two times the width of one trace, or three times its width measured from trace center to trace center. This increased separation effectively reduces the potential for crosstalk. The same rule must be applied to the separation between adjacent M-LVDS differential pairs, whether the traces are edge-coupled or broad-side-coupled.

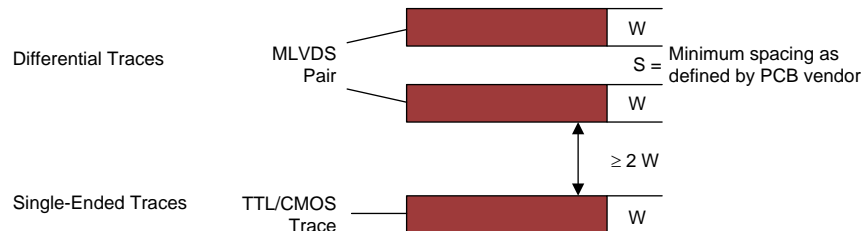

Figure 36. 3-W Rule for Single-Ended and Differential Traces (Top View)

Exercise caution when using autorouters because they do not always account for all factors affecting crosstalk and signal reflection. For instance, it is best to avoid sharp 90° turns to prevent discontinuities in the signal path. Using successive 45° turns tends to minimize reflections.

12.1.5 Crosstalk and Ground Bounce Minimization

To reduce crosstalk, it is important to provide a return path to high-frequency currents that is as close as possible to its originating trace. A ground plane usually achieves this. Because the returning currents always choose the path of lowest inductance, they are most likely to return directly under the original trace, thus minimizing crosstalk. Lowering the area of the current loop lowers the potential for crosstalk. Traces kept as short as possible with an uninterrupted ground plane running beneath them emit the minimum amount of electromagnetic field strength. Discontinuities in the ground plane increase the return path inductance and must be avoided.

Layout Guidelines (continued)

12.1.6 Decoupling

Each power or ground lead of a high-speed device must be connected to the PCB through a low inductance path. For best results, one or more vias are used to connect a power or ground pin to the nearby plane. Ideally, via placement is immediately adjacent to the pin to avoid adding trace inductance. Placing a power plane closer to the top of the board reduces the effective via length and its associated inductance.

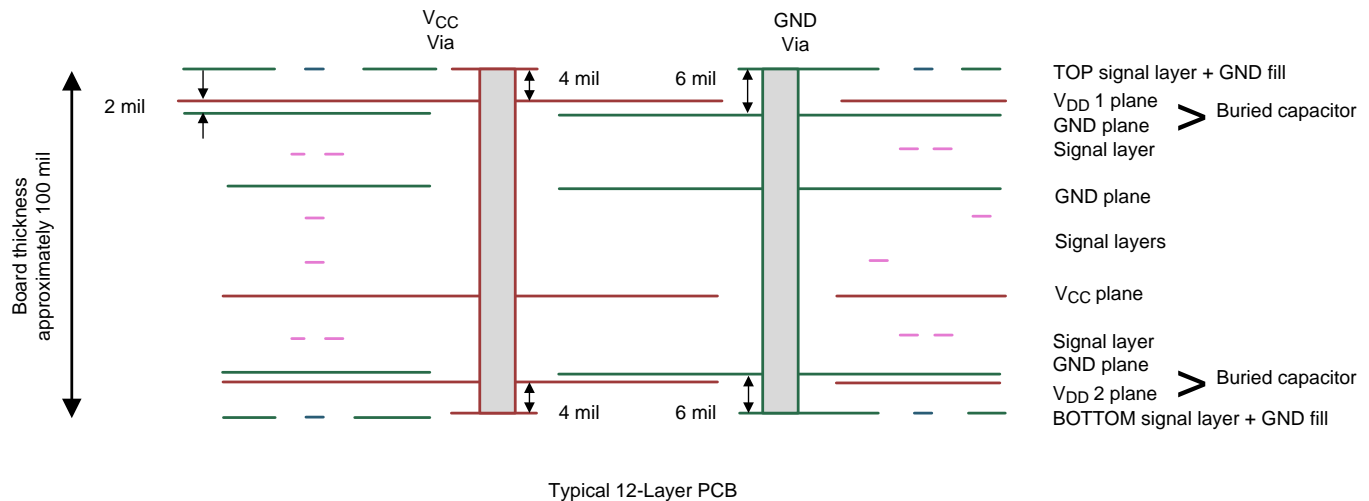

Figure 37. Low Inductance, High-Capacitance Power Connection

Bypass capacitors must be placed close to V_{DD} pins and can be placed conveniently near the corners or underneath the package to minimize the loop area. This extends the useful frequency range of the added capacitance. Small physical-size capacitors (such as 0402, 0201, or X7R surface-mount capacitors) must be used to minimize body inductance of capacitors. Each bypass capacitor is connected to the power and ground plane through vias tangent to the pads of the capacitor as shown in Figure 38(a).

An X7R surface-mount capacitor of size 0402 has about 0.5 nH of body inductance. At frequencies above about 30 MHz, X7R capacitors behave as low-impedance inductors. To extend the operating frequency range to a few hundred MHz, an array of different capacitor values like 100 pF, 1 nF, 0.03 μ F, and 0.1 μ F are commonly used in parallel. The most effective bypass capacitor can be built using sandwiched layers of power and ground at a separation of 2 to 3 mils. With a 2-mil FR4 dielectric, there is approximately 500 pF per square inch of PCB.

Many high-speed devices provide a low-inductance GND connection on the backside of the package. This center pad must be connected to a ground plane through an array of vias. The via array reduces the effective inductance to ground and enhances the thermal performance of the small surface mount technology (SMT) package. Placing vias around the perimeter of the pad connection ensures proper heat spreading and the lowest possible die temperature. Placing high-performance devices on opposing sides of the PCB using two GND planes (as shown in Figure 29) creates multiple paths for heat transfer.

Thermal PCB issues are often the result of one device adding heat to another, resulting in a very high local temperature. Multiple paths for heat transfer minimize this possibility. In many cases, the GND pad that is so important for heat dissipation makes the optimal decoupling layout impossible to achieve, due to insufficient pad-to-pad spacing as shown in Figure 39(b). When this occurs, placing the decoupling capacitor on the backside of the board keeps the extra inductance to a minimum.

Layout Guidelines (continued)

It is important to place the V_{DD} via as close to the device pin as possible while still allowing for sufficient solder mask coverage. If the via is left open, solder may flow from the pad into the via barrel, which results in a poor solder connection



Figure 38. Typical Decoupling Capacitor Layout (a)

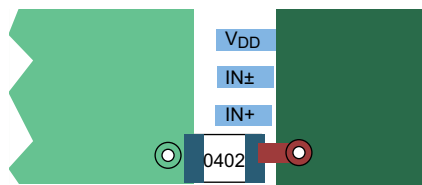

Figure 39. Typical Decoupling Capacitor Layout (b)

12.2 Layout Example

At least two or three times the width of an individual trace must separate single-ended traces and differential pairs to minimize the potential for crosstalk. Single-ended traces that run in parallel for less than the wavelength of the rise or fall times usually have negligible crosstalk. Increase the spacing between signal paths for long parallel runs to reduce crosstalk. Boards with limited real estate can benefit from the staggered trace layout, as shown in [Figure 40](#).

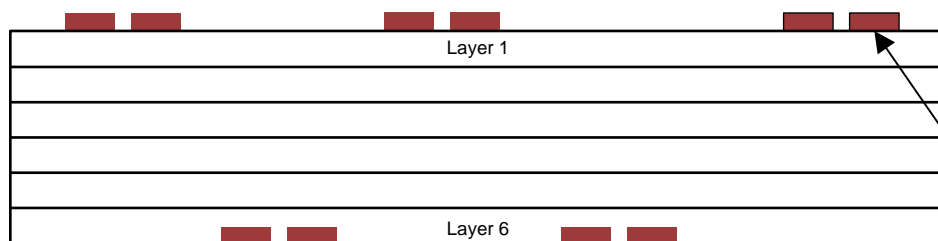

Figure 40. Staggered Trace Layout

This configuration lays out alternating signal traces on different layers; thus, the horizontal separation between traces can be less than 2 or 3 times the width of individual traces. To ensure continuity in the ground signal path, TI recommends having an adjacent ground via for every signal via, as shown in [Figure 41](#).

NOTE

Vias create additional capacitance. For example, a typical via has a lumped capacitance effect of $\frac{1}{2}$ pF to 1 pF in FR4.

Layout Example (continued)

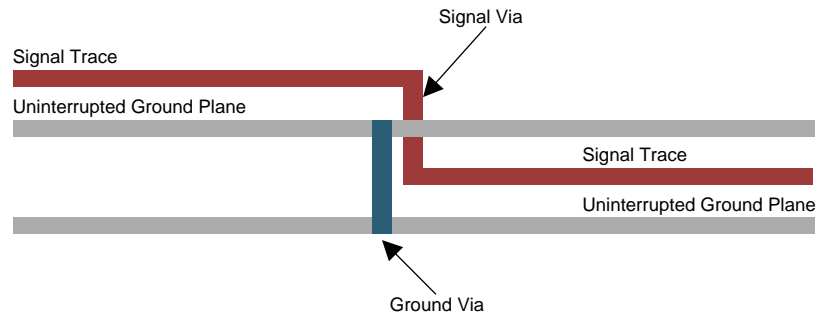

Figure 41. Ground Via Location (Side View)

Short and low-impedance connection of the device ground pins to the PCB ground plane reduces ground bounce. Holes and cutouts in the ground planes can adversely affect current return paths if they create discontinuities that increase returning current loop areas.

To minimize EMI problems, TI recommends avoiding discontinuities below a trace (for example, holes, slits, and so on) and keeping traces as short as possible. Zoning the board wisely by placing all similar functions in the same area, as opposed to mixing them together, helps reduce susceptibility issues.

13 Device and Documentation Support

13.1 Documentation Support

13.1.1 Related Documentation

For related documentation, see the following:

- *Introduction to M-LVDS (TIA/EIA-899)* ([SLLA108](#))
- *LVDS Application and Data Handbook* ([SLLD009](#))
- *LVDS Owner's Manual Design Guide, 4th Edition* ([SNLA187](#))
- *Semiconductor and IC Package Thermal Metrics* ([SPRA953](#))
- Howard Johnson and Martin Graham. 1993. *High Speed Digital Design – A Handbook of Black Magic*. Prentice Hall PRT. ISBN number 013395724.
- Mark I. Montrose. 1996. *Printed Circuit Board Design Techniques for EMC Compliance*. IEEE Press. ISBN number 0780311310.
- Clyde F. Coombs. 1995. *Printed Circuits Handbook*. McGraw Hill. ISBN number 0070127549.

13.2 Related Links

The table below lists quick access links. Categories include technical documents, support and community resources, tools and software, and quick access to sample or buy.

Table 8. Related Links

PARTS	PRODUCT FOLDER	SAMPLE & BUY	TECHNICAL DOCUMENTS	TOOLS & SOFTWARE	SUPPORT & COMMUNITY
SN65MLVD200A	Click here	Click here	Click here	Click here	Click here
SN65MLVD202A	Click here	Click here	Click here	Click here	Click here
SN65MLVD204A	Click here	Click here	Click here	Click here	Click here
SN65MLVD205A	Click here	Click here	Click here	Click here	Click here

13.3 Community Resources

The following links connect to TI community resources. Linked contents are provided "AS IS" by the respective contributors. They do not constitute TI specifications and do not necessarily reflect TI's views; see TI's [Terms of Use](#).

TI E2E™ Online Community *TI's Engineer-to-Engineer (E2E) Community*. Created to foster collaboration among engineers. At e2e.ti.com, you can ask questions, share knowledge, explore ideas and help solve problems with fellow engineers.

Design Support *TI's Design Support* Quickly find helpful E2E forums along with design support tools and contact information for technical support.

13.4 Trademarks

E2E is a trademark of Texas Instruments.

Rogers is a trademark of Rogers Corporation.

All other trademarks are the property of their respective owners.

13.5 Electrostatic Discharge Caution



These devices have limited built-in ESD protection. The leads should be shorted together or the device placed in conductive foam during storage or handling to prevent electrostatic damage to the MOS gates.

13.6 Glossary

SLYZ022 — *TI Glossary*.

This glossary lists and explains terms, acronyms, and definitions.

14 Mechanical, Packaging, and Orderable Information

The following pages include mechanical, packaging, and orderable information. This information is the most current data available for the designated devices. This data is subject to change without notice and revision of this document. For browser-based versions of this data sheet, refer to the left-hand navigation.

PACKAGING INFORMATION

Orderable Device	Status (1)	Package Type	Package Drawing	Pins	Package Qty	Eco Plan (2)	Lead/Ball Finish (6)	MSL Peak Temp (3)	Op Temp (°C)	Device Marking (4/5)	Samples
SN65MLVD200AD	ACTIVE	SOIC	D	8	75	Green (RoHS & no Sb/Br)	NIPDAU	Level-1-260C-UNLIM	-40 to 85	MF200A	Samples
SN65MLVD200ADG4	ACTIVE	SOIC	D	8	75	Green (RoHS & no Sb/Br)	NIPDAU	Level-1-260C-UNLIM	-40 to 85	MF200A	Samples
SN65MLVD200ADR	ACTIVE	SOIC	D	8	2500	Green (RoHS & no Sb/Br)	NIPDAU	Level-1-260C-UNLIM	-40 to 85	MF200A	Samples
SN65MLVD200ADRG4	ACTIVE	SOIC	D	8	2500	Green (RoHS & no Sb/Br)	NIPDAU	Level-1-260C-UNLIM	-40 to 85	MF200A	Samples
SN65MLVD202AD	ACTIVE	SOIC	D	14	50	Green (RoHS & no Sb/Br)	NIPDAU	Level-1-260C-UNLIM	-40 to 85	MLVD202A	Samples
SN65MLVD202ADR	ACTIVE	SOIC	D	14	2500	Green (RoHS & no Sb/Br)	NIPDAU	Level-1-260C-UNLIM	-40 to 85	MLVD202A	Samples
SN65MLVD204AD	ACTIVE	SOIC	D	8	75	Green (RoHS & no Sb/Br)	NIPDAU	Level-1-260C-UNLIM	-40 to 85	MF204A	Samples
SN65MLVD204ADG4	ACTIVE	SOIC	D	8	75	Green (RoHS & no Sb/Br)	NIPDAU	Level-1-260C-UNLIM	-40 to 85	MF204A	Samples
SN65MLVD204ADR	ACTIVE	SOIC	D	8	2500	Green (RoHS & no Sb/Br)	NIPDAU	Level-1-260C-UNLIM	-40 to 85	MF204A	Samples
SN65MLVD204ADRG4	ACTIVE	SOIC	D	8	2500	Green (RoHS & no Sb/Br)	NIPDAU	Level-1-260C-UNLIM	-40 to 85	MF204A	Samples
SN65MLVD205AD	ACTIVE	SOIC	D	14	50	Green (RoHS & no Sb/Br)	NIPDAU	Level-1-260C-UNLIM	-40 to 85	MLVD205A	Samples
SN65MLVD205ADG4	ACTIVE	SOIC	D	14	50	Green (RoHS & no Sb/Br)	NIPDAU	Level-1-260C-UNLIM	-40 to 85	MLVD205A	Samples
SN65MLVD205ADR	ACTIVE	SOIC	D	14	2500	Green (RoHS & no Sb/Br)	NIPDAU	Level-1-260C-UNLIM	-40 to 85	MLVD205A	Samples

(1) The marketing status values are defined as follows:

ACTIVE: Product device recommended for new designs.

LIFEBUY: TI has announced that the device will be discontinued, and a lifetime-buy period is in effect.

NRND: Not recommended for new designs. Device is in production to support existing customers, but TI does not recommend using this part in a new design.

PREVIEW: Device has been announced but is not in production. Samples may or may not be available.

OBSOLETE: TI has discontinued the production of the device.

(2) **RoHS:** TI defines "RoHS" to mean semiconductor products that are compliant with the current EU RoHS requirements for all 10 RoHS substances, including the requirement that RoHS substance do not exceed 0.1% by weight in homogeneous materials. Where designed to be soldered at high temperatures, "RoHS" products are suitable for use in specified lead-free processes. TI may reference these types of products as "Pb-Free".

RoHS Exempt: TI defines "RoHS Exempt" to mean products that contain lead but are compliant with EU RoHS pursuant to a specific EU RoHS exemption.

Green: TI defines "Green" to mean the content of Chlorine (Cl) and Bromine (Br) based flame retardants meet JS709B low halogen requirements of ≤ 1000 ppm threshold. Antimony trioxide based flame retardants must also meet the ≤ 1000 ppm threshold requirement.

(3) MSL, Peak Temp. - The Moisture Sensitivity Level rating according to the JEDEC industry standard classifications, and peak solder temperature.

(4) There may be additional marking, which relates to the logo, the lot trace code information, or the environmental category on the device.

(5) Multiple Device Markings will be inside parentheses. Only one Device Marking contained in parentheses and separated by a "~" will appear on a device. If a line is indented then it is a continuation of the previous line and the two combined represent the entire Device Marking for that device.

(6) Lead/Ball Finish - Orderable Devices may have multiple material finish options. Finish options are separated by a vertical ruled line. Lead/Ball Finish values may wrap to two lines if the finish value exceeds the maximum column width.

Important Information and Disclaimer: The information provided on this page represents TI's knowledge and belief as of the date that it is provided. TI bases its knowledge and belief on information provided by third parties, and makes no representation or warranty as to the accuracy of such information. Efforts are underway to better integrate information from third parties. TI has taken and continues to take reasonable steps to provide representative and accurate information but may not have conducted destructive testing or chemical analysis on incoming materials and chemicals. TI and TI suppliers consider certain information to be proprietary, and thus CAS numbers and other limited information may not be available for release.

In no event shall TI's liability arising out of such information exceed the total purchase price of the TI part(s) at issue in this document sold by TI to Customer on an annual basis.

TAPE AND REEL INFORMATION

QUADRANT ASSIGNMENTS FOR PIN 1 ORIENTATION IN TAPE

*All dimensions are nominal

Device	Package Type	Package Drawing	Pins	SPQ	Reel Diameter (mm)	Reel Width W1 (mm)	A0 (mm)	B0 (mm)	K0 (mm)	P1 (mm)	W (mm)	Pin1 Quadrant
SN65MLVD200ADR	SOIC	D	8	2500	330.0	12.4	6.4	5.2	2.1	8.0	12.0	Q1
SN65MLVD202ADR	SOIC	D	14	2500	330.0	16.4	6.5	9.0	2.1	8.0	16.0	Q1
SN65MLVD204ADR	SOIC	D	8	2500	330.0	12.4	6.4	5.2	2.1	8.0	12.0	Q1
SN65MLVD205ADR	SOIC	D	14	2500	330.0	16.4	6.5	9.0	2.1	8.0	16.0	Q1

TAPE AND REEL BOX DIMENSIONS

*All dimensions are nominal

Device	Package Type	Package Drawing	Pins	SPQ	Length (mm)	Width (mm)	Height (mm)
SN65MLVD200ADR	SOIC	D	8	2500	340.5	338.1	20.6
SN65MLVD202ADR	SOIC	D	14	2500	333.2	345.9	28.6
SN65MLVD204ADR	SOIC	D	8	2500	340.5	338.1	20.6
SN65MLVD205ADR	SOIC	D	14	2500	333.2	345.9	28.6

D (R-PDSO-G14)

PLASTIC SMALL OUTLINE



- NOTES:
- A. All linear dimensions are in inches (millimeters).
 - B. This drawing is subject to change without notice.
 - $\triangle C$ Body length does not include mold flash, protrusions, or gate burrs. Mold flash, protrusions, or gate burrs shall not exceed 0.006 (0,15) each side.
 - $\triangle D$ Body width does not include interlead flash. Interlead flash shall not exceed 0.017 (0,43) each side.
 - E. Reference JEDEC MS-012 variation AB.

D (R-PDSO-G14)

PLASTIC SMALL OUTLINE



- NOTES:
- All linear dimensions are in millimeters.
 - This drawing is subject to change without notice.
 - Publication IPC-7351 is recommended for alternate designs.
 - Laser cutting apertures with trapezoidal walls and also rounding corners will offer better paste release. Customers should contact their board assembly site for stencil design recommendations. Refer to IPC-7525 for other stencil recommendations.
 - Customers should contact their board fabrication site for solder mask tolerances between and around signal pads.



D0008A

PACKAGE OUTLINE

SOIC - 1.75 mm max height

SMALL OUTLINE INTEGRATED CIRCUIT



4214825/C 02/2019

NOTES:

1. Linear dimensions are in inches [millimeters]. Dimensions in parenthesis are for reference only. Controlling dimensions are in inches. Dimensioning and tolerancing per ASME Y14.5M.
2. This drawing is subject to change without notice.
3. This dimension does not include mold flash, protrusions, or gate burrs. Mold flash, protrusions, or gate burrs shall not exceed .006 [0.15] per side.
4. This dimension does not include interlead flash.
5. Reference JEDEC registration MS-012, variation AA.

EXAMPLE BOARD LAYOUT

D0008A

SOIC - 1.75 mm max height

SMALL OUTLINE INTEGRATED CIRCUIT



LAND PATTERN EXAMPLE
EXPOSED METAL SHOWN
SCALE:8X



SOLDER MASK DETAILS

4214825/C 02/2019

NOTES: (continued)

6. Publication IPC-7351 may have alternate designs.

7. Solder mask tolerances between and around signal pads can vary based on board fabrication site.

EXAMPLE STENCIL DESIGN

D0008A

SOIC - 1.75 mm max height

SMALL OUTLINE INTEGRATED CIRCUIT



SOLDER PASTE EXAMPLE
BASED ON .005 INCH [0.125 MM] THICK STENCIL
SCALE:8X

4214825/C 02/2019

NOTES: (continued)

8. Laser cutting apertures with trapezoidal walls and rounded corners may offer better paste release. IPC-7525 may have alternate design recommendations.
9. Board assembly site may have different recommendations for stencil design.

IMPORTANT NOTICE AND DISCLAIMER

TI PROVIDES TECHNICAL AND RELIABILITY DATA (INCLUDING DATASHEETS), DESIGN RESOURCES (INCLUDING REFERENCE DESIGNS), APPLICATION OR OTHER DESIGN ADVICE, WEB TOOLS, SAFETY INFORMATION, AND OTHER RESOURCES "AS IS" AND WITH ALL FAULTS, AND DISCLAIMS ALL WARRANTIES, EXPRESS AND IMPLIED, INCLUDING WITHOUT LIMITATION ANY IMPLIED WARRANTIES OF MERCHANTABILITY, FITNESS FOR A PARTICULAR PURPOSE OR NON-INFRINGEMENT OF THIRD PARTY INTELLECTUAL PROPERTY RIGHTS.

These resources are intended for skilled developers designing with TI products. You are solely responsible for (1) selecting the appropriate TI products for your application, (2) designing, validating and testing your application, and (3) ensuring your application meets applicable standards, and any other safety, security, or other requirements. These resources are subject to change without notice. TI grants you permission to use these resources only for development of an application that uses the TI products described in the resource. Other reproduction and display of these resources is prohibited. No license is granted to any other TI intellectual property right or to any third party intellectual property right. TI disclaims responsibility for, and you will fully indemnify TI and its representatives against, any claims, damages, costs, losses, and liabilities arising out of your use of these resources.

TI's products are provided subject to TI's Terms of Sale (www.ti.com/legal/termsofsale.html) or other applicable terms available either on ti.com or provided in conjunction with such TI products. TI's provision of these resources does not expand or otherwise alter TI's applicable warranties or warranty disclaimers for TI products.

Mailing Address: Texas Instruments, Post Office Box 655303, Dallas, Texas 75265
Copyright © 2020, Texas Instruments Incorporated