

Molded Parts Specification Control Drawing

Part Number : 462A421 thru 423
Description : Slimline Transition, 4 Entry

NOTES

- All dimensions are in $\frac{\text{inches}}{\text{[millimeters]}}$
- Dimensions appearing in table are as follows:
 - a - As Supplied
 - b - After Unrestricted Recovery
- Coating is optional. As supplied dimensions appearing in table are for uncoated parts. When coating is added, entry diameters will be reduced by .06 max.

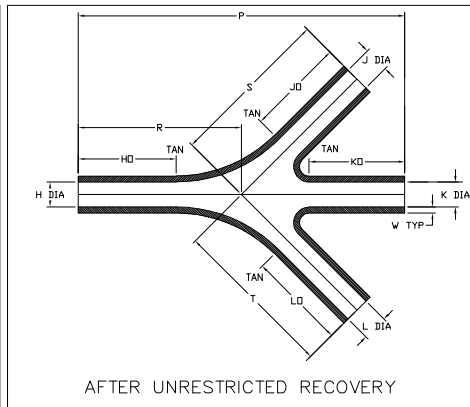
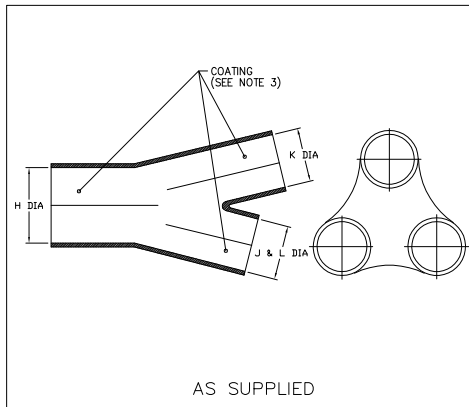

PART NUMBER	H		J,K & L		HO,JO,KO & LO ±15% b	W Nom b	P Nom b	R,S & T Nom b
	Min a	Max b	Min a	Max b				
462A421	.78 [19,8]	.26 [6,6]	.52 [13,2]	.26 [6,6]	1.00 [25,4]	.04 [1,0]	3.38 [85,9]	1.69 [42,9]
462A422	1.35 [34,3]	.45 [11,4]	.81 [20,6]	.45 [11,4]	1.62 [41,1]	.05 [1,3]	5.34 [135,6]	2.67 [67,8]
462A423	2.37 [60,2]	.79 [20,1]	1.42 [36,1]	.79 [20,1]	2.50 [63,5]	.06 [1,5]	8.16 [207,3]	4.08 [103,6]



Revision : U1
Date : 20APR11

Part Number : 462A421 thru 423
Description : Slimline Transition, 4 Entry

Molded Parts Specification Control Drawing

Part Number : 462A421 thru 423
Description : Slimline Transition, 4 Entry

MATERIAL DASH NO.	MATERIAL DESCRIPTION	RT SPEC	COATING SLASH NO.	COATING S NO.	COATING DESCRIPTION
-50	Flexible, VPB	RT-1313	N/A		
-51	Flexible, EPB	RT-1321	/164	S-1124	Adhesive
-71	Flexible, Polyolefin	RT-1316	/42,/86	S-1017,S-1048	Adhesive
-125	Modified Fluoropolymer	RT-1334	N/A		
-770	NBCCS	RT-770 TYPE II	N/A		
-780	NBCCS	RT-780 TYPE II	N/A		

ORDERING INFORMATION

462A4XX -XXX -XX /XXX -0

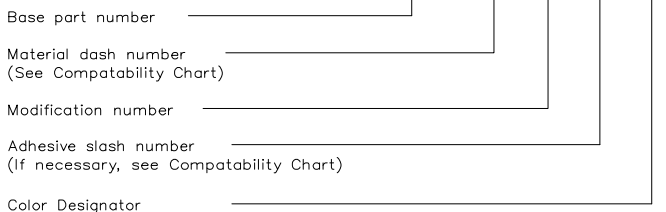

**IF THIS DOCUMENT IS PRINTED IT BECOMES UNCONTROLLED.
CHECK FOR THE LATEST REVISION.**

THIS DRAWING IS SUBJECT TO CHANGE WITHOUT NOTICE; CONSULT YOUR NEAREST FIELD REPRESENTATIVE FOR CURRENT REVISION



Revision : U1
Date : 20APR11

Part Number : 462A421 thru 423
Description : Slimline Transition, 4 Entry

Mouser Electronics

Authorized Distributor

Click to View Pricing, Inventory, Delivery & Lifecycle Information:

[TE Connectivity:](#)

[462A422-50-0](#)