

Slotted Optical Switch

Series: OPB355, OPB360, OPB370, OPB380
OPB859, OPB860, OPB870, OPB880, OPB890

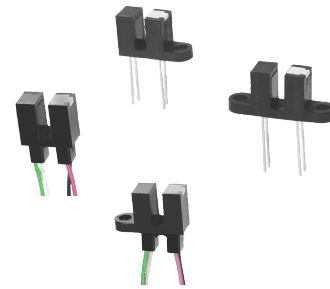

Features:

- 0.125" (3.175 mm) slot width
- Choice of aperture (0.050" or 0.010" width)
- Choice of opaque or IR transmissive shell material
- Choice of mounting configurations
- Choice of lead spacing or wires

Description:

The slotted optical sensors in this series provide the flexibility of a custom device from a standard product line.

Building from a standard housing with a 0.125" (3.18mm) wide slot, the user can specify output logic state, output driver circuit, aperture width, aperture surface and mounting tab locations. Furthermore, an option of wire or PCB leads allows electrical interface flexibility.

The device body is an opaque plastic which minimizes sensitivity to both visible and near-infrared external light sources which may impact operation. Aperture width choices provide different optical resolution for motion sensing. A covered aperture provides dust protection, while an open aperture provides maximum protection against external light sources.

Phototransistor sensor devices are: OPB360, OPB370, OPB380, OPB390, OPB859, OPB860, OPB870, OPB880, OPB890. The OPB355 provides a photodiode detector, which has a lower linear output-versus-light.

Wide electrical output current ranges are available. LED emissions are near-infrared (850-940nm).

Custom electrical, wire and cabling services are available.

Contact your local representative or OPTEK for more information. Compliant to EU RoHS Directive 2002/95/EC.

Applications:

- Non-contact object sensing
- Assembly line automation
- Machine automation
- Equipment safety
- Machine safety

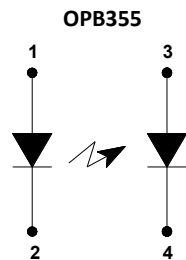

**OPB360, OPB370, OPB380, OPB390
OPB859
OPB860, OPB870, OPB880, OPB890**

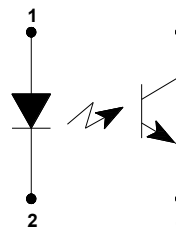

Wire Colors	
Color #	Description
1	Red
2	Black
3	White
4	Green

CONTAINS POLYSULFONE

To avoid stress cracking, we suggest using ND Industries' **Vibra-Tite** for thread-locking. **ND Vibra-Tite Formula 3** evaporates fast without causing structural failure in OPTEK's molded plastics.

**Applies to: OPB360, OPB370, OPB380, OPB390
and OPB860, OPB870, OPB880, OPB890.**



General Note

TT Electronics reserves the right to make changes in product specification without notice or liability. All information is subject to TT Electronics' own data and is considered accurate at time of going to print.

OPTEK Technology, Inc.
1645 Wallace Drive, Carrollton, TX 75006 | Ph: +1 972 323 2200
www.optekinc.com | www.ttelectronics.com

Slotted Optical Switch

Series: OPB355, OPB360, OPB370, OPB380

OPB859, OPB860, OPB870, OPB880, OPB890



Part Number Guide — OPB355

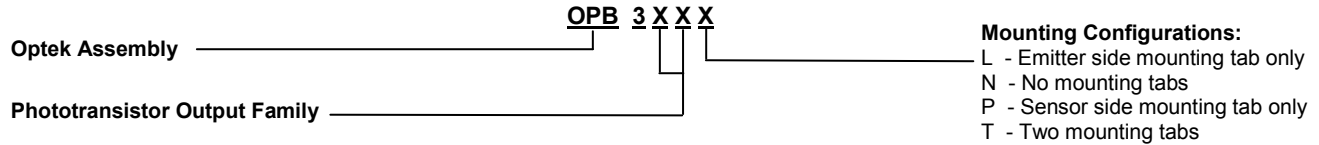

Part Number Guide — OPB360 / OPB370

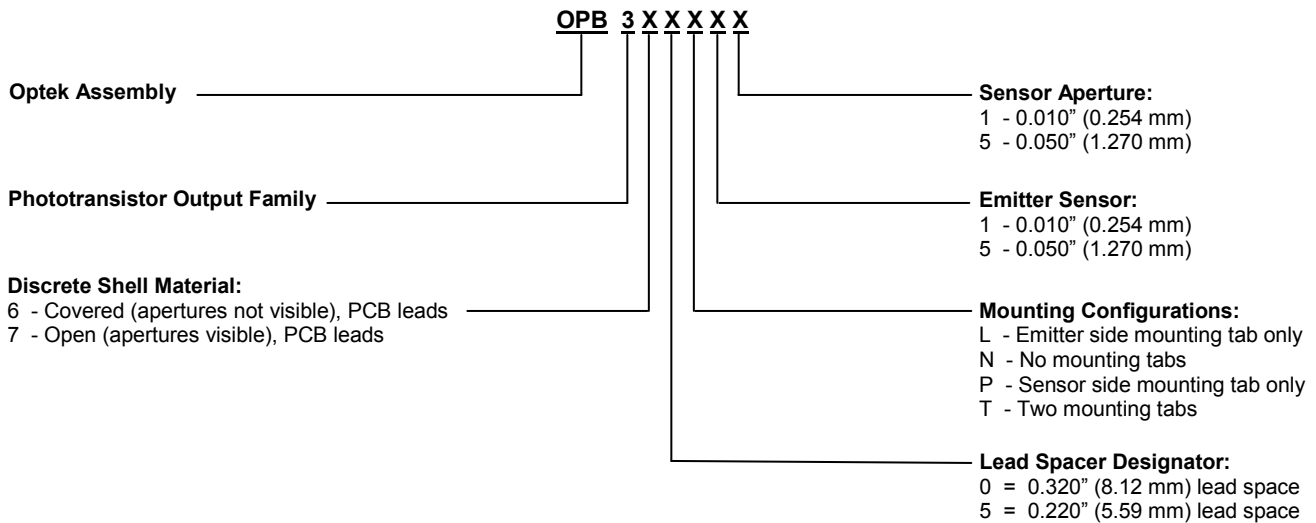

Part Number Guide — OPB380 / OPB390

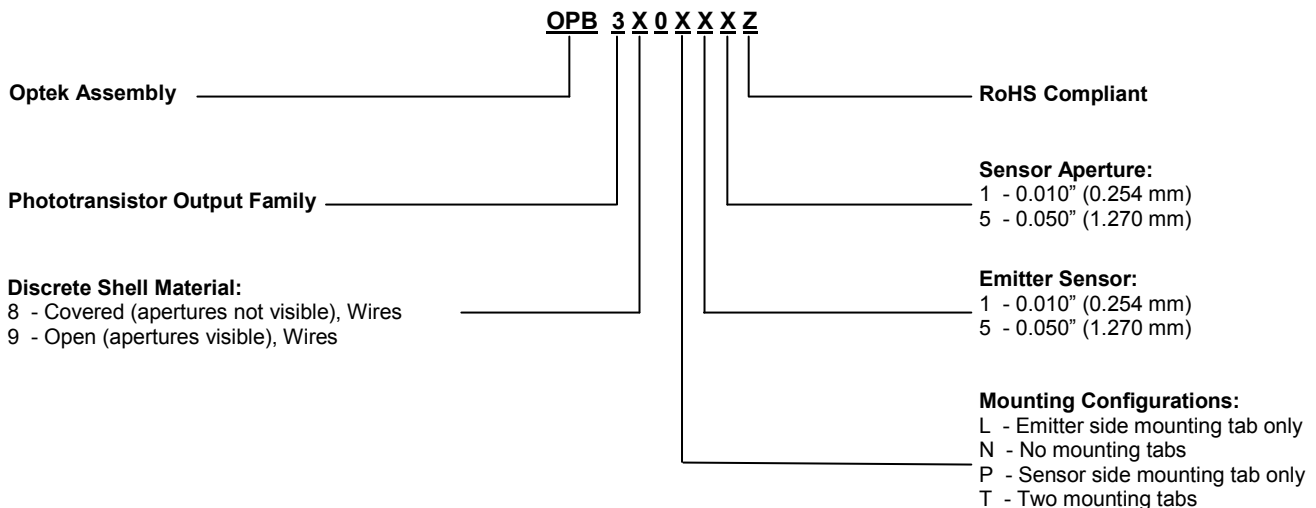

General Note
 TT Electronics reserves the right to make changes in product specification without notice or liability. All information is subject to TT Electronics' own data and is considered accurate at time of going to print.

OPTEK Technology, Inc.
 1645 Wallace Drive, Carrollton, TX 75006 | Ph: +1 972 323 2200
www.optekinc.com | www.ttelectronics.com

Slotted Optical Switch

Series: OPB355, OPB360, OPB370, OPB380

OPB859, OPB860, OPB870, OPB880, OPB890



Part Number Guide — OPB859

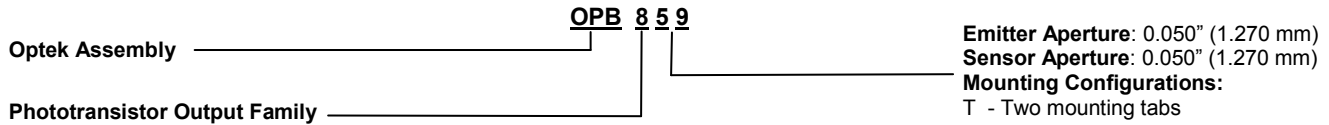

Part Number Guide — OPB860 / OPB870

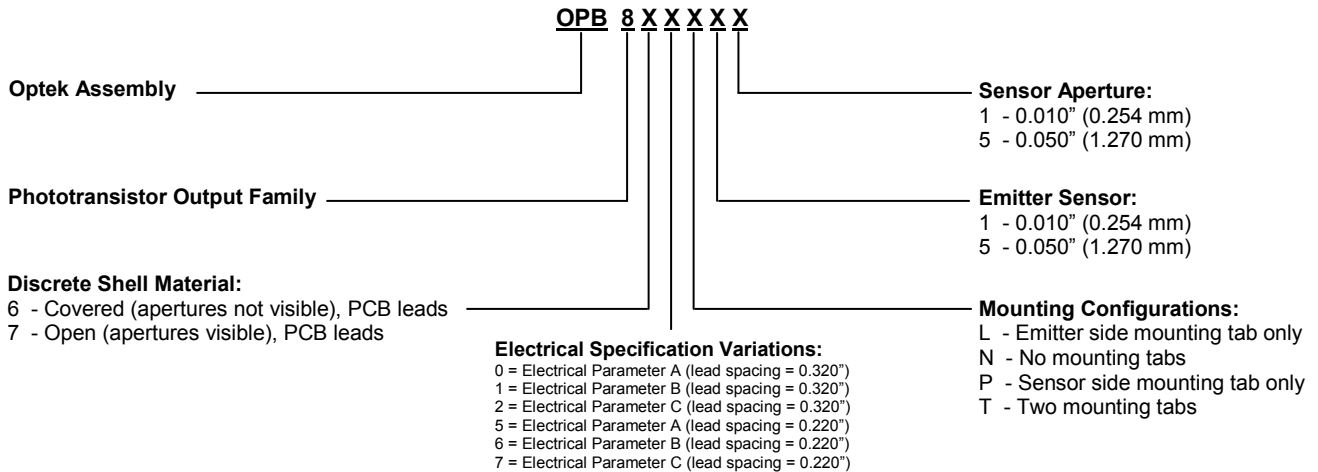

Note: Assemblies with dual 0.010" apertures are currently available with electrical parameter "A" only.

Part Number Guide — OPB880 / OPB890

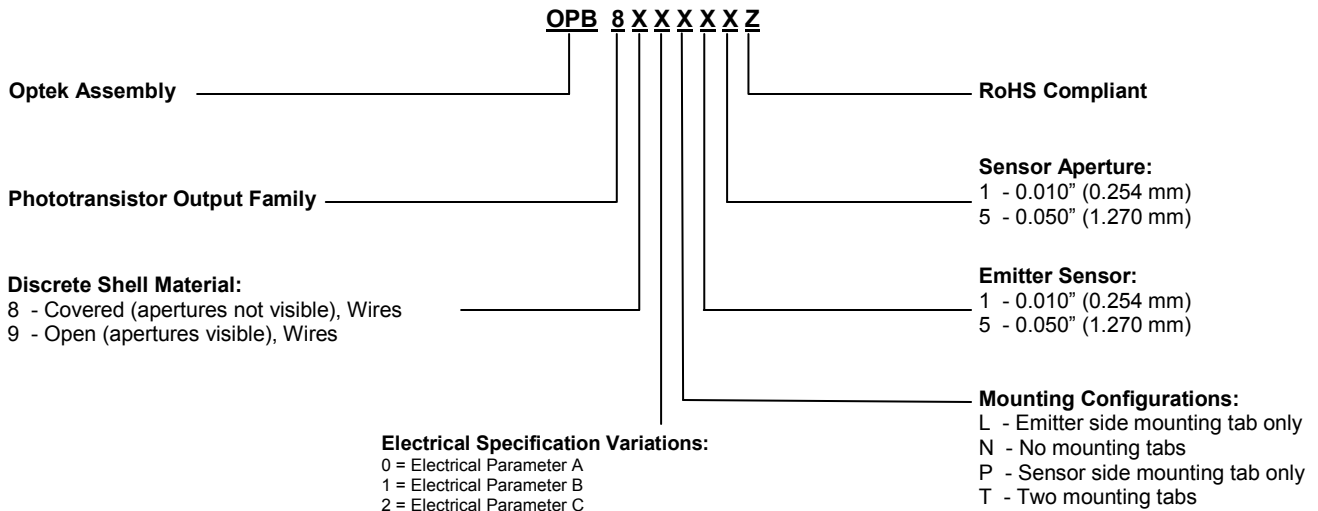

NOTE: Assemblies with dual 0.010" apertures are currently available with electrical parameter "A" only. Wires = 26AWG - 24" long. UL approved.

General Note

TT Electronics reserves the right to make changes in product specification without notice or liability. All information is subject to TT Electronics' own data and is considered accurate at time of going to print.

OPTEK Technology, Inc.
1645 Wallace Drive, Carrollton, TX 75006 | Ph: +1 972 323 2200
www.optekinc.com | www.ttelectronics.com

Slotted Optical Switch

Series: OPB355, OPB360, OPB370, OPB380

OPB859, OPB860, OPB870, OPB880, OPB890



OPB355, OPB360, OPB370

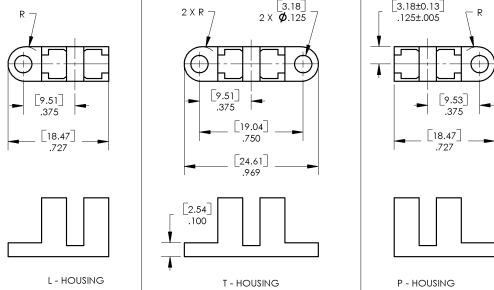
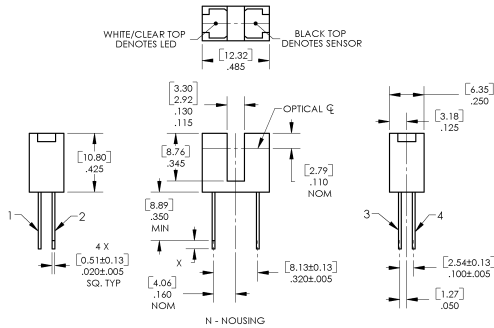

OPB380, OPB390

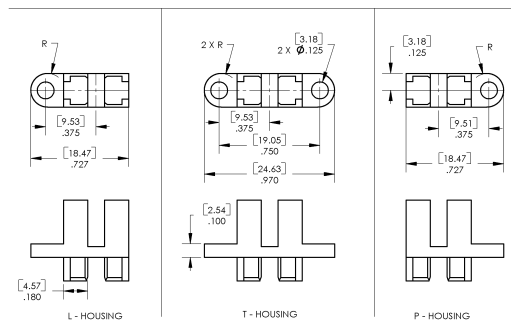
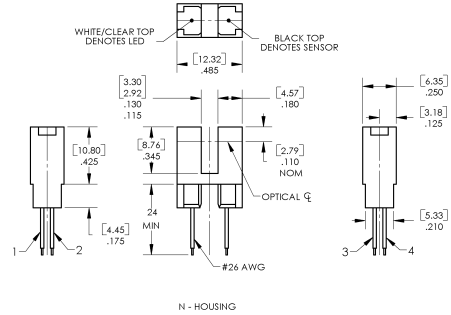

DIMENSIONS ARE IN INCHES AND MILLIMETERS
TOLERANCES ARE ± .010" [.25]

OPB859

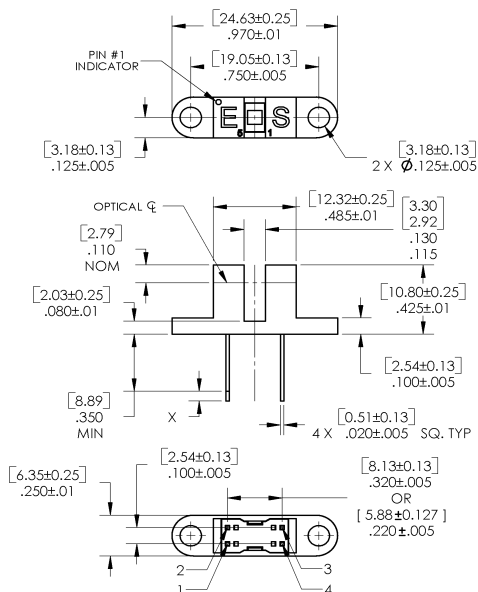

OPB880, OPB890

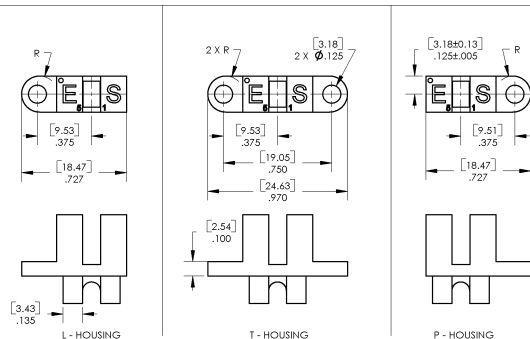
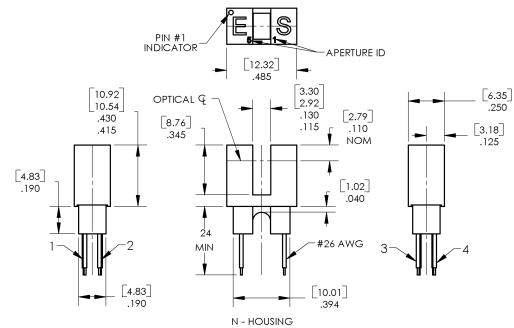

DIMENSIONS ARE IN: [MILLIMETERS]
INCHES

Pin #	Emitter	Pin #	Transistor/Diode
1	Anode	3	Collector / Anode
2	Cathode	4	Emitter / Cathode

General Note

TT Electronics reserves the right to make changes in product specification without notice or liability. All information is subject to TT Electronics' own data and is considered accurate at time of going to print.

Slotted Optical Switch

Series: OPB355, OPB360, OPB370, OPB380
 OPB859, OPB860, OPB870, OPB880, OPB890



OPB860, OPB870

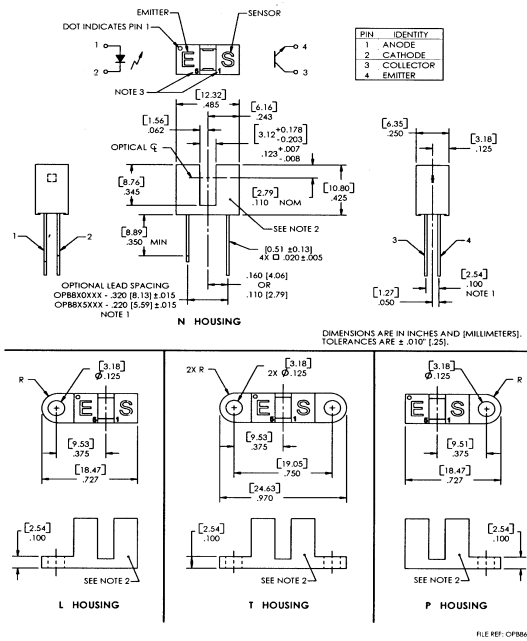

General Note

TT Electronics reserves the right to make changes in product specification without notice or liability. All information is subject to TT Electronics' own data and is considered accurate at time of going to print.

OPTEK Technology, Inc.
 1645 Wallace Drive, Carrollton, TX 75006 | Ph: +1 972 323 2200
 www.optekinc.com | www.ttelectronics.com

Slotted Optical Switch

Series: OPB355, OPB360, OPB370, OPB380
OPB859, OPB860, OPB870, OPB880, OPB890



Absolute Maximum Ratings ($T_A = 25^\circ\text{C}$ unless otherwise noted)	
Storage Temperature ^{(1) (2)} OPB355, OPB360, OPB370, OPB859, OPB860, OPB870 Series OPB380, OPB390, OPB880, OPB890 Series	-40° C to +100° C -40° C to +85° C
Operating Temperature ^{(1) (2)}	-40° C to +85° C
Lead Soldering Temperature ⁽⁷⁾	260° C
Input LED	
Forward DC Current OPB355, OPB360, OPB370, OPB380, OPB390, OPB859, OPB860, OPB870, OPB880, OPB890	50 mA
Peak Forward Current (1 μs pulse width, 300 pps)	1 A
Reverse DC Voltage	2 V
Power Dissipation ⁽²⁾	75 mW
Output Phototransistor/Diode	
Cathode-Anode Reverse Voltage -OPB355	60 V
Collector-Emitter Voltage OPB360, OPB370, OPB380, OPB390, OPB859, OPB860, OPB870, OPB880, OPB890 Series	30 V
Emitter-Collector Voltage	5 V
Collector DC Current	30 mA
Power Dissipation ⁽¹⁾	100 mW

Notes:

- (1) For wire series (OPB380, OPB390, OPB880 and OPB890), maximum storage and operating temperature is limited by the temperature rating of the lead wires.
- (2) Derate linearly 1.67 mW/° C above 25° C.
- (3) For OPB355, OPB360 and OPB370, polarity is denoted by color of housing top: LED (clear); sensor (black).
- (4) Cleaning agents methanol and isopropanol are recommended. Spray or wipe; do not submerge.
- (5) OPB380 and OPB390 wire terminations have 24" of 7-strand 26 AWG UL approved insulated wire on each terminal. These devices incorporate a wire strain relief at the housing surface. The insulation colors and functions are: IRED anode (red); IRED cathode (black); phototransistor collector (white); phototransistor emitter (green).
- (6) RMA flux is recommended. Duration can be extended to 10 seconds maximum when flow soldering.
- (7) All parameters were tested using pulse technique.

General Note

TT Electronics reserves the right to make changes in product specification without notice or liability. All information is subject to TT Electronics' own data and is considered accurate at time of going to print.

OPTEK Technology, Inc.
1645 Wallace Drive, Carrollton, TX 75006 | Ph: +1 972 323 2200
www.optekinc.com | www.ttelectronics.com

Slotted Optical Switch

Series: OPB355, OPB360, OPB370, OPB380

OPB859, OPB860, OPB870, OPB880, OPB890



Electrical Characteristics (T _A = 25° C unless otherwise noted)						
SYMBOL	PARAMETER	MIN	TYP	MAX	UNITS	TEST CONDITIONS
Input Transistor/Diode (See OP240 for additional information—for reference only)						
V _F	Forward Voltage	-	1.3	1.8	V	I _F = 20 mA
I _R	Reverse Current	-	-	100	μA	V _R = 2 V
Output Diode — OPB355 (See OPB950 for additional information — for reference only)						
V _{BR}	Reverse Diode Breakdown Voltage	60	-	-	V	I _R = 100 μA, I _F = 0, E _E = 0
V _{FD}	Forward Voltage Photodiode	-	-	1.2	V	I _F = 1 mA, I _F = 0, E _E = 0
ID	Reverse Dark Current	-	-	60	nA	V _R = 30 V, E _E = 0, I _F = 0
Output Transistor (See OP550 for additional information—for reference only)						
V _{(BR)CEO}	Collector-Emitter Breakdown Voltage	30	-	-	V	I _C = 1 mA
V _{(BR)ECO}	Emitter-Collector Breakdown Voltage	5	-	-	V	I _E = 100 μA
I _{CEO}	Collector-Emitter Dark Current	-	-	100	nA	V _{CE} = 10 V, I _F = 0, E _E = 0
Coupled						
I _L	On-State Collector Current OPB355 (L, N, P, T)	10	-	200	μa	V _R = 5 V, I _F = 40 mA
V _{CE(SAT)}	Collector-Emitter Saturation Voltage OPB859 OPB860/870/865/875 (Para. A) OPB861/871/866/876 (Para. B) OPB862/872/867/877 (Para. C) OPB880/890/ (Para. A) OPB881/891 (Para. B) OPB882/892 (Para. C)	- - - - - - -	- - - - - - -	0.4 0.4 0.4 0.6 0.4 0.4 0.6	V	I _C = 125 μA, I _F = 20 mA I _C = 400 μA, I _F = 20 mA I _C = 800 μA, I _F = 20 mA I _C = 1800 μA, I _F = 20 mA I _C = 400 μA, I _F = 20 mA I _C = 800 μA, I _F = 10 mA I _C = 1800 μA, I _F = 20 mA
I _{C(ON)}	On-State Collector Current OPB36X, OPB37X (T, N, L, P 11) OPB36X, OPB37X (T, N, L, P 51) OPB36X, OPB37X (T, N, L, P 55) OPB38X, OPB39X (T, N, L, P 11) OPB38X, OPB39X (T, N, L, P 51) OPB38X, OPB39X (T, N, L, P 55)	1.0 2.5 3.5 1.0 2.5 3.5	- - - - - -	5 10 14 5 10 14	mA	V _{CE} = 0.4 V, I _F = 20 mA
	OPB859	250	-	-	μA	V _{CE} = 10 V, I _F = 20 mA
	OPB860/870/865/875 (Para. A) OPB861/871/866/876 (Para. B) OPB862/872/867/877 (Para. C) OPB880/890/ (Para. A) OPB881/891 (Para. B) OPB882/892 (Para. C)	0.5 1.0 1.8 0.5 1.0 1.8	- - - - - -	- - - - - -	mA	V _{CE} = 10 V, I _F = 20 mA V _{CE} = 5 V, I _F = 10 mA V _{CE} = 0.6 V, I _F = 20 mA V _{CE} = 10 V, I _F = 20 mA V _{CE} = 5 V, I _F = 10 mA V _{CE} = 0.6 V, I _F = 20 mA

General Note

TT Electronics reserves the right to make changes in product specification without notice or liability. All information is subject to TT Electronics' own data and is considered accurate at time of going to print.

OPTEK Technology, Inc.
1645 Wallace Drive, Carrollton, TX 75006 | Ph: +1 972 323 2200
www.optekinc.com | www.ttelectronics.com

Slotted Optical Switch

Series: OPB355, OPB360, OPB370, OPB380

OPB859, OPB860, OPB870, OPB880, OPB890



OPB355 - Flag Next to Emitter

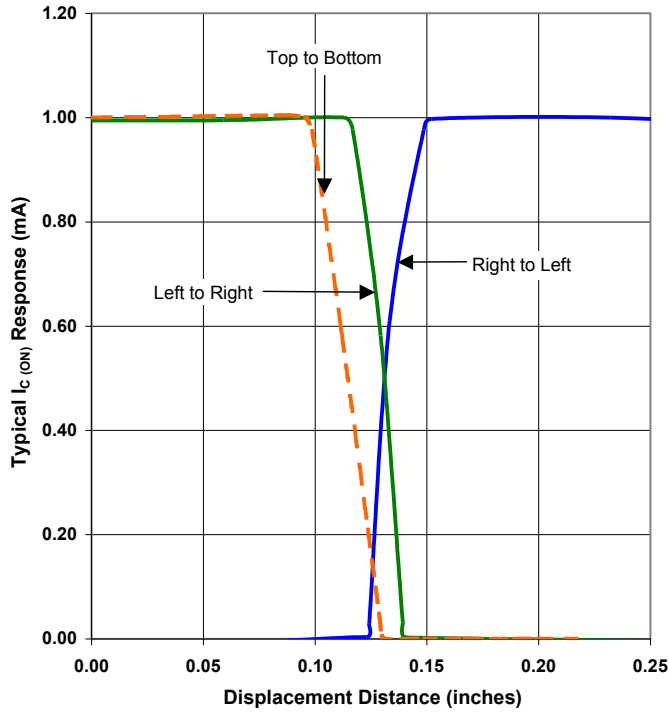

OPB355 - Flag Next to Sensor

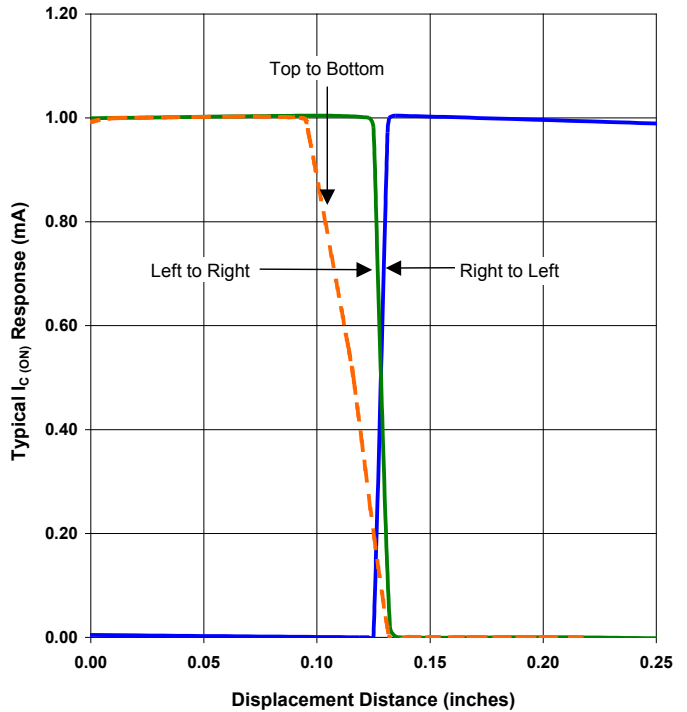

OPB355 - Flag in Middle of Slot

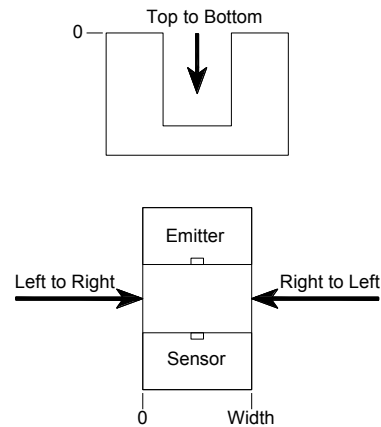
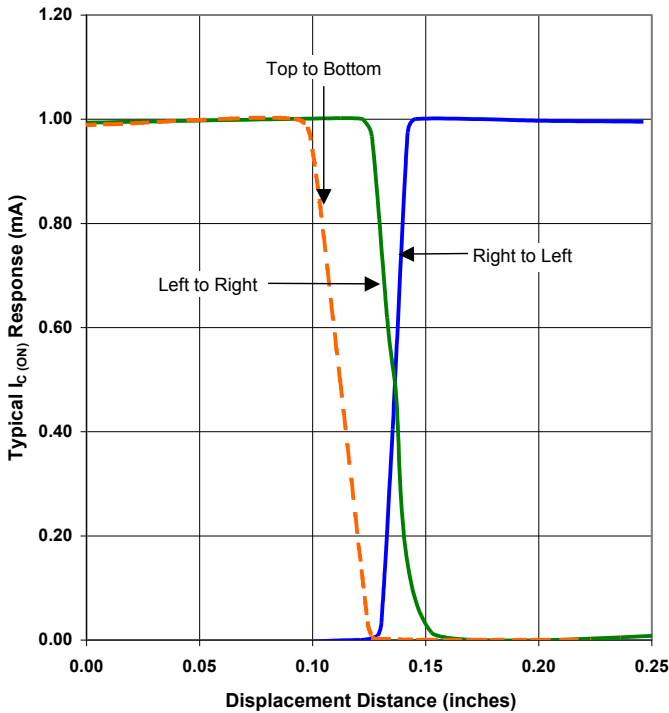

General Note
 TT Electronics reserves the right to make changes in product specification without notice or liability. All information is subject to TT Electronics' own data and is considered accurate at time of going to print.

OPTEK Technology, Inc.
 1645 Wallace Drive, Carrollton, TX 75006 | Ph: +1 972 323 2200
www.optekinc.com | www.ttelectronics.com

Slotted Optical Switch

Series: OPB355, OPB360, OPB370, OPB380

OPB859, OPB860, OPB870, OPB880, OPB890



Aperture Configuration 11 - Flag Next to Emitter

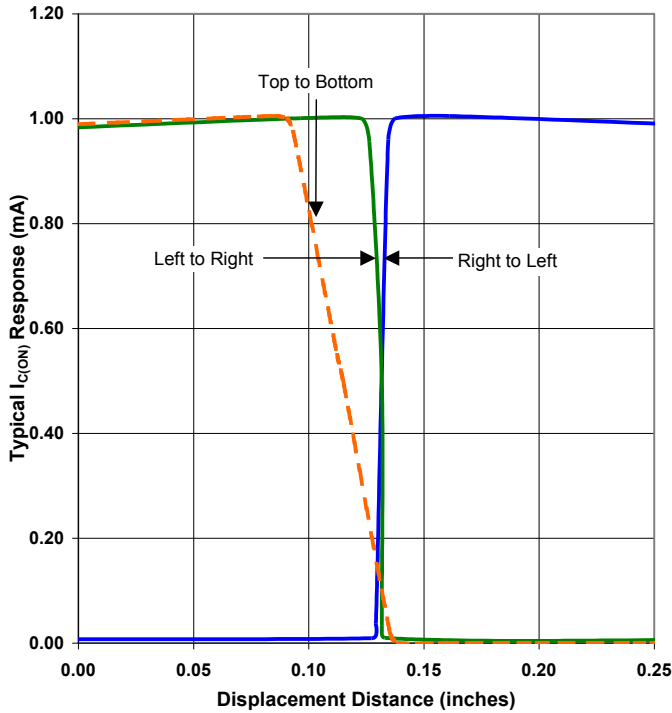

Aperture Configuration 11 - Flag Next to Sensor

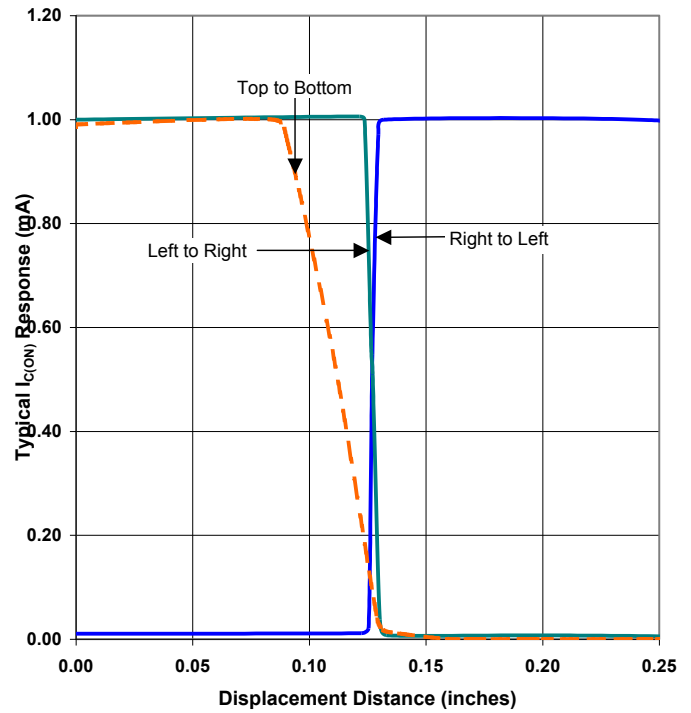

Aperture Configuration 11 - Flag in Middle of Slot

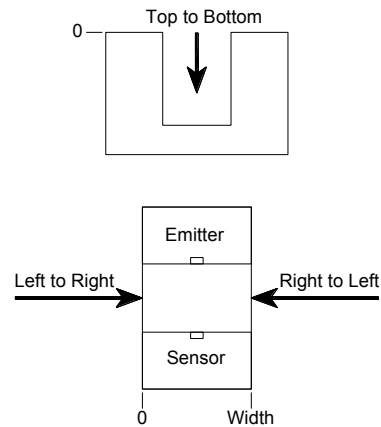
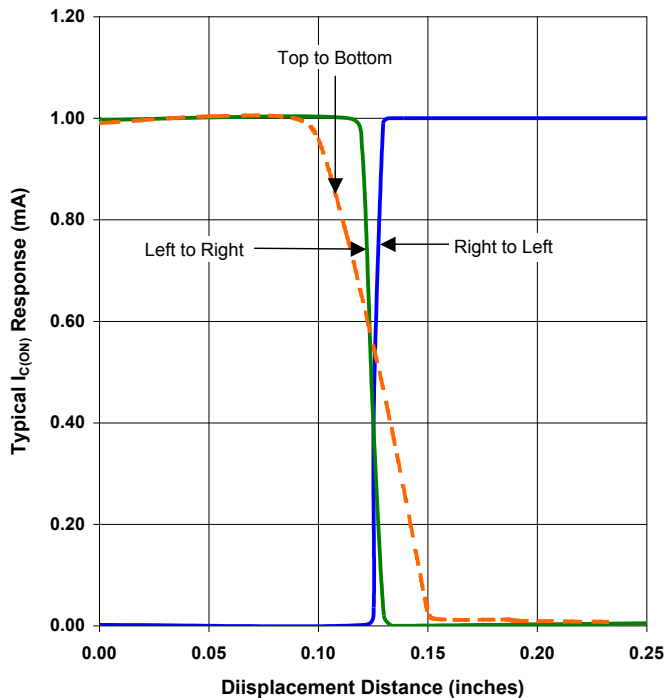

General Note
TT Electronics reserves the right to make changes in product specification without notice or liability. All information is subject to TT Electronics' own data and is considered accurate at time of going to print.

OPTEK Technology, Inc.
1645 Wallace Drive, Carrollton, TX 75006 | Ph: +1 972 323 2200
www.optekinc.com | www.ttelectronics.com

Slotted Optical Switch

Series: OPB355, OPB360, OPB370, OPB380

OPB859, OPB860, OPB870, OPB880, OPB890



Aperture Configuration 51 - Flag Next to Emitter

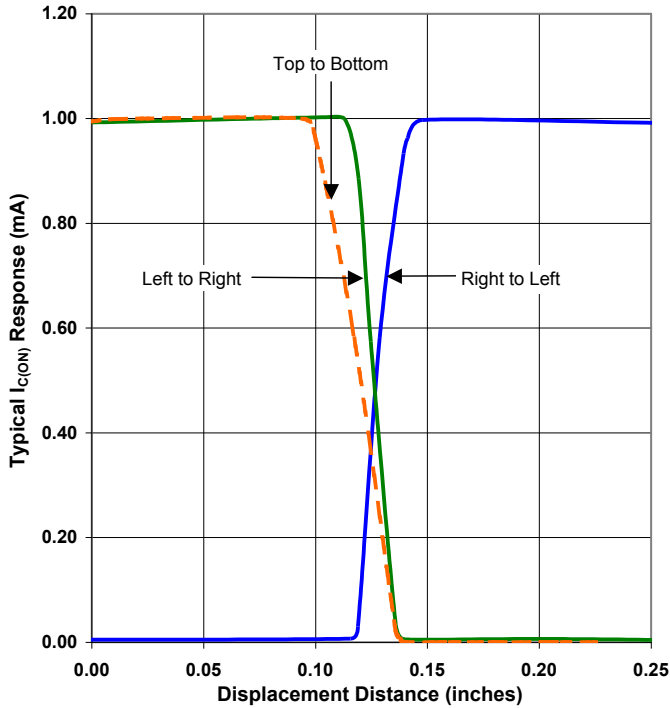

Aperture Configuration 51 - Flag Next to Sensor

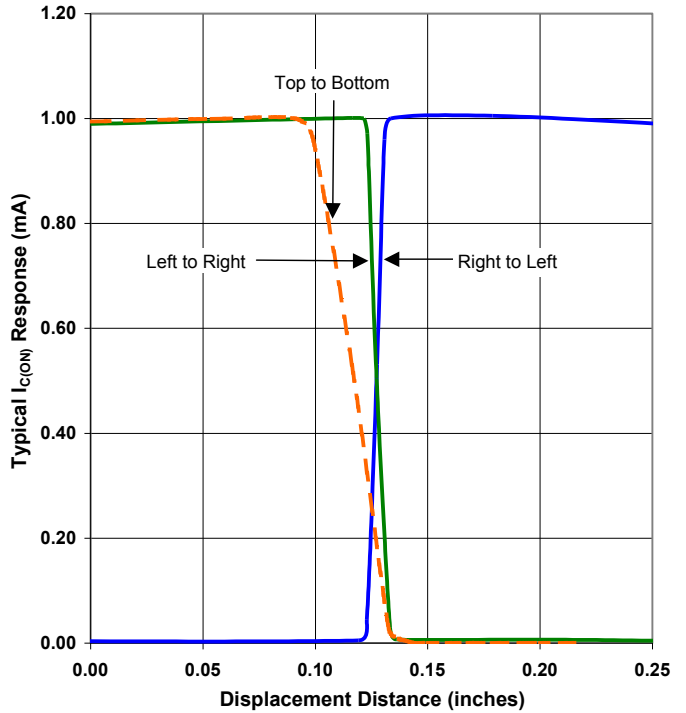

Aperture Configuration 51 - Flag in Middle of Slot

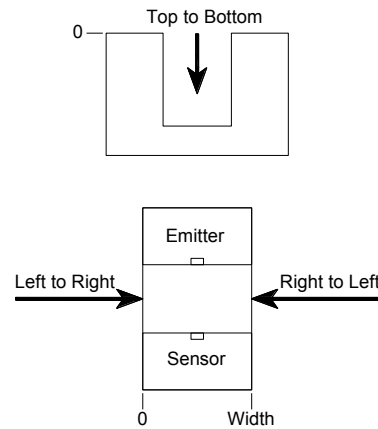
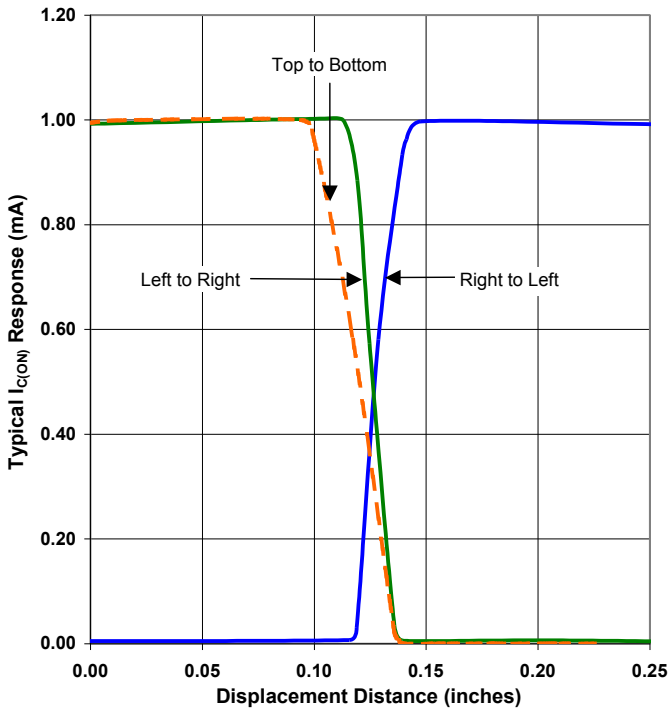

General Note

TT Electronics reserves the right to make changes in product specification without notice or liability. All information is subject to TT Electronics' own data and is considered accurate at time of going to print.

OPTEK Technology, Inc.
1645 Wallace Drive, Carrollton, TX 75006 | Ph: +1 972 323 2200
www.optekinc.com | www.ttelectronics.com

Slotted Optical Switch

Series: OPB355, OPB360, OPB370, OPB380

OPB859, OPB860, OPB870, OPB880, OPB890



Aperture Configuration 55 - Flag Next to Emitter

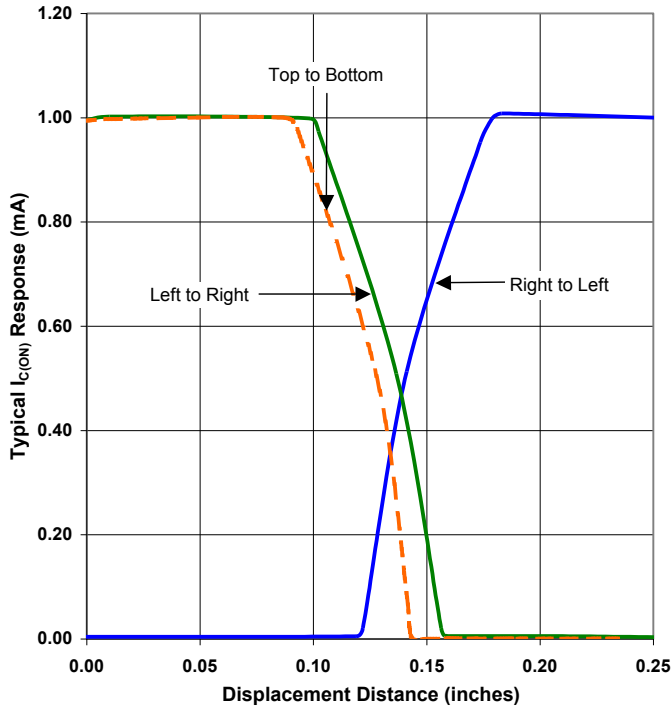

Aperture Configuration 55 - Flag Next to Sensor

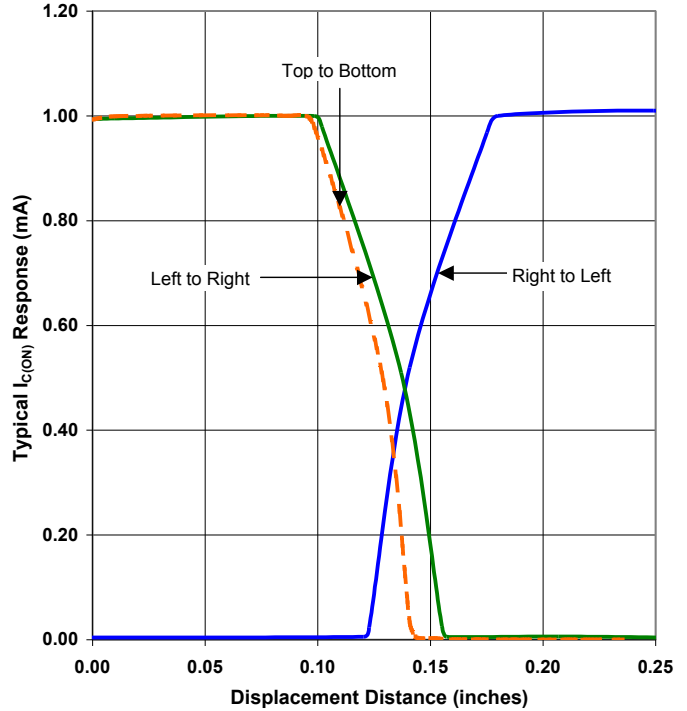

Aperture Configuration 55 - Flag in Middle of Slot

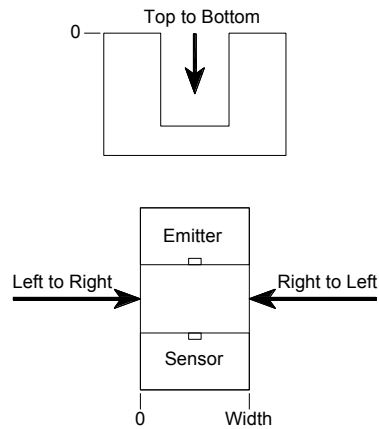
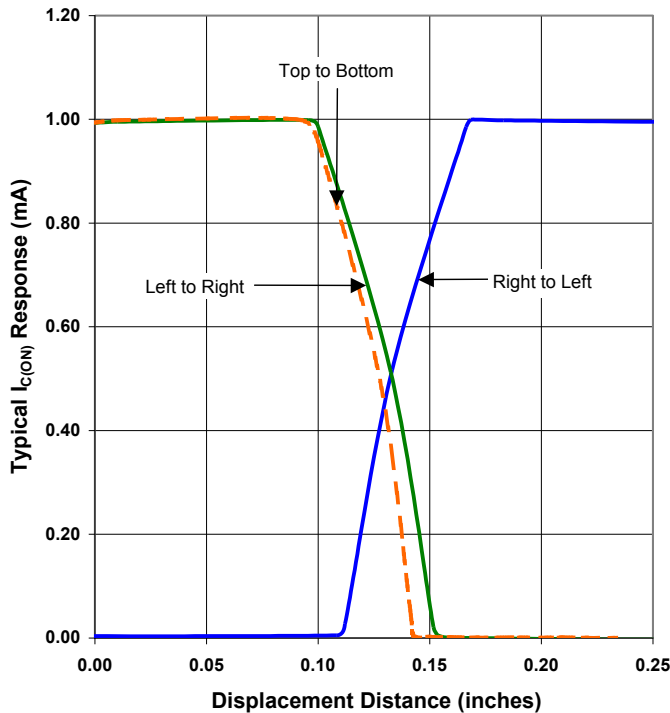

General Note

TT Electronics reserves the right to make changes in product specification without notice or liability. All information is subject to TT Electronics' own data and is considered accurate at time of going to print.

OPTEK Technology, Inc.
1645 Wallace Drive, Carrollton, TX 75006 | Ph: +1 972 323 2200
www.optekinc.com | www.ttelectronics.com

Mouser Electronics

Authorized Distributor

Click to View Pricing, Inventory, Delivery & Lifecycle Information:

TT Electronics:

[OPB890T51](#) [OPB380T51](#) [OPB380T55](#) [OPB390L11](#) [OPB390L51](#) [OPB390L55](#) [OPB390N11](#) [OPB390N51](#)
[OPB390N55](#) [OPB390P11](#) [OPB390P51](#) [OPB390P55](#) [OPB390T11](#) [OPB390T51](#) [OPB390T55](#) [OPB880T11](#)
[OPB380L11Z](#) [OPB380L51Z](#) [OPB380L55Z](#) [OPB380N11Z](#) [OPB380N51Z](#) [OPB380N55Z](#) [OPB380P11Z](#) [OPB380P51Z](#)
[OPB380P55Z](#) [OPB380T11Z](#) [OPB380T51Z](#) [OPB380T55Z](#) [OPB390L11Z](#) [OPB390L51Z](#) [OPB390L55Z](#)
[OPB390N11Z](#) [OPB390N51Z](#) [OPB390N55Z](#) [OPB390P11Z](#) [OPB390P51Z](#) [OPB390P55Z](#) [OPB390T11Z](#)
[OPB390T51Z](#) [OPB390T55Z](#) [OPB880L11Z](#) [OPB880L51Z](#) [OPB880L55Z](#) [OPB880N11Z](#) [OPB880N51Z](#) [OPB880N55Z](#)
[OPB880P11Z](#) [OPB880P51Z](#) [OPB880P55Z](#) [OPB880T11Z](#) [OPB880T55Z](#) [OPB881L51Z](#) [OPB881L55Z](#)
[OPB881N51Z](#) [OPB881N55Z](#) [OPB881P51Z](#) [OPB881P55Z](#) [OPB881T51Z](#) [OPB881T55Z](#) [OPB882L51Z](#) [OPB882L55Z](#)
[OPB882N51Z](#) [OPB882N55Z](#) [OPB882P51Z](#) [OPB882P55Z](#) [OPB882T51Z](#) [OPB882T55Z](#) [OPB890L11Z](#)
[OPB890L51Z](#) [OPB890L55Z](#) [OPB890N11Z](#) [OPB890N51Z](#) [OPB890N55Z](#) [OPB890P11Z](#) [OPB890P51Z](#) [OPB890P55Z](#)
[OPB890T11Z](#) [OPB890T51Z](#) [OPB890T55Z](#) [OPB891L51Z](#) [OPB891L55Z](#) [OPB891N51Z](#) [OPB891N55Z](#)
[OPB891P51Z](#) [OPB891P55Z](#) [OPB891T51Z](#) [OPB891T55Z](#) [OPB892L51Z](#) [OPB892L55Z](#) [OPB892N51Z](#) [OPB892N55Z](#)
[OPB892P51Z](#) [OPB892P55Z](#) [OPB892T51Z](#) [OPB892T55Z](#) [OPB865P11](#) [OPB891T55](#) [OPB885Z](#) [OPB370N55](#)
[OPB355L](#)