

Multi-stage Performance AC/DC EMI Filter



- Rated currents from 1 to 36 A
- High differential and common-mode attenuation
- High frequency attenuation
- Optional medical versions (B type)
- Optional safety versions (A type)



Technical specifications

Rated voltage*	250 VAC, 50/60 Hz; 250 VDC
Operating frequency	DC to 400 Hz
Rated currents	1 to 36 A @ 40°C max.
High potential test voltage	P → PE 2000 VAC for 2 sec P → PE 2500 VAC for 2 sec (B types) P → N 1100 VDC for 2 sec
Temperature range (operation and storage)	-25°C to +100°C (25/100/21)**
Certified to	UL 1283, CSA 22.2 No. 8 1986, IEC/EN 60939 (applies to AC and DC applications)
Flammability corresponding to	Terminal plastic for -06/-08 version: UL 94 V-0 Laces for -07 version: UL 94 VW-1 Grommet for -07 version: UL 94V-0
Design corresponding to	UL 1283, CSA 22.2 No. 8 1986, IEC/EN 60939
Overvoltage category	II acc. IEC 60664-1
Pollution degree	2 acc. IEC 60664-1
Altitude	2000m (above derating applies)**
MTBF @ 40°C/230 V (Mil-HB-217F)	1,550,000 hours 1,600,000 hours (B types)

* maximum RMS operating voltage at rated frequency or the maximum DC operating voltage

** for dedicated requests exceeding this specification (e.g. -40 °C or higher altitude) please contact your local Schaffner Sales office

Approvals



Features and benefits

- FN 2070 two-stage filters are designed for easy and fast chassis mounting
- FN 2070 B versions without capacitors to earth comply to 1MOP for ME (medical equipment) acc. IEC 60601-1
- FN 2070 A version with low capacitance to earth for safety critical applications with necessity for low leakage currents
- All filters provide a high conducted attenuation performance, based on chokes with high saturation resistance and excellent thermal behavior
- FN 2070 two-stage filters are designed for high frequency attenuation
- FN 2070 filters are also available as single-stage filters (FN 2030 series)
- FN 2070 filters are also available with differential mode choke (FN 2080 series)
- Various terminal options allow you to select the desired connection style



Typical applications

- Electrical and electronic equipment
- Consumer goods
- Household equipment
- Building automation
- Industrial applications
- Machinery
- Medical equipment
- Electronic data processing equipment
- Office automation and datacom equipment
- Various noisy applications requiring good filter performance
- Single Phase Motor Drives

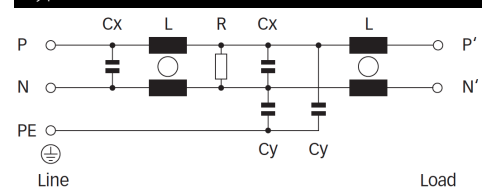
Typical electrical schematic



Filter selection table

Filter*	Rated current @ 40°C (25°C)	Leakage current** @ 250 VAC/50 Hz (@ 120 VAC/60 Hz)	Inductance*** L	Capacitance***		Resistance*** R	Input/Output connections			Weight [g]
				Cx	Cy					
	[A]	[mA]	[mH]	[μF]	[nF]	[kΩ]				
FN 2070-1-..	1 (1.2)	0.66 (0.38)	22	0.33	4.7	1000	-06	-07		190
FN 2070-3-..	3 (3.5)	0.66 (0.38)	9.8	0.47	4.7	470	-06	-07		250
FN 2070-6-..	6 (6.9)	0.66 (0.38)	7.8	1	4.7	220	-06	-07		450
FN 2070-10-..	10 (11.5)	0.66 (0.38)	4.5	1	4.7	220	-06	-07	-08	670
FN 2070-12-..	12 (13.8)	0.66 (0.38)	3.25	1	4.7	220	-06	-07	-08	670
FN 2070-16-..	16 (18.4)	0.66 (0.38)	2.8	1	4.7	220	-06	-07	-08	1000
FN 2070-25-08	25 (28.8)	0.66 (0.38)	2	2.2	4.7	220			-08	760
FN 2070-36-08	36 (41.4)	0.66 (0.38)	1.23	2.2	4.7	220			-08	790
FN 2070 A-1-..	1 (1.2)	0.07 (0.04)	22	0.33	0.47	1000	-06	-07		190
FN 2070 A-3-..	3 (3.5)	0.07 (0.04)	9.8	0.47	0.47	470	-06	-07		250
FN 2070 A-6-..	6 (6.9)	0.07 (0.04)	7.8	1	0.47	220	-06	-07		450
FN 2070 A-10-..	10 (11.5)	0.07 (0.04)	4.5	1	0.47	220	-06	-07	-08	670
FN 2070 A-12-..	12 (13.8)	0.07 (0.04)	3.25	1	0.47	220	-06	-07	-08	670
FN 2070 A-16-..	16 (18.4)	0.07 (0.04)	2.8	1	0.47	220	-06	-07	-08	1000
FN 2070 A-25-08	25 (28.8)	0.07 (0.04)	2	2.2	0.47	220			-08	760
FN 2070 A-36-08	36 (41.4)	0.07 (0.04)	1.23	2.2	0.47	220			-08	790
FN 2070 B-1-..	1 (1.2)	0.00	22	0.33		1000	-06	-07		190
FN 2070 B-3-..	3 (3.5)	0.00	9.8	0.47		470	-06	-07		250
FN 2070 B-6-..	6 (6.9)	0.00	7.8	1		220	-06	-07		450
FN 2070 B-10-..	10 (11.5)	0.00	4.5	1		220	-06	-07	-08	670
FN 2070 B-12-..	12 (13.8)	0.00	3.25	1		220	-06	-07	-08	670
FN 2070 B-16-..	16 (18.4)	0.00	2.8	1		220	-06	-07	-08	1000
FN 2070 B-25-08	25 (28.8)	0.00	2	2.2		220			-08	760
FN 2070 B-36-08	36 (41.4)	0.00	1.23	2.2		220			-08	790
Enhanced performance										
FN 2070 M-1-06	1 (1.2)	3.69 (2.13)	22	0.33	47	1000	-06			170
FN 2070 M-3-06	3 (3.5)	3.69 (2.13)	9.8	0.47	47	470	-06			250
FN 2070 M-6-06	6 (6.9)	3.69 (2.13)	7.8	1	47	220	-06			450
FN 2070 M-10-06	10 (11.5)	3.69 (2.13)	4.5	1	47	220	-06		-08	670
FN 2070 M-12-06	12 (13.8)	3.69 (2.13)	3.25	1	47	220	-06		-08	670
FN 2070 M-16-..	16 (18.4)	3.69 (2.13)	2.8	1	47	220	-06		-08	1000
FN 2070 M-25-08	25 (28.8)	3.69 (2.13)	2	2.2	47	220			-08	750
FN 2070 L-36-08	36 (41.4)	2.59 (1.49)	1.23	2.2	33	220			-08	790

* To compile a complete part number, please replace the -.. with the required I/O connection style (e.g. FN 2070-25-08, FN 2070B-10-06).

** Maximum leakage under usual AC operating conditions (acc. IEC60939-3). Note: if the neutral line is interrupted, worst case leakage could reach twice this level.

*** Tolerances apply: Inductance: -30/+50%, Capacitance: ±20%, Resistance: ±10%

Typical filter attenuation

Per CISPR 17; A=50 Ω/50 Ω sym; B=50 Ω/50 Ω asym; C=0.1 Ω/100 Ω sym; D=100 Ω/0.1 Ω sym

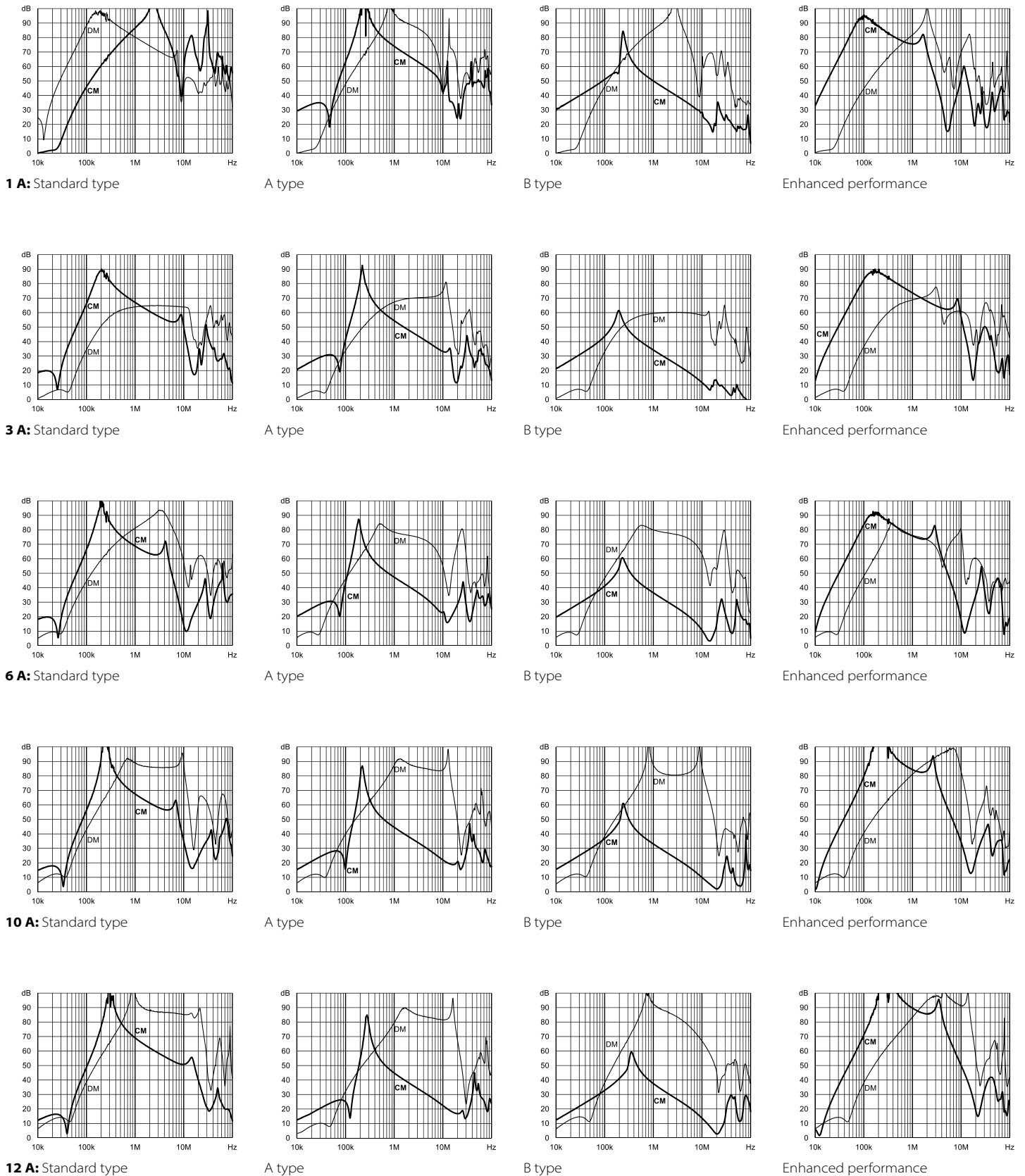

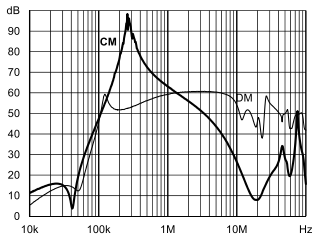

16 A: Standard type

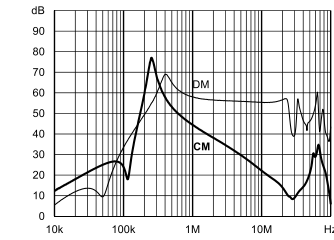

A type

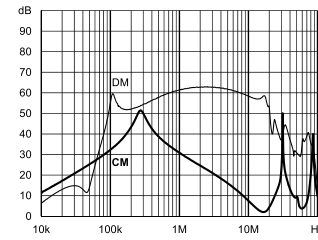

B type

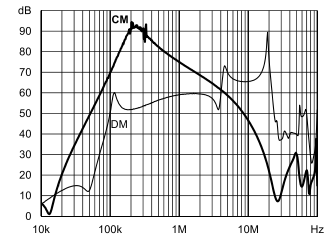

Enhanced performance

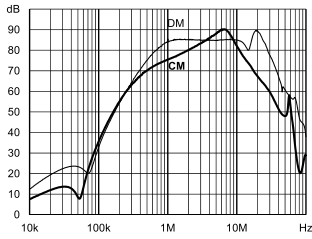

25 A: Standard type

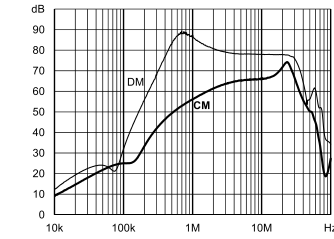

A type

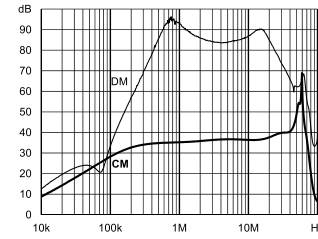

B type

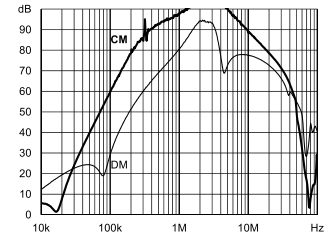

Enhanced performance

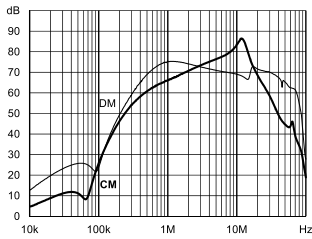

36 A: Standard type

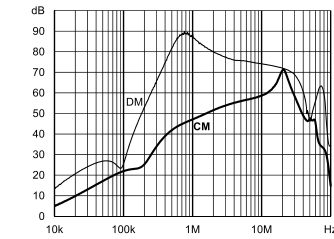

A type

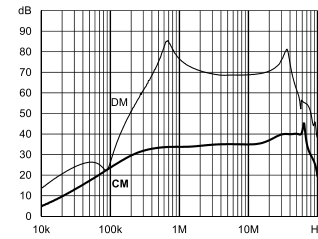

B type

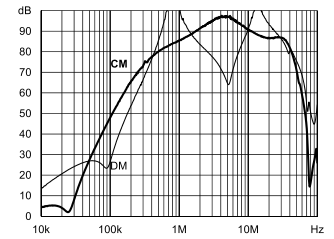

Enhanced performance

Product selector

FN 2070 x -xx-yy

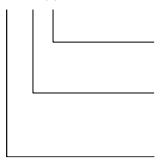

- 06 Faston 6.3 x 0.8 mm (spade/soldering)
- 07 Wire leads
- 08 Studs (M4 screws)
- 1 to 36 Rated current
- Blank Standard version
- A Safety version
- B Medical version
- L/M High performance version

Mechanical data

Connection style -06, 1 and 3 A types

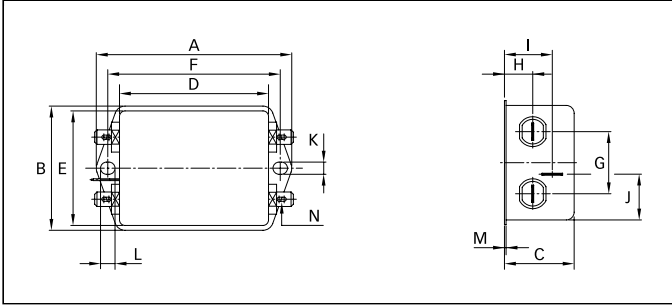

Connection style -06, 6 to 12 A types

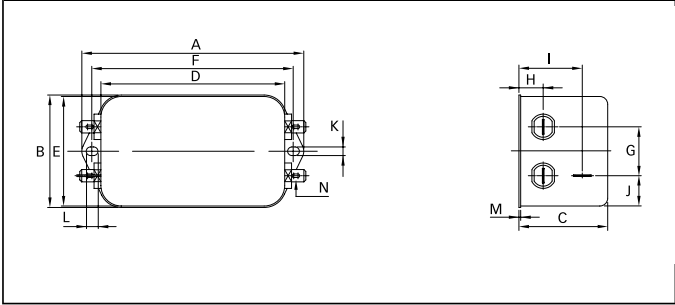

Connection style -06, 16 A types

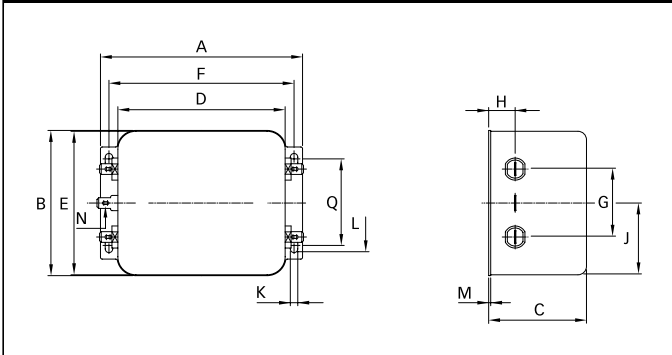

Connection style -07, 1 and 3 A types (same dimensions as style -06)

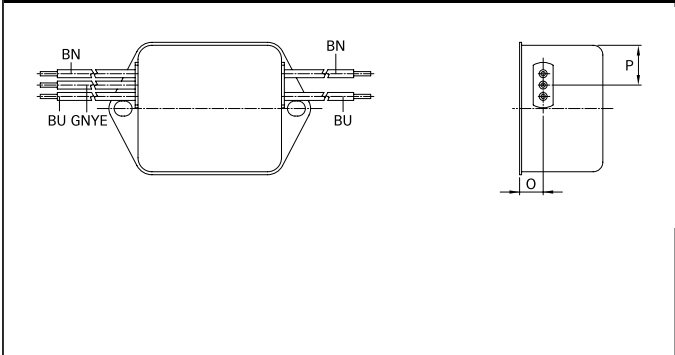

Connection style -07, 6 to 12 A types (same dimensions as style -06)

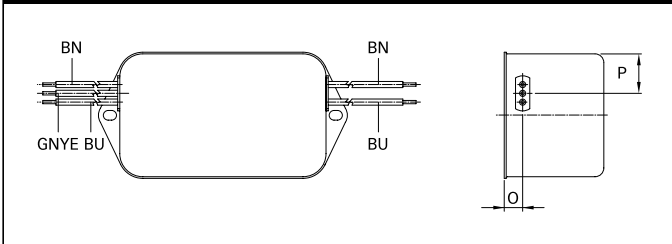

Connection style -07, 16 A types (same dimensions as style -06)

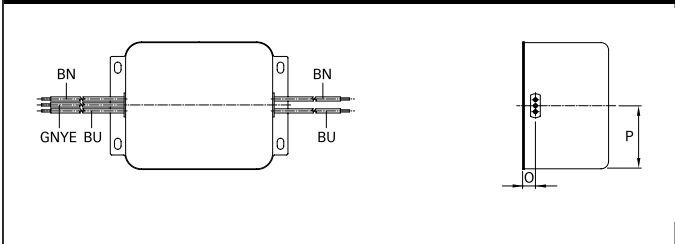

Connection style -08, 10 to 16 A types

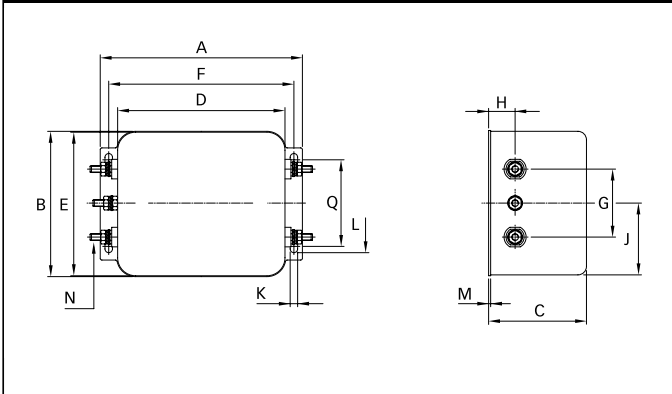

Connection style -08, 25 and 36 A types

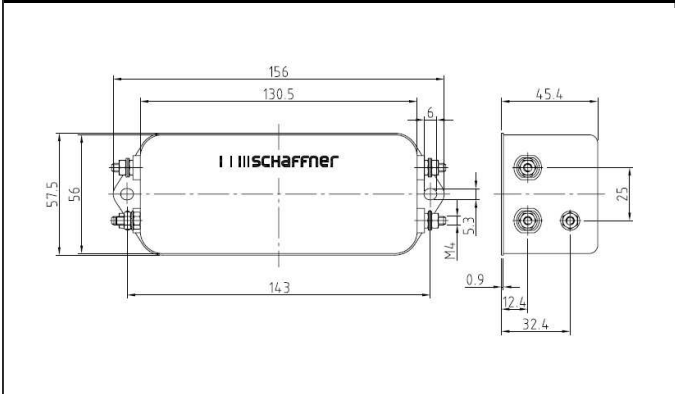

Dimensions

	1 A	3 A	6 A	10 A	12 A	16 A	25 A	36 A	Tolerances
A	85 ±0.5	85 ±0.5	113.5	156	156	119	156	156	±1
B	54 ±0.5	54 ±0.5	57.5	57.5	57.5	85.5	57.5	57.5	±1
C	30.3 ±0.5	40.3 ±0.5	45.4	45.4	45.4	57.6	45.4	45.4	±1
D	64.8 ±0.5	64.8 ±0.5	94	130.5	130.5	98.5	130.5	130.5	±1
E	49.8	49.8	56	56	56	84.5	56	56	±0.5
F	75	75	103	143	143	109	143	143	±0.3
G	27	27	25	25	25	40	25	25	±0.2
H	12.3	12.3	12.4	12.4	12.4	15.6	12.4	12.4	±0.5
I	20.8	29.8	32.4	32.5	32.5		32.5	32.5	±0.5
J	19.9	11.4	15.5	15.5	15.5	42.25	15.5	15.5	±0.5
K	5.3	5.3	4.4	5.3	5.3	4.4	5.3	5.3	
L	6.3	6.3	6	6	6	7.4	6	6	
M	0.7	0.7	1	1	1	1.2	1	1	±0.3
Connection style -06									
N	6.3 x 0.8	6.3 x 0.8	6.3 x 0.8	6.3 x 0.8	6.3 x 0.8	6.3 x 0.8			
Connection style -07									
O	8.3	8.3	8.4	8.4	8.4	8.6			±0.5
P	14.9	14.9	18	18	18	42.25			±0.5
AWG type wire	AWG 20	AWG 20	AWG 18	AWG 18	AWG 16	AWG 16			
Wire length	140	140	140	140	140	140			+5
Connection style -08									
N				M4	M4	M4	M4	M4	
Q						51			±0.2
Recommended torque (Nm)				1.2 - 1.3	1.2 - 1.3	1.2 - 1.3	1.2 - 1.3	1.2 - 1.3	
Earth terminal				1.5 - 1.7	1.5 - 1.7	1.5 - 1.7	1.5 - 1.7	1.5 - 1.7	

All dimensions in mm; 1 inch = 25.4 mm

Please visit www.schaffner.com to find more details on filter connectors.



Headquarters, global innovation and development

Switzerland

Schaffner Group

Industrie Nord
Nordstrasse 11e
4542 Luterbach
T +41 32 681 66 26
info@schaffner.com



Sales and application centers

China

Schaffner EMC Ltd. Shanghai

T20-3 C, No 565 Chuangye Road,
Pudong district
201201 Shanghai
T +86 21 3813 9500
cschina@schaffner.com
www.schaffner.com.cn

Finland

Schaffner Oy

Sauvonrinne 19 H
08500 Lohja
T +358 10 567 2855
finlandsales@schaffner.com

France

Schaffner EMC S.A.S.

16-20 Rue Louis Rameau
95875 Bezons
T +33 1 34 34 30 60
F +33 1 39 47 02 28
francesales@schaffner.com

Germany

Schaffner Deutschland GmbH

Schoemperlenstrasse 12B
76185 Karlsruhe
T +49 721 56910
F +49 721 569110
germanysales@schaffner.com

India

Schaffner India Pvt. Ltd

REGUS WORLD TRADE CENTRE
WTC, 22nd Floor Unit No 2238, Brigade
Gateway Campus, 26/1, Dr. Rajkumar Road
Malleshwaram (W)
560055 Bangalore
T +91 80 67935355
indiasales@schaffner.com

Italy

Schaffner EMC S.r.l.

Via Ticino, 30
20900 Monza (MB)
T +39 039 21 41 070
italysales@schaffner.com

Japan

Schaffner EMC K.K.

Taiju-Seimei Sangenjaya Bldg.
1-32-12, Kamiuma, Setagaya-ku
154-0011 Tokyo
T +81 3 5712 3650
F +81 3 5712 3651
japansales@schaffner.com
www.schaffner.jp

Singapore

Schaffner EMC Pte Ltd.

#05-09, Kg Ubi Ind. Estate
408705 Singapore
T +65 6377 3283
F +65 6377 3281
singaporesales@schaffner.com

Spain

Schaffner EMC España

Calle Caléndula 93, Miniparc III, Edificio E
El Soto de Moraleja, Alcobendas
28109 Madrid
T +34 917 912 900
F +34 917 912 901
spainsales@schaffner.com

Sweden

Schaffner EMC AB

Östermalmstorg 1
114 42 Stockholm
T +46 8 5050 2425
swedensales@schaffner.com
www.schaffner.com

Switzerland

Schaffner EMV AG

Industrie Nord
Nordstrasse 11e
4542 Luterbach
T +41 32 681 66 26
switzerlandsales@schaffner.com

Taiwan R.O.C.

Schaffner EMV Ltd.

20 Floor-2, No 97, Section 1, XinTai 5th Road
22175 XiZhi District New Taipei City 22175
T +886 2 2697 5500
F +886 2 2697 5533
taiwansales@schaffner.com
www.schaffner.com.tw

Thailand

Schaffner EMC Co. Ltd.

Northern Region Industrial Estate
67 Moo 4 Tambon Ban Klang
Amphur Muangng P.O. Box 14
51000 Lamphun
T +66 53 58 11 04
F +66 53 58 10 19
thailandsales@schaffner.com

United Kingdom

Schaffner Ltd.

1, Oakmede Place
Binfield
RG42 4JF Berkshire
T +44 118 9770070
F +44 118 9792969
uksales@schaffner.com

USA

Schaffner EMC Inc.

52 Mayfield Avenue
Edison, New Jersey
T +1 732 225 9533
F +1 732 225 4789
usasales@schaffner.com
www.schaffnerusa.com

Schaffner North America

6722 Thirlane Road
24019 Roanoke, Virginia
T +1 276 228 7943
F +1 276 228 7953

Schaffner North America

823 Fairview Road
24382 Wytheville, Virginia
T +1 276 228 7943
F +1 276 228 7258

To find your local partner within Schaffner's global network: www.schaffner.com

© 2018 Schaffner Group

The content of this document has been carefully checked and understood. However, neither Schaffner nor its subsidiaries assume any liability whatsoever for any errors or inaccuracies of this document and the consequences thereof. Published specifications are subject to change without notice. Product suitability for any area of application must ultimately be determined by the customer. In all cases, products must never be operated outside their published specifications. Schaffner does not guarantee the availability of all published products. This disclaimer shall be governed by substantive Swiss law and resulting disputes shall be settled by the courts at the place of business of Schaffner Holding AG. Latest publications and a complete disclaimer can be downloaded from the Schaffner website. All trademarks recognized.