

## AC Line Rated Ceramic Disc Capacitors Class X1, 760 V<sub>AC</sub> / Class Y1, 500 V<sub>AC</sub>



### LINKS TO ADDITIONAL RESOURCES



QUICK REFERENCE DATA				
DESCRIPTION	VALUE			
Ceramic class	1		2	
Ceramic dielectric	C0G, U2J, P3K, R3L	C0G, U2J, P3K, R3L	X7R, Y5U	X7R, Y5U
Voltage (V <sub>AC</sub> )	500	760	500	760
Min. capacitance (pF)	10		68	
Max. capacitance (pF)	47		20 000	
Mounting	Radial			

### INSULATION RESISTANCE

Min. 1000 ΩF

### TOLERANCE ON CAPACITANCE

± 10 %; ± 20 %

### DISSIPATION FACTOR

2.0 % max. at 1 kHz; 1 V

### CERAMIC DIELECTRIC

C0G, U2J, P3K, R3L (class 1)  
X7R, Y5U (class 2)

### OPERATING TEMPERATURE RANGE

-30 °C to +125 °C <sup>(1)</sup>

### CLIMATIC CATEGORY ACC. TO EN 60068-1

25/125/21

### Note

<sup>(1)</sup> For explanation about the difference of operating temperature range and temperature characteristic of capacitance please see [www.vishay.com/doc?48299](http://www.vishay.com/doc?48299)

### FEATURES

- Complies with IEC 60384-14
- Complies with IEC 60384-14 annex H humidity robustness grade III B (highest)
- High reliability
- Radial leads
- High capacitance up to 20 nF
- Singlelayer AC disc safety capacitors
- Material categorization: for definitions of compliance please see [www.vishay.com/doc?99912](http://www.vishay.com/doc?99912)



**RoHS**  
COMPLIANT

### APPLICATIONS

- X1, Y1 according to IEC 60384-14
- Across-the-line
- Line by-pass
- Antenna coupling
- Applications at large temperature and / or high humidity

### DESIGN

The capacitors consist of a ceramic disc of which both sides are silver-plated. Connection leads are made of tinned copper having a diameter of 0.032" (0.81 mm). The capacitors may be supplied with radial kinked or straight leads having a lead spacing of 0.375" (9.5 mm). The standard tolerances are ± 10 % or ± 20 %. Coating is made of flame-retardant epoxy resin in accordance with "UL 94 V-0."

### CAPACITANCE RANGE

10 pF to 20 nF

### RATED VOLTAGE

IEC 60384-14:

- X1: 760 V<sub>AC</sub>, 50 Hz
- Y1: 500 V<sub>AC</sub>, 50 Hz

### DIELECTRIC STRENGTH BETWEEN LEADS

Component test, 100 % test at production line:  
4000 V<sub>AC</sub>, 50 Hz, 2 s

As repeated test at customer side admissible only once with:  
3600 V<sub>AC</sub>, 50 Hz, 2 s

Random sampling test (destructive test):  
4000 V<sub>AC</sub>, 50 Hz, 60 s

### DIELECTRIC STRENGTH OF BODY INSULATION

4000 V<sub>AC</sub>, 50 Hz, 60 s (destructive test)

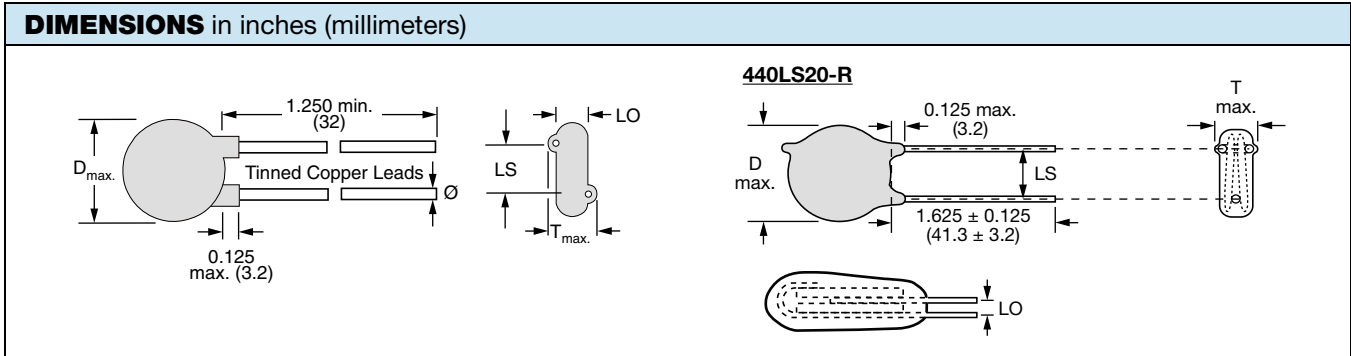

ORDERING INFORMATION, CERAMIC X1 / Y1 CAPACITORS 440L								
C (pF)	TOL. (%)	D <sub>max.</sub> DIAMETER INCH (mm)	T <sub>max.</sub> THICKNESS INCH (mm)	WIRE SIZE		LS LEAD SPACE INCH (mm) ± 1 mm	LO LEAD OFFSET INCH (mm) ± 0.5 mm	ORDERING CODE
				AWG	INCH (mm)			
<b>C0G</b>								
10	± 10	0.330 (8.4)	0.195 (5.0)	20	0.032 (0.81)	0.375 (9.5)	0.098 (2.5)	440LQ10-R
<b>U2J</b>								
15	± 10	0.330 (8.4)	0.210 (5.3)	20	0.032 (0.81)	0.375 (9.5)	0.110 (2.8)	440LQ15-R
<b>P3K</b>								
22	± 10	0.330 (8.4)	0.190 (4.8)	20	0.032 (0.81)	0.375 (9.5)	0.094 (2.4)	440LQ22-R
<b>R3L</b>								
33	± 10	0.330 (8.4)	0.200 (5.1)	20	0.032 (0.81)	0.375 (9.5)	0.102 (2.6)	440LQ33-R
47	± 10	0.330 (8.4)	0.180 (4.6)	20	0.032 (0.81)	0.375 (9.5)	0.083 (2.1)	440LQ47-R
<b>X7R</b>								
68	± 10	0.330 (8.4)	0.220 (5.6)	20	0.032 (0.81)	0.375 (9.5)	0.122 (3.1)	440LQ68-R
100			0.220 (5.6)				0.122 (3.1)	440LT10-R
150			0.235 (6.0)				0.138 (3.5)	440LT15-R
220			0.235 (6.0)				0.138 (3.5)	440LT22-R
330			0.225 (5.7)				0.126 (3.2)	440LT33-R
<b>Y5U</b>								
470	± 20	0.330 (8.4)	0.230 (5.8)	20	0.032 (0.81)	0.375 (9.5)	0.130 (3.3)	440LT47-R
560		0.330 (8.4)	0.230 (5.8)				0.130 (3.3)	440LT56-R
680		0.330 (8.4)	0.235 (6.0)				0.138 (3.5)	440LT68-R
1000		0.365 (9.3)	0.225 (5.7)				0.126 (3.2)	440LD10-R
1500		0.365 (9.3)	0.220 (5.6)				0.118 (3.0)	440LD15-R
2000		0.400 (10.2)	0.220 (5.6)				0.118 (3.0)	440LD20-R
2200		0.430 (10.9)	0.225 (5.7)				0.126 (3.2)	440LD22-R
2700		0.460 (11.7)	0.225 (5.7)				0.126 (3.2)	440LD27-R
2800		0.460 (11.7)	0.220 (5.6)				0.122 (3.1)	440LD28-R
3000		0.490 (12.4)	0.225 (5.7)				0.126 (3.2)	440LD30-R
3200		0.490 (12.4)	0.220 (5.6)				0.122 (3.1)	440LD32-R
3300		0.490 (12.4)	0.220 (5.6)				0.122 (3.1)	440LD33-R
3900		0.530 (13.5)	0.220 (5.6)				0.118 (3.0)	440LD39-R
4000		0.530 (13.5)	0.220 (5.6)				0.122 (3.1)	440LD40-R
4700		0.620 (15.7)	0.230 (5.8)				0.130 (3.3)	440LD47-R
5000		0.620 (15.7)	0.225 (5.7)				0.126 (3.2)	440LD50-R
5500		0.680 (17.3)	0.230 (5.8)				0.134 (3.4)	440LD55-R
5600		0.680 (17.3)	0.230 (5.8)				0.134 (3.4)	440LD56-R
6800		0.720 (18.3)	0.235 (6.0)				0.138 (3.5)	440LD68-R
8000		0.720 (18.3)	0.220 (5.6)				0.122 (3.1)	440LD80-R
9000		0.790 (20.1)	0.225 (5.7)				0.126 (3.2)	440LD90-R
10 000	0.850 (21.6)	0.230 (5.8)	0.134 (3.4)	440LS10-R				
20 000	0.850 (21.6)	0.355 (9.0)	0.134 (3.4)	440LS20-R				

**Notes**

- Alternate lead spacings are available bulk or tape and reel on request
- Minimum lead clearance according to IEC 60384-14: 0.315" (8 mm)

**WIRE LEAD OPTIONS - BULK PACKAGED**

Radial leaded capacitors may be ordered with various wire lead options by adding appropriate suffix code to the catalog part number.

Example: 440LD22UG-R (suffix code) specifies:

#20 AWG wire; LS = 0.375"; inline wire; long lead length, bulk packed

WIRE FORM DESCRIPTION	FIG.	LEAD LENGTH	LEAD SPACING					
			0.375" (9.5 mm)		0.400" (10.0 mm)		0.500" (12.7 mm)	
			#20 AWG	#22 AWG	#20 AWG	#22 AWG	#20 AWG	#22 AWG
Straight wire	1	Long "LL"	AJ	BJ	AD	BL	AM	BM
Inline wire	2	Long "LL" Cut "CL"	UG	UJ	UL	UM	UQ	US
			UH	UK	UN	UP	UR	UT

**Notes**

- Popular wire lead form options are described above; consult factory for other available forms [www.vishay.com/doc?23140](http://www.vishay.com/doc?23140)
- Practical consideration may limit wire options depending on capacitor size - verify special requirements with factory
- For detailed information and figures see general information: [www.vishay.com/doc?23140](http://www.vishay.com/doc?23140)



Fig. 1 - Straight wire

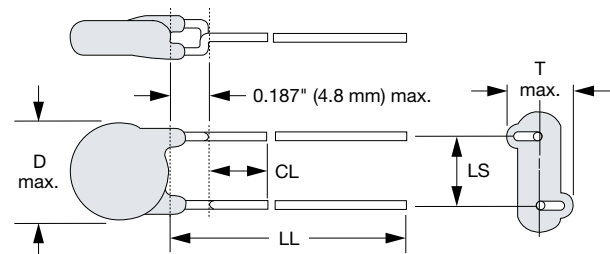

Minimum CL = 0.120" (3 mm) inline wire, LO = 0

Fig. 2 - Inline wire

WIRE INFORMATION	
#20 AWG	0.032" (0.81) tinned copper wire
#22 AWG	0.025" (0.64) tinned copper wire

LEAD LENGTH INFORMATION
• Standard long lead "LL" length = 1.250" (32 mm) minimum
• Cut lead "CL" length may be user specified; if unspecified, Vishay Cera-Mite supplies 0.187" (4.8 mm) EIA standard
• Cut lead lengths are measured from bottom of wire seating plane (wire support point on circuit board)
• Cut lead length tolerance: + 0.031" / - 0.015" (+ 0.8 mm / - 0.4 mm)

**TAPE AND REEL OPTIONS**

Radial leaded parts may be ordered with tape and reel packaging by adding appropriate suffix code to part number, like for wire lead options.

TAPE AND REEL PACKAGING PART NUMBER SUFFIX				TAPE AND REEL SUFFIX CODES FOR VARIOUS WIRE FORMS AND SIZES				
TAPE AND REEL FIG.	LS (mm)	MAX. DISC DIAMETER		TAPE AND REEL STANDARD	STRAIGHT WIRE FIG. 1		INLINE WIRE FIG. 2	
		(in)	(mm)		#20 AWG	#22 AWG	#20 AWG	#22 AWG
C <sup>(1)</sup>	10	0.708	18.0	EIA	AP	QX	XK	XT

**Note**

<sup>(1)</sup> Figure can be found in general information [www.vishay.com/doc?23140](http://www.vishay.com/doc?23140), section Tape and Reel Options

**REELING STANDARD EIA-468B**

EIA lead spacings for tape and reel are based on multiples of 0.100" (2.5 mm) to coordinate with automatic insertion machinery and boards using 0.100" grid convention.

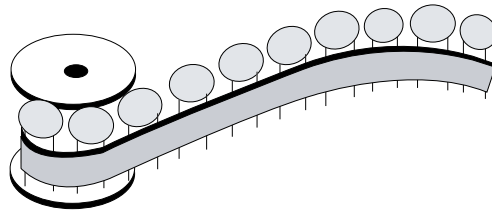
**Notes**

- Popular tape and reel options are described above; consult factory for other available options [www.vishay.com/doc?23140](http://www.vishay.com/doc?23140)
- Practical consideration may limit tape and reel options on capacitor size - verify special requirements with factory
- For detailed information and figures see general information: [www.vishay.com/doc?23140](http://www.vishay.com/doc?23140)

**APPROVALS**

IEC 60384-14 - Safety tests  
This approval together with CB test certificate substitutes all national approvals.

**CB Certificate** ([www.vishay.com/doc?22237](http://www.vishay.com/doc?22237))

Y1-capacitor: CB test certificate:	DE1-63481	10 pF to 20 nF	500 V <sub>AC</sub>	
X1-capacitor: CB test certificate:	DE1-63481	10 pF to 20 nF	760 V <sub>AC</sub>	

**VDE** ([www.vishay.com/doc?22238](http://www.vishay.com/doc?22238))

Y1-capacitor: VDE marks approval:	40003985	10 pF to 20 nF	500 V <sub>AC</sub>	
X1-capacitor: VDE marks approval:	40003985	10 pF to 20 nF	400 V <sub>AC</sub>	

DIN EN 60384-14 VDE 0565-1-1 - Safety tests, annex H (humidity robustness grade IIIB)

**Underwriters Laboratories Inc.** ([www.vishay.com/doc?22239](http://www.vishay.com/doc?22239))

Y1-capacitor: UL test certificate:	E99264	10 pF to 20 nF	500 V <sub>AC</sub>	
X1-capacitor: UL test certificate:	E99264	10 pF to 20 nF	760 V <sub>AC</sub>	

UL 60384-14, CSA E60384-1, CSA E60384-14

Fixed capacitors for electromagnetic interference suppression and connection to the supply mains.

**MARKING**

Sample

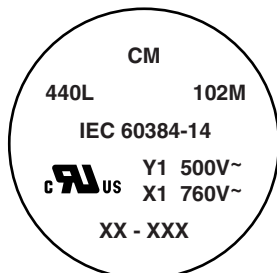

PN:440LD68-R	LOT1:34815452	DC1:1949
Cap.:9800PF ± 20%	LOT2:	DC2:
Ur.:Y1(500~),X1(760~)	BATCH NO.:201949CZ	
Qty.:100	R.C.:7032	S.L.:0010
IEC 60384-14:2013:		
	SN:292133DDC018	
PO:0034815452/0001		

**Notes**

- Marking IEC 60384-14 not shown on  $\varnothing \leq 9$  mm
- "XX - XXX" is placeholder for date code and lot number:  
"XX -" is the year and month according to IEC 60062, "- XXX" is last 3 digits of the lot number



CAPACITANCE CHANGE VS. TEMPERATURE (TYPICAL)

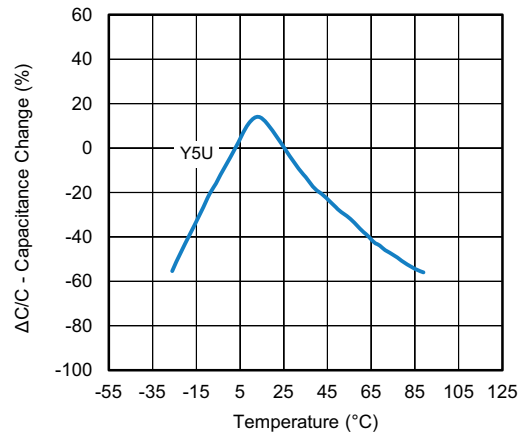
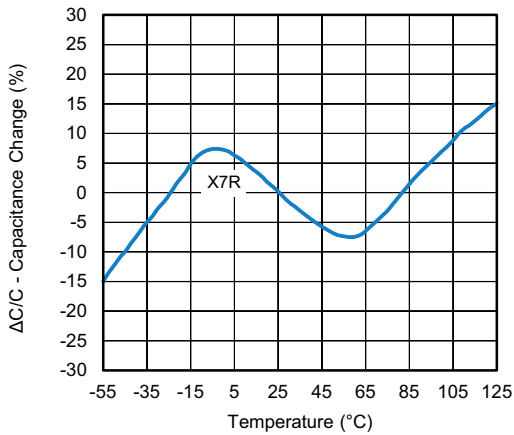
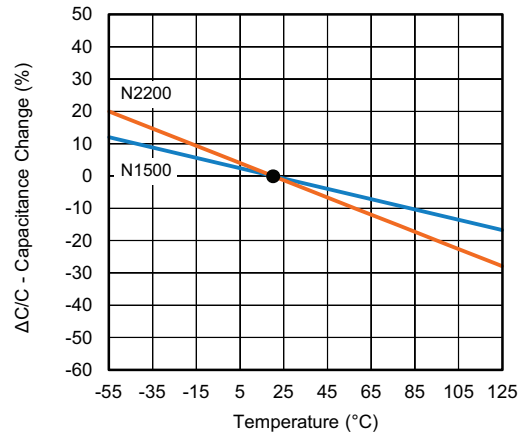
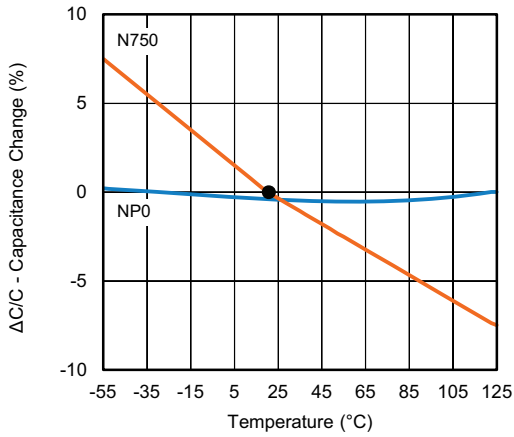

AC CURRENT VS. VOLTAGE

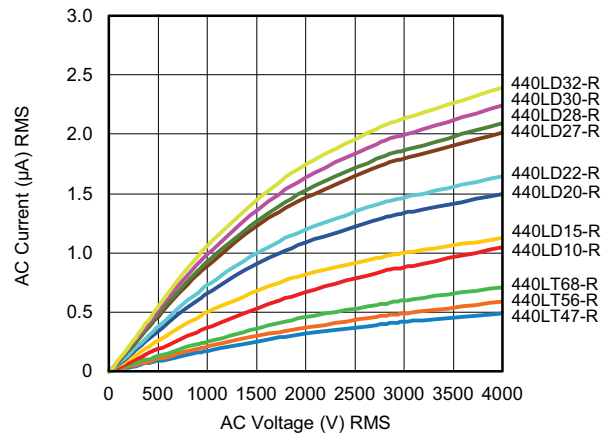
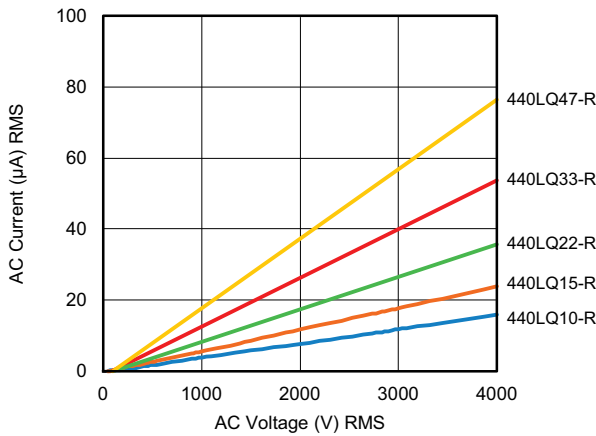

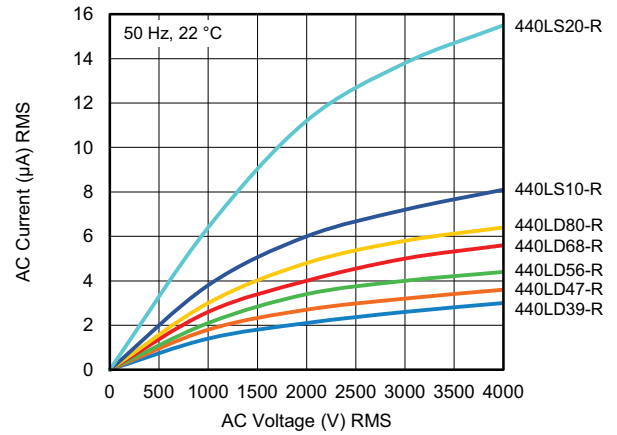
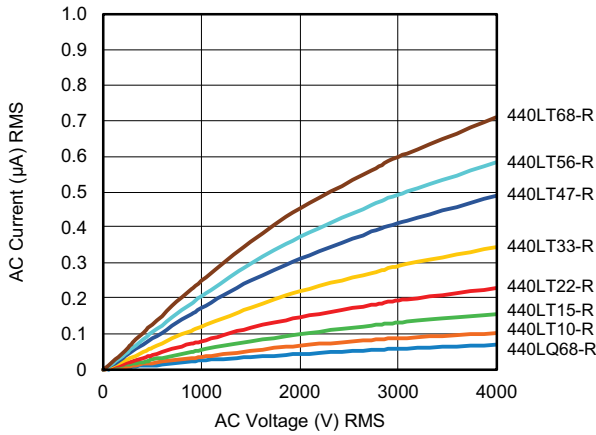

### IMPEDANCE VS. FREQUENCY (Wire Length 10 mm)

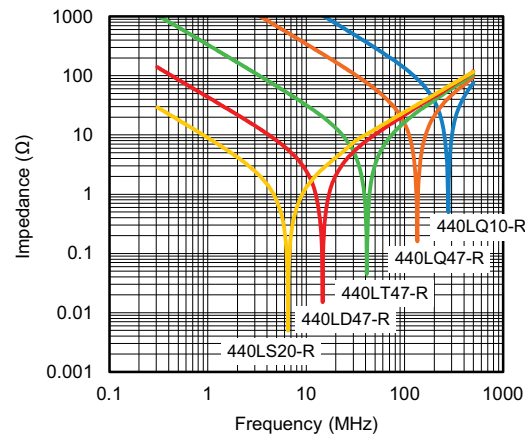



**STORAGE**

The capacitors must not be stored in a corrosive atmosphere, where sulphide or chloride gas, acid, alkali or salt are present. Exposure of the components to moisture, should be avoided. The solderability of the leads is not affected by storage of up to 24 months (temperature +10 °C to +40 °C, relative humidity up to 60 % RH). Class 2 ceramic dielectric capacitors are also subject to aging see general information ([www.vishay.com/doc?23140](http://www.vishay.com/doc?23140)).

**SOLDERING**

<b>SOLDERING SPECIFICATIONS</b>		
Soldering test for capacitors with wire leads: (according to IEC 60068-2-20, solder bath method)		
	<b>SOLDERABILITY</b>	<b>RESISTANCE TO SOLDERING HEAT</b>
Soldering temperature	(235 ± 5) °C	(260 ± 5) °C
Soldering duration	(2 ± 0.5) s	(10 ± 1) s
Distance from component body	≥ 2 mm	≥ 5 mm

**SOLDERING RECOMMENDATIONS**

Ceramic capacitors are very sensitive to rapid changes in temperature (thermal shock) therefore the solder heat resistance specification (see table above) should not be exceeded. Exposing the capacitor to excessive heating may result in thermal shocks that can crack the ceramic body. Similarly, excessive heating can cause the internal solder junction to melt.

When soldering radial leaded ceramic capacitors with a soldering iron, it should be performed under the following conditions and should not exceed:

- Maximum temperature of iron-tip: 400 °C
- Maximum soldering iron wattage: 50 W
- Maximum soldering time: 3.5 s

Failure to follow the above cautions may result, in worst case, in short circuit or cause fuming or thermo-mechanical damage when the product is used.

Leaded ceramic capacitors are not designed for reflow process or dipping the body into a solder melt.

**CLEANING**

The components should be cleaned immediately following the soldering operation with vapor degreasers.

**CLEANING (ULTRASONIC CLEANING)**

To perform ultrasonic cleaning, observe the following conditions:

- Maximum rinse bath capacity output: 20 W/liter
- Maximum rinsing time: 300 s
- Do not vibrate the PCB/PWB directly
- Excessive ultrasonic cleaning may lead to mechanical damage

**SOLVENT RESISTANCE**

The coating and marking of the capacitors are resistant to the following test method:

IEC 60068-2-45 (method XA)

**MOUNTING**

We do not recommend modifying the lead terminals, e.g. bending or cropping. This action could break the coating or crack the ceramic insert. In order to avoid such failures we are offering different lead wire designs (e.g. straight, inline, inside crimp, outside crimp etc.) If however, the lead must be modified in any way, we recommend support of the lead with a clamping fixture next to the coating. If a defined product stop is required for mounting on a PCB, a mechanically formed product stop or a mounting tool should be used.



**OPERATING VOLTAGE**

In case the voltage is applied to the circuit, starting as well as stopping, may generate irregular voltage for a transit period because of resonance or switching. Be sure to use a capacitor with a rated voltage range that includes these irregular voltages.

**OPERATING TEMPERATURE AND SELF-GENERATED HEAT**

Keep the surface temperature of a capacitor below the upper limit of its rated operating temperature range. Be sure to take into account the heat generated by the capacitor itself. When the capacitor is used in a high frequency, pulse, or similar application, it may have self-generated heat due to dielectric dissipation.

Temperature increase due to self-generated heating should not exceed 20 °C while operating at an atmosphere temperature of 25 °C.

When measuring, the surface temperature, make sure that the capacitor is not affected by radiant, conductive and convective heat by its surroundings. Excessive heat may lead to thermo-mechanical deterioration of the capacitor's characteristics and reliability.

<b>RELATED DOCUMENTS</b>	
General Information	<a href="http://www.vishay.com/doc?23140">www.vishay.com/doc?23140</a>
CB Test Certificate	<a href="http://www.vishay.com/doc?22237">www.vishay.com/doc?22237</a>
VDE Marks Approval	<a href="http://www.vishay.com/doc?22238">www.vishay.com/doc?22238</a>
UL Test Certificate	<a href="http://www.vishay.com/doc?22239">www.vishay.com/doc?22239</a>





## **Disclaimer**

ALL PRODUCT, PRODUCT SPECIFICATIONS AND DATA ARE SUBJECT TO CHANGE WITHOUT NOTICE TO IMPROVE RELIABILITY, FUNCTION OR DESIGN OR OTHERWISE.

Vishay Intertechnology, Inc., its affiliates, agents, and employees, and all persons acting on its or their behalf (collectively, "Vishay"), disclaim any and all liability for any errors, inaccuracies or incompleteness contained in any datasheet or in any other disclosure relating to any product.

Vishay makes no warranty, representation or guarantee regarding the suitability of the products for any particular purpose or the continuing production of any product. To the maximum extent permitted by applicable law, Vishay disclaims (i) any and all liability arising out of the application or use of any product, (ii) any and all liability, including without limitation special, consequential or incidental damages, and (iii) any and all implied warranties, including warranties of fitness for particular purpose, non-infringement and merchantability.

Statements regarding the suitability of products for certain types of applications are based on Vishay's knowledge of typical requirements that are often placed on Vishay products in generic applications. Such statements are not binding statements about the suitability of products for a particular application. It is the customer's responsibility to validate that a particular product with the properties described in the product specification is suitable for use in a particular application. Parameters provided in datasheets and / or specifications may vary in different applications and performance may vary over time. All operating parameters, including typical parameters, must be validated for each customer application by the customer's technical experts. Product specifications do not expand or otherwise modify Vishay's terms and conditions of purchase, including but not limited to the warranty expressed therein.

Except as expressly indicated in writing, Vishay products are not designed for use in medical, life-saving, or life-sustaining applications or for any other application in which the failure of the Vishay product could result in personal injury or death. Customers using or selling Vishay products not expressly indicated for use in such applications do so at their own risk. Please contact authorized Vishay personnel to obtain written terms and conditions regarding products designed for such applications.

No license, express or implied, by estoppel or otherwise, to any intellectual property rights is granted by this document or by any conduct of Vishay. Product names and markings noted herein may be trademarks of their respective owners.