

# Solid-state Timer

## H3CR

Please read and understand this catalog before purchasing the products. Please consult your OMRON representative if you have any questions or comments. Refer to Warranty and Application Considerations (page 52), and Safety Precautions (page 22, 44, 51).

### DIN 48 × 48-mm Multifunctional Timer Series

- Conforms to EN61812-1 and IEC60664-1 4 kV/2 for Low Voltage, and EMC Directives.
- Approved by UL and CSA.
- Lloyds/NK approvals.
- Six-language instruction manual provided.

### ■ Broad Line-up of H3CR Series

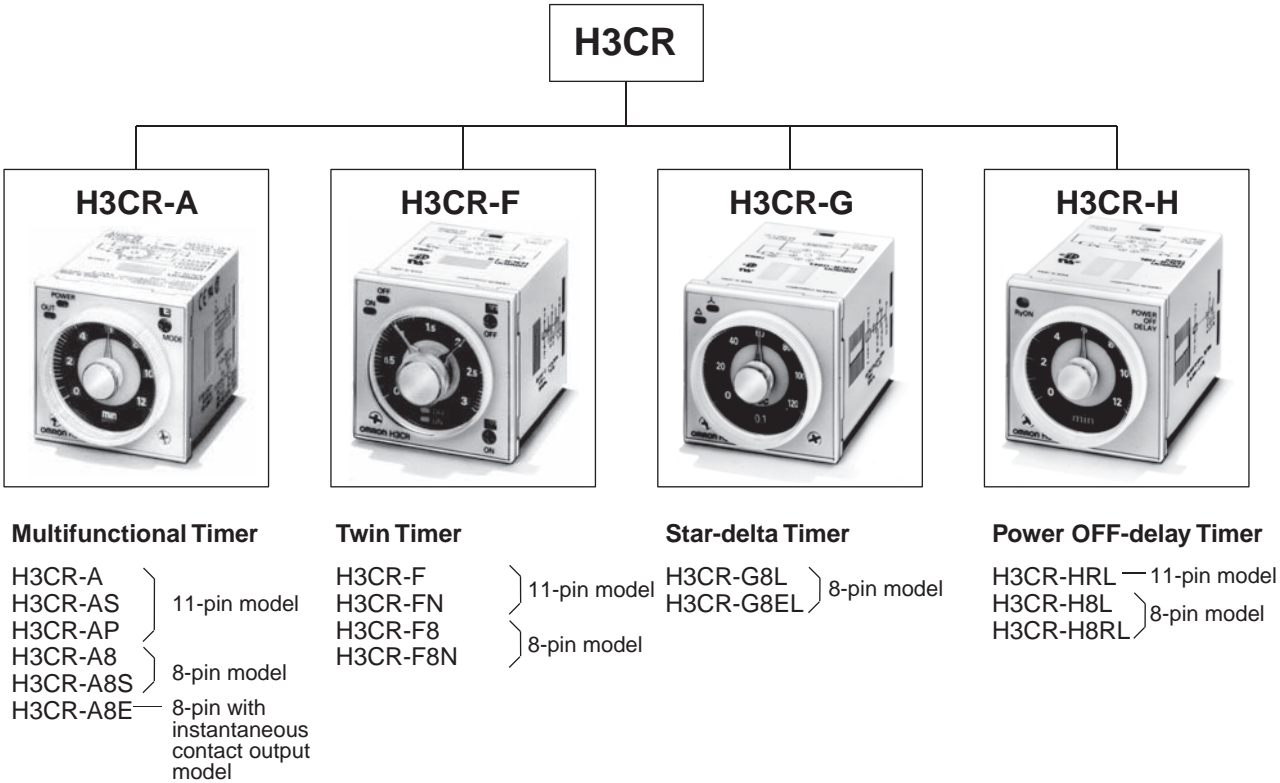

**Note:** H3CR-AS, H3CR-A8S: Transistor output models

## Contents

<b>Solid-state Timer</b>	
H3CR-A .....	2
H3CR-F .....	26
H3CR-G .....	34
H3CR-H .....	42
<b>Common to ALL Timers</b>	
Operation .....	52
Accessories .....	54
Safety Precautions .....	58

## Multiple Operating Modes and Multiple Time Ranges. DIN 48 x 48-mm Multifunctional Timer.

- A wide AC/DC power supply range greatly reduces the number of timer models kept in stock.
- A wide range of applications with multiple operating modes, eight modes for 11-pin models and five modes for 8-pin models.
- Ecological design with reduced current consumption.
- Easy sequence checking with instantaneous outputs for a zero set value.
- Length of 75 mm or less when panel-mounted with a P3G-08 Socket (H3CR-A8E, 100 to 240 VAC, 100 to 125 VDC)
- PNP input models available.
- Standards: UL, CSA, NK, LR, CCC, EN 61812-1, and CE Marking.



For the most recent information on models that have been certified for safety standards, refer to your OMRON website.

## Model Number Structure

### ■ Model Number Legend

**Note:** This model number legend includes combinations that are not available. Before ordering, please check the *List of Models* on page 3 for availability.

H3CR-A    -    
1 2 3 4 5

#### 1. Number of Pins

- None: 11-pin models
- 8: 8-pin models

#### 2. Input Type for 11-pin Models

- None: No-voltage input (NPN type)
- P: Voltage input (PNP type)

#### 3. Output

- None: Relay output (DPDT)
- S: Transistor output (NPN/PNP universal use)
- E: Relay output (SPDT) with instantaneous relay output (SPDT)

#### 4. Suffix

- 301: Double time scale (range) models (0.1 s to 600 h)

#### 5. Supply Voltage

- 100-240AC/100-125DC: 100 to 240 VAC/100 to 125 VDC
- 24-48AC/12-48DC: 24 to 48 VAC/12 to 48 VDC
- 24-48AC/DC: 24 to 48 VAC/VDC (Only for H3CR-A8E)

# Ordering Information

## List of Models

**Note:** 1. Specify both the model number and supply voltage when ordering.

Example: H3CR-A 100-240AC/100-125DC

Supply voltage

2. The operating modes are as follows

A: ON-delay  
 B: Flicker OFF start  
 B2: Flicker ON start  
 C: Signal ON/OFF-delay  
 D: Signal OFF-delay  
 E: Interval  
 G: Signal ON/OFF-delay  
 J: One-shot

## 11-pin Models

Output	Supply voltage	Input type	Time range	Operating mode (See note 2)	Model (See note 1.)				
Contact	100 to 240 VAC (50/60 Hz)/ 100 to 125 VDC	No-voltage input	0.05 s to 300 h	Eight multi-modes: A, B, B2, C, D, E, G, J	H3CR-A				
	24 to 48 VAC (50/60 Hz)/ 12 to 48 VDC								
	100 to 240 VAC (50/60 Hz)/ 100 to 125 VDC	Voltage input			0.1 s to 600 h	Eight multi-modes: A, B, B2, C, D, E, G, J	H3CR-AP		
	24 to 48 VAC (50/60 Hz)/ 12 to 48 VDC								
	100 to 240 VAC (50/60 Hz)/ 100 to 125 VDC	No-voltage input					0.05 s to 300 h		H3CR-A-301
	24 to 48 VAC (50/60 Hz)/ 12 to 48 VDC								
Transistor (Photocoupler)	24 to 48 VAC (50/60 Hz)/ 12 to 48 VDC								H3CR-AS

## 8-pin Models

Output	Supply voltage	Input type	Time range	Operating mode (See note 2)	Model (See note 1.)
Contact	100 to 240 VAC (50/60 Hz)/ 100 to 125 VDC	No-input available	0.05 s to 300 h	Five multi-modes: A, B, B2, E, J (Power supply start)	H3CR-A8
	24 to 48 VAC (50/60 Hz)/ 12 to 48 VDC		0.1 s to 600 h		H3CR-A8-301
	100 to 240 VAC (50/60 Hz)/ 100 to 125 VDC				
	24 to 48 VAC (50/60 Hz)/ 12 to 48 VDC				
Transistor (Photocoupler)	24 to 48 VAC (50/60 Hz)/ 12 to 48 VDC		0.05 s to 300 h		H3CR-A8S
Time-limit contact and instantaneous contact	100 to 240 VAC (50/60 Hz)/ 100 to 125 VDC				H3CR-A8E
	24 to 48 VAC/VDC (50/60 Hz)				

## ■ Accessories (Order Separately)

### Adapter, Protective Cover, Hold down Clip, Setting Ring and Panel Cover

Name/specifications		Models
Flush Mounting Adapter		Y92F-30
		Y92F-73 *1
		Y92F-74 *1
Protective Cover		Y92A-48B *2
Hold-down Clip (Sold in sets of two)	For PF085A Socket	Y92H-8
	For PL08 or PL11 Sockets	Y92H-7
Setting Ring A		Y92S-27 *3
Setting Ring B and C		Y92S-28 *3
Panel Cover	Light gray (5Y7/1)	Y92P-48GL *4
	Black (N1.5)	Y92P-48GB *4

\*1 The Y92A-48B Protective Cover and the Y92P-48G□ Panel Cover can not be used at the same time with the Y92F-73/-74 Flush Mounting Adapter.

\*2 The Y92A-48B Protective Cover is made from hard plastic. Remove the Protective Cover to change to set value. The Y92F-73/-74 Flush Mounting Adapter and the Y92P-48G□ Panel Cover cannot be used at the same time with Y92A-48B Protective Cover.

\*3 The Y92S-27/-28 Setting Ring cannot be used alone. It must be used together with the Y92P-48G□ Panel Cover.

\*4 The Y92A-48B Protective Cover and the Y92F-73/-74 Flush Mounting Adapter cannot be used at the same time with the Y92P-48G□ Panel Cover.

## Sockets

Timer Pin	Round Sockets		
	Connection	Terminal	Models
11-pin	Front Connecting	DIN track mounting	P2CF-11
		DIN track mounting (Finger-safe type)	P2CF-11-E
	Back Connecting	Screw terminal	P3GA-11
		Solder terminal	PL11
		Wrapping terminal	PL11-Q
PCB terminal	PLE11-0		
8-pin	Front Connecting	DIN track mounting	P2CF-08
		DIN track mounting (Finger-safe type)	P2CF-08-E
		DIN track mounting	PF085A
	Back Connecting	Screw terminal	P3G-08
		Solder terminal	PL08
		Wrapping terminal	PL08-Q
		PCB terminal	PLE08-0

**Note: 1.** The P2CF-□□-E has a finger-protection structure. Round crimp terminals cannot be used. Use forked crimp terminals.

**2.** The P3GA-11 and P3G-08 Socket can be used together with the Y92A-48G Terminal Cover to implement finger protection.

**3.** For details, refer to your OMRON website.

## Terminal Cover

Application	Model	Remarks
For back connecting socket	Y92A-48G	For P3G-08 and P3GA-11

**Note:** For details, refer to your OMRON website.

# Specifications

## ■ General

Item	H3CR-A/-AS/-A-301	H3CR-AP	H3CR-A8/-A8S/-A8-301	H3CR-A8E
Operating mode	A: ON-delay B: Flicker OFF start B2: Flicker ON start C: Signal ON/OFF-delay D: Signal OFF-delay E: Interval G: Signal ON/OFF-delay J: One-shot		A: ON-delay (power supply start) B: Flicker OFF start (power supply start) B2: Flicker ON start (power supply start) E: Interval (power supply start) J: One-shot (power supply start)	
Pin type	11-pin		8-pin	
Input type	No-voltage input	Voltage input	---	
Time-limit output type	H3CR-A/-A8/-AP/-A-301/-A8-301: Relay output (DPDT) H3CR-AS/-A8S: Transistor output (NPN/PNP universal)*			Relay output (SPDT)
Instantaneous output type	---			Relay output (SPDT)
Mounting method	DIN track mounting, surface mounting, and flush mounting			
Approved standards	UL508, CSA C22.2 No.14, NK, Lloyds, CCC Conforms to EN61812-1 and IEC60664-1 (VDE0110) 4kV/2. Output category according to EN60947-5-1 for Timers with Contact Outputs. Output category according to EN60947-5-2 for Timers with Transistor Outputs.			

\* The internal circuits are optically isolated from the output. This enables universal application as NPN or PNP transistor.  
For details, refer to your OMRON website.

## ■ Time Ranges

**Note:** When the time setting knob is turned below "0" until the point where the time setting knob stops, the output will operate instantaneously at all time range settings.  
For details, refer to your OMRON website.

### Standard (0.05-s to 300-h) Models

Time unit	s (sec)	×10 s (10 sec)	min (min)	×10 min (10 min)	h (hrs)	×10 h (10 hrs)	
Full scale setting	1.2	0.05 to 1.2	1.2 to 12	0.12 to 1.2	1.2 to 12	0.12 to 1.2	1.2 to 12
	3	0.3 to 3	3 to 30	0.3 to 3	3 to 30	0.3 to 3	3 to 30
	12	1.2 to 12	12 to 120	1.2 to 12	12 to 120	1.2 to 12	12 to 120
	30	3 to 30	30 to 300	3 to 30	30 to 300	3 to 30	30 to 300

### Double (0.1-s to 600-h) Models

Time unit	s (sec)	×10 s (10 sec)	min (min)	×10 min (10 min)	h (hrs)	×10 h (10 hrs)	
Full scale setting	2.4	0.1 to 2.4	2.4 to 24	0.24 to 2.4	2.4 to 24	0.24 to 2.4	2.4 to 24
	6	0.6 to 6	6 to 60	0.6 to 6	6 to 60	0.6 to 6	6 to 60
	24	2.4 to 24	24 to 240	2.4 to 24	24 to 240	2.4 to 24	24 to 240
	60	6 to 60	60 to 600	6 to 60	60 to 600	6 to 60	60 to 600

## ■ Ratings

<b>Rated supply voltage (See notes 1, 2, and 5.)</b>	100 to 240 VAC (50/60 Hz)/100 to 125 VDC, 24 to 48 VAC (50/60 Hz)/12 to 48 VDC (24 to 48 VAC/VDC for H3CR-A8E) (See note 3.)
<b>Operating voltage range</b>	85% to 110% of rated supply voltage (90% to 110% at 12 VDC)
<b>Power reset</b>	Minimum power-opening time: 0.1 s
<b>Input (See note 6.)</b>	<p><u>No-voltage Input</u>  ON impedance: 1 k<math>\Omega</math> max.  ON residual voltage: 1 V max.  OFF impedance: 100 k<math>\Omega</math> min.</p> <p><u>Voltage Input</u>  Max. permissible capacitance between inputs lines (terminals 6 and 7): 1,200 pF  Load connectable in parallel with inputs (terminals 6 and 7).  • 100 to 240 VAC/100 to 125 VDC  High (logic) level: 85 to 264 VAC/85 to 137.5 VDC  Low (logic) level: 0 to 10 VAC/0 to 10 VDC  • 24 to 48 VAC/12 to 48 VDC  High (logic) level: 20.4 to 52.8 VAC/10.8 to 52.8 VDC  Low (logic) level: 0 to 2.4 VAC/0 to 1.2 VDC</p>
<b>Power consumption</b>	<p><u>H3CR-A/-A8</u>  • 100 to 240 VAC/100 to 125 VDC  (When at 240 VAC, 60 Hz)  Relay ON: approx. 2.0 VA (1.6 W) Relay OFF: approx. 1.3 VA (1.1 W)  • 24 to 48 VAC/12 to 48 VDC  (When at 24 VDC)  Relay ON: approx. 0.8 W Relay OFF: approx. 0.2 W</p> <p><u>H3CR-AP (See note 3)</u>  • 100 to 240 VAC/100 to 125 VDC  (When at 240 VAC, 60 Hz)  Relay ON: approx. 2.5 VA (2.2 W) (See note 4.) Relay OFF: approx. 1.8 VA (1.7 W) (See note 4.)  • 24 to 48 VAC/12 to 48 VDC  (When at 24 VDC)  Relay ON: approx. 0.9 W (See note 4.) Relay OFF: approx. 0.3 W (See note 4.)</p> <p><u>H3CR-A8E</u>  • 100 to 240 VAC/100 to 125 VDC  (When at 240 VAC, 60 Hz)  Relay ON/OFF: approx. 2 VA (0.9 W)  • 24 to 48 VAC/VDC  (When at 24 VDC)  Relay ON/OFF: approx. 0.9 W</p> <p><u>H3CR-AS/-A8S</u>  • 24 to 48 VAC/12 to 48 VDC  (When at 24 VDC)  Output ON: 0.3 W Output OFF: 0.2 W</p>
<b>Control outputs</b>	<ul style="list-style-type: none"> <li>Models with Contact Outputs  <u>H3CR-A/-A8/-AP</u>  5A at 250 VAC/30 VDC, 0.15A at 125 VDC, resistive load (<math>\cos\phi = 1</math>)  Minimum applied load: 10mA at 5 VDC (failure level: P reference value)  Contact materials: Ag-alloy</li> <li><u>H3CR-A8E</u>  5A at 250 VAC/30 VDC, 0.15A at 125 VDC, resistive load (<math>\cos\phi = 1</math>)  Minimum applied load: 10mA at 5 VDC (failure level: P reference value)  Contact materials: AgSnIn</li> <li>Transistor output: Open collector(NPN/PNP)  <u>H3CR-AS/-A8S</u>  100 mA max at 30 VDC max., residual voltage: 2 VDC max.</li> </ul>

**Note: 1.** DC ripple rate: 20% max. (A single-phase, full-wave-rectification power supply can be used).

**2.** Do not use an inverter output as the power supply. Refer to your OMRON website for details.

**3.** Models with 24-to-48-VAC or 12-to-48-VDC power supply have inrush current. Caution is thus required when turning ON and OFF power to the Timer with a non-contact output from a device such as a sensor. (Models with an inrush current of approximately 50 mA and a 24-VDC power supply are available (the H3CR-A-302 and H3CR-A8-302).)  
For details, consult your OMRON sales representative.

**4.** The values are for when the terminals 2 and 7 and terminals 10 and 6 are short-circuited, and include the consumption current of the input circuit.

**5.** Refer to your OMRON website when using the Timer together with a 2-wire AC proximity sensor.

**6.** For details, see *Input Connections: No-voltage Input Signal Levels* on page 11, and *Input Connections: Voltage Input Signal Levels* on page 12.

# H3CR-A

## ■ Characteristics

<b>Accuracy of operating time</b>	±0.2% FS max. (±0.2%±10 ms max. in a range of 1.2 s or 3 s)
<b>Setting error</b>	±5% FS ±50 ms (See note 1)
<b>Reset time</b>	Min. power-opening time: 0.1 s max. Min. pulse width: 0.05 s (H3CR-A/-AS)
<b>Reset voltage</b>	10% max. of rated supply voltage
<b>Influence of voltage</b>	±0.2% FS max. (±0.2%±10 ms max. in a range of 1.2 s or 3 s)
<b>Influence of temperature</b>	±1% FS max. (±1%±10 ms max. in a range of 1.2 s or 3 s)
<b>Insulation resistance</b>	100 MΩ min. (at 500 VDC)
<b>Dielectric strength</b>	2,000 VAC (1,000 VAC for H3CR-A□S), 50/60 Hz for 1 min (between current-carrying metal parts and exposed non-current-carrying metal parts) 2,000 VAC (1,000 VAC for H3CR-A□S), 50/60 Hz for 1 min (between control output terminals and operating circuit) 2,000 VAC, 50/60 Hz for 1 min (between contacts of different polarities) 1,000 VAC, 50/60 Hz for 1 min (between contacts not located next to each other) 2,000 VAC, 50/60 Hz for 1 min (between input and control output terminals and operation circuit) for H3CR-AP
<b>Impulse withstand voltage</b>	5 kV (between power terminals) for 100 to 240 VAC/100 to 125 VDC, 1 kV for 24 to 48 VAC/12 to 48 VDC 5 kV (between current-carrying terminal and exposed non-current-carrying metal parts) for 100 to 240 VAC/100 to 125 VDC, 1.5 kV for 24 to 48 VAC/12 to 48 VDC and 24 to 48 VAC/VDC
<b>Noise immunity</b>	±1.5 kV (between power terminals) and ±600 V (between no-voltage input terminals), square-wave noise by noise simulator (pulse width: 100 ns/1 μs, 1-ns rise)
<b>Static immunity</b>	Malfunction: 8 kV Destruction: 15 kV
<b>Vibration resistance</b>	Destruction: 10 to 55 Hz with 0.75-mm single amplitude each in 3 directions for 2 hours each Malfunction: 10 to 55 Hz with 0.5-mm single amplitude each in 3 directions for 10 minutes each
<b>Shock resistance</b>	Destruction: 1,000 m/s <sup>2</sup> 3 times each in 6 directions Malfunction: 100 m/s <sup>2</sup> 3 times each in 6 directions
<b>Ambient temperature</b>	Operating: -10°C to 55°C (with no icing) Storage: -25°C to 65°C (with no icing)
<b>Ambient humidity</b>	Operating: 35% to 85%
<b>Life expectancy</b>	Mechanical: 20,000,000 operations min. (under no load at 1,800 operations/h) Electrical: 100,000 operations min. (5 A at 250 VAC, resistive load at 1,800 operations/h) (See note 2)
<b>EMC</b>	(EMI) EN61812-1 Emission Enclosure: EN55011 Group 1 class A Emission AC Mains: EN55011 Group 1 class A (EMS) EN61812-1 Immunity ESD: IEC61000-4-2 Immunity RF-interference: IEC61000-4-3 Immunity Burst: IEC61000-4-4 Immunity Surge: IEC61000-4-5 Immunity Conducted Disturbance: IEC61000-4-6 Immunity Voltage Dip/Interruption: IEC61000-4-11
<b>Case color</b>	Light gray (Munsell 5Y7/1)
<b>Degree of protection</b>	IP40 (panel surface)
<b>Weight</b>	Approx. 90 g

- Note:**
1. The value is ±5% FS +100 ms to -0 ms max. when the C, D, or G mode signal of the H3CR-AP is OFF.
  2. Refer to the *Life-test Curve (Reference)*.
  3. Contact output only.

## ■ Life-test Curve (Reference)

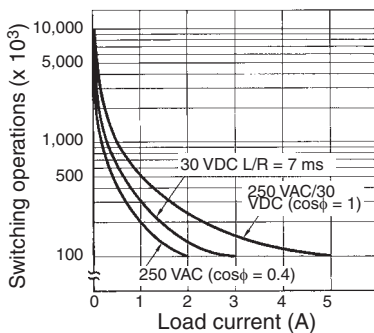

**Reference:** A maximum current of 0.15 A can be switched at 125 VDC ( $\cos\phi = 1$ ) and a maximum current of 0.1 A can be switched at 125V DC and L/R = 7ms. In both cases, a life of 100,000 operations can be expected. The minimum applicable load is 10 mA at 5 VDC (failure level: P).

# Connections

## ■ Block Diagrams

H3CR-A/-AS/-A-301

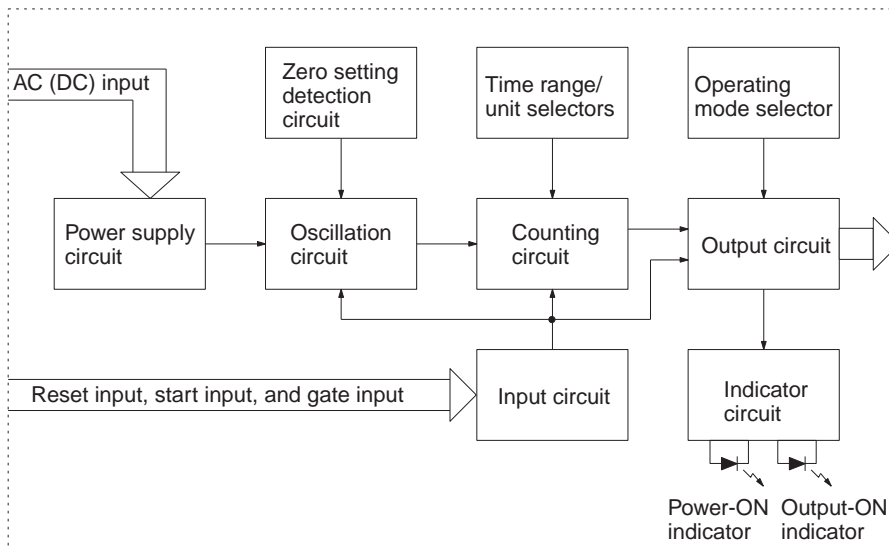

H3CR-AP

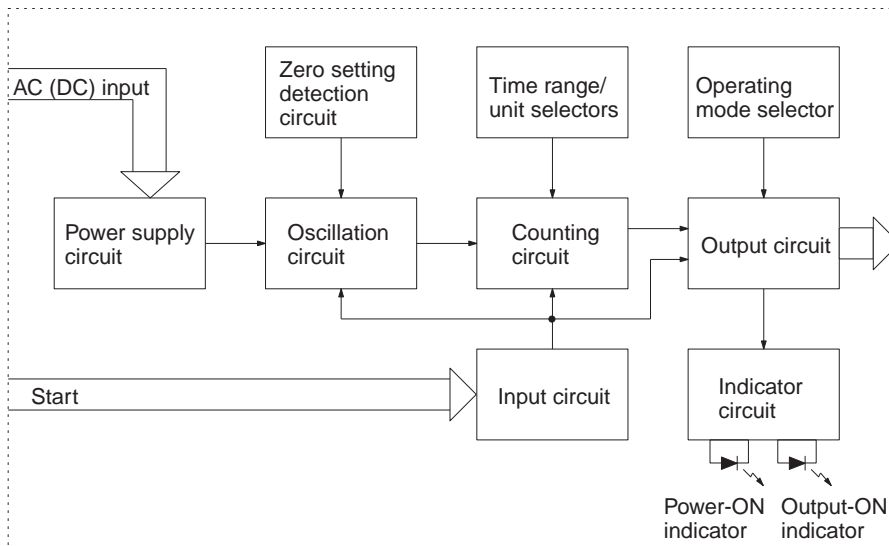



# H3CR-A

H3CR-A8/-A8S/A8-301

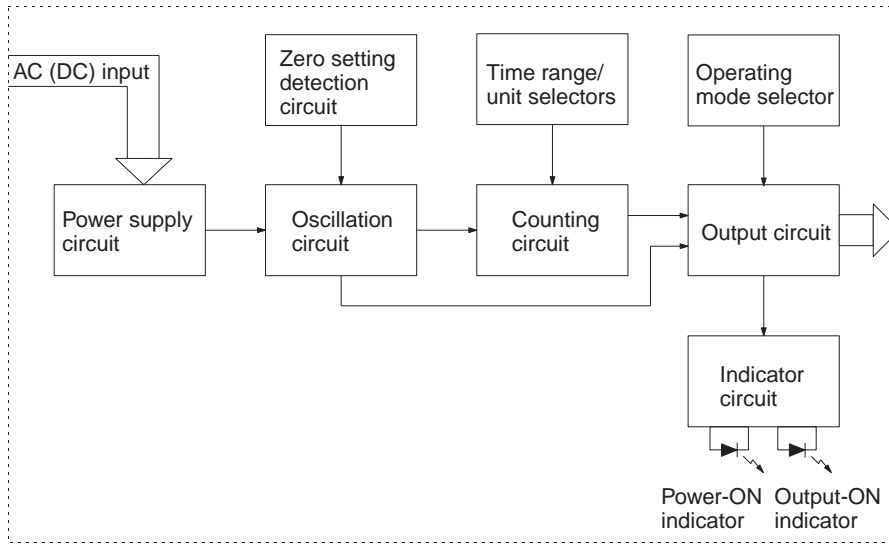

H3CR-A8E

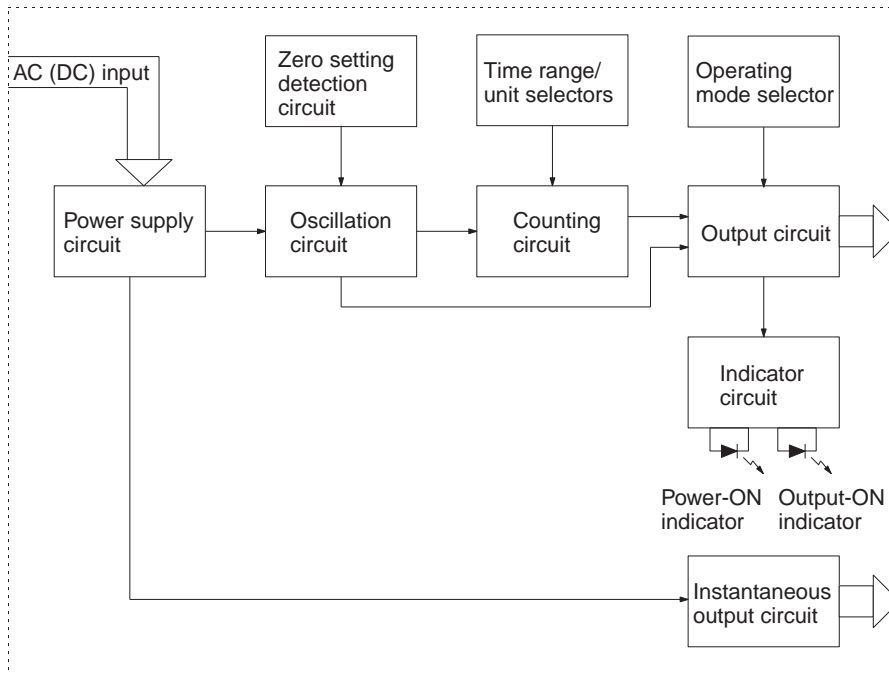

## ■ I/O Functions

Inputs (for -A/ -AS models)	Start	Starts time-measurement.
	Reset	Interrupts time-measurement and resets time-measurement value. Timing operation is stopped and the control output turns OFF (it is reset).
	Gate	The timing operation is interrupted while the gate input is active.
Outputs	Control output	Outputs are turned ON according to designated output mode when preset value is reached.

**Note:** H3CR-AP incorporates start input only.  
Models H3CR-A8/-A8E/-A8S/-A8-301 do not have an input function.

## Terminal Arrangement

**Note: 1.** The delayed contact of conventional Timers was indicated as 

The contact symbol of the H3CR-A is indicated as  because its operating mode is six multi-modes (four multi-modes for the H3CR-A8).

**2.** Do not use an empty terminal on the H3CR-AP/-AS/-A8S as a relay terminal or otherwise.

### 11-pin Models

**H3CR-A/-A-301 (Contact Output)**

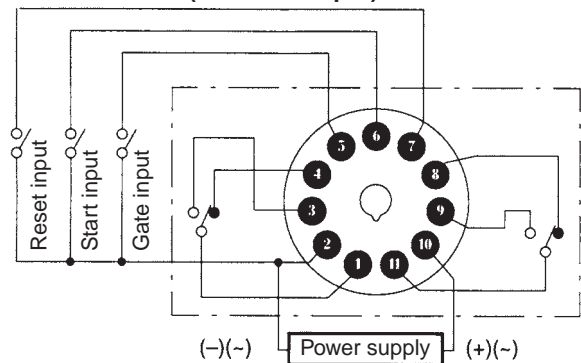

**H3CR-AS (Transistor Output)**

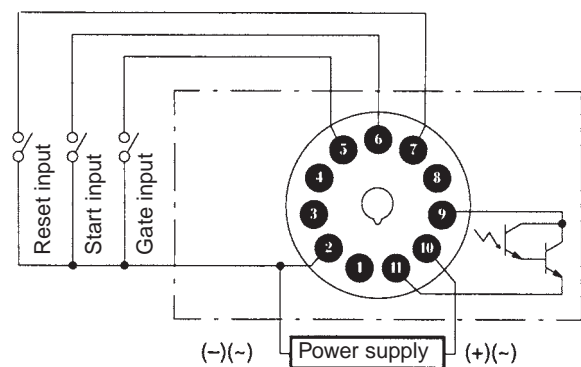

**Note:** Terminals 1, 3, 4, and 8 are empty. Terminals 2, 5, 6, 7, and 10 are the same as for the H3CR-A.

**H3CR-AP (Contact Output)**

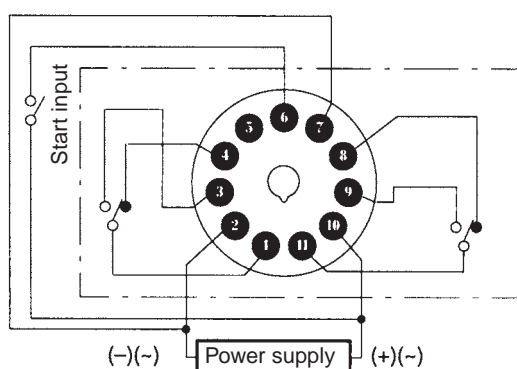

**Note: 1.** Terminal 5 is empty.  
**2.** Separate power supplies can be used for the Timer and inputs.

### 8-pin Models

**H3CR-A8/-A8-301 (Contact Output)**

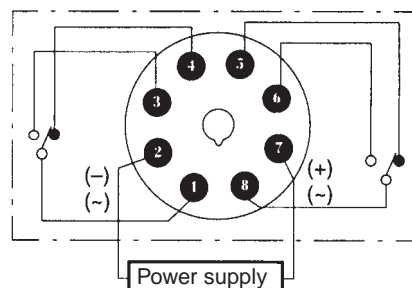

**H3CR-A8S (Transistor Output)**

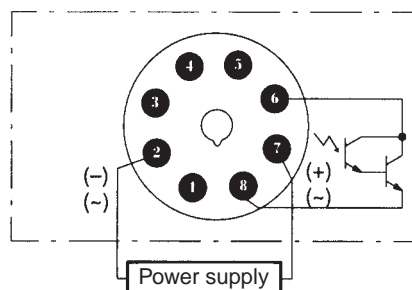

**Note:** Terminals 1, 3, 4, and 5 are empty. Terminals 2 and 7 are the same as for the H3CR-A8.

**H3CR-A8E (Contact Output)**

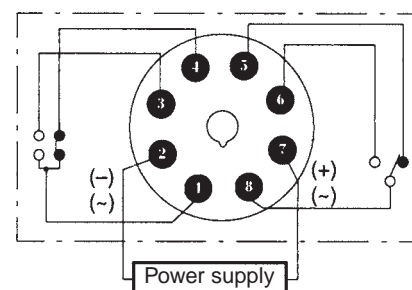

# H3CR-A

## Input Connections

### H3CR-A/-AS/-A-301

The inputs of the H3CR-A/-AS/-A-301 are no-voltage (short-circuit or open) inputs.

#### No-voltage Inputs

##### No-contact Input

(Connection to NPN open collector output sensor.)

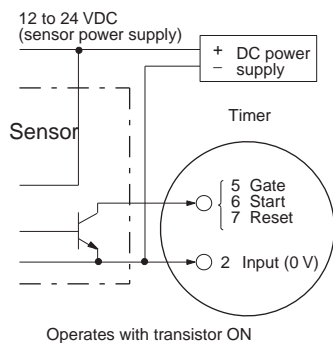

##### Contact Input

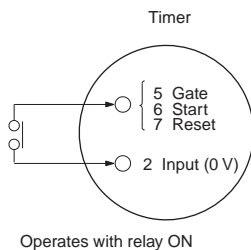

##### No-contact Input

(Connection to a voltage output sensor.)

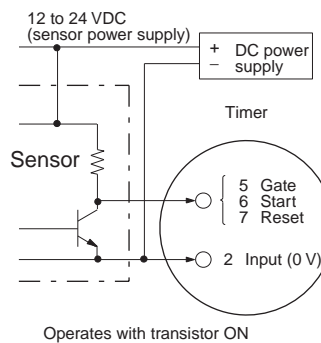

#### No-voltage Input Signal Levels

No-contact input	1. Short-circuit level Transistor ON Residual voltage: 1 V max. Impedance when ON: 1 k $\Omega$ max.
	2. Open level Transistor OFF Impedance when OFF: 100 k $\Omega$ min.
Contact input	Use contacts which can adequately switch 0.1 mA at 5 V

## H3CR-AP

The start input of the H3CR-AP is voltage input. (Voltage imposition or open)

### Voltage Inputs

#### No-contact Input

(Connection to PNP open collector output sensor)

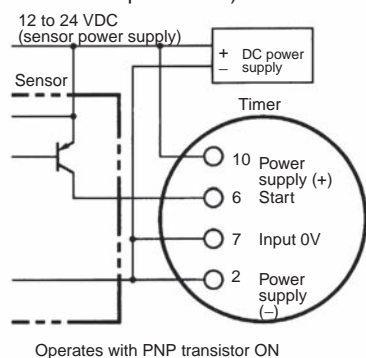

#### No-contact Input

(Connection to NPN open collector output sensor)

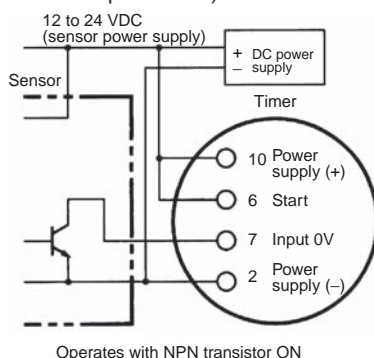

#### Contact Input

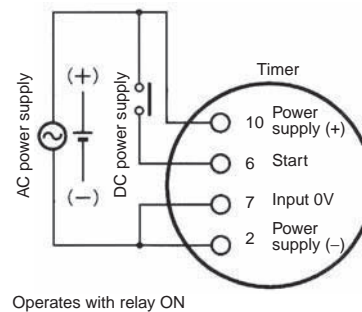

**Note:** The input circuit is isolated from the power supply circuit. Thus, an NPN transistor can be connected.

**Note:** Refer to the signal levels in the following table and be aware of the minimum applicable load of the relay.

**Note:** Before making connections, refer to *Safety Precautions (H3CR-□)*.

### Voltage Input Signal Levels

No-contact input	1. Transistor ON Residual voltage: 1 V max. The voltage between terminals 6 and 7 must be 10.8 VDC min.
	2. Transistor OFF Leakage current: 0.01 mA max. The voltage between terminals 6 and 7 must be 1.2 VDC max.
Contact input	Use contacts that can adequately switch 0.1 mA at each operating voltage. The voltage between terminals 6 and 7 with contacts ON or OFF must satisfy the specified value.  Contacts ON 100-to-240-VAC and 100-to-125-VDC models: 85 to 264 VAC or 85 to 137.5 VDC 24-to-48-VAC and 12-to-48-VDC models: 20.4 to 52.8 VAC or 10.8 to 52.8 VDC  Contacts OFF 100-to-240-VAC and 100-to-125-VDC models: 0 to 10 VAC or 0 to 10 VDC 24-to-48-VAC and 12-to-48-VDC models: 0 to 2.4 VAC or 0 to 1.2 VDC

# Operation

## ■ Timing Chart (Refer to page 20 for application examples.)

### H3CR-A/-AS/-AP\*/-A-301

Operating mode	Timing chart	
A: ON-delay		<p><b>Basic operation</b></p> <p><b>Note:</b> Start input is invalid while the Timer is in operation.</p>
B: Flicker OFF start		<p><b>Basic operation</b></p> <p><b>Note:</b> Start input is invalid while the Timer is in operation.</p>
B2: Flicker ON start		<p><b>Basic operation</b></p> <p><b>Note:</b> Start input is invalid while the Timer is in operation.</p>
C: Signal ON/OFF-delay		<p><b>Basic operation</b></p> <p><b>Note:</b> Start input is valid and retriggerable while the Timer is in operation.</p>

- Note:**
1. Allow at least 0.1 s for the Timer reset time if the power supply is reset due to an interruption in the power supply.
  2. The minimum input pulse width (for start, reset) is 0.05 s.
  3. The letter "t" in the timing charts indicates the set time, and "t-a" means that the period is less than the set time. ( $t - a < 1$ )
  4. H3CR-AP model incorporates start input only.
  5. Model H3CR-AS only has operation equivalent to time-limit contact: NO.
  6. When the setting dial is turned all the way past 0 for instantaneous output, "t" (set time) in the above time chart is 0-sec operation.

Operating mode	Timing chart	
<b>D:</b> Signal OFF-delay		<div style="border: 1px solid black; padding: 2px; display: inline-block;">Basic operation</div>  <b>Note:</b> Start input is valid and retriggerable while the Timer is in operation.
<b>E:</b> Interval		<div style="border: 1px solid black; padding: 2px; display: inline-block;">Basic operation</div>  <b>Note:</b> Start input is valid and retriggerable while the Timer is in operation. (Previous start input will be cancelled.)
<b>G:</b> Signal ON/ OFF-delay		<div style="border: 1px solid black; padding: 2px; display: inline-block;">Basic operation</div>  <b>Note:</b> Start input is valid and retriggerable while the Timer is in operation.
<b>J:</b> One-shot output		<div style="border: 1px solid black; padding: 2px; display: inline-block;">Basic operation</div>  <b>Note:</b> Start input is valid and retriggerable while the Timer is in operation. (Previous start input will be cancelled.)

**Gate Signal Input** (This timing chart indicates the gate input in operating mode A (ON-delay operation).)

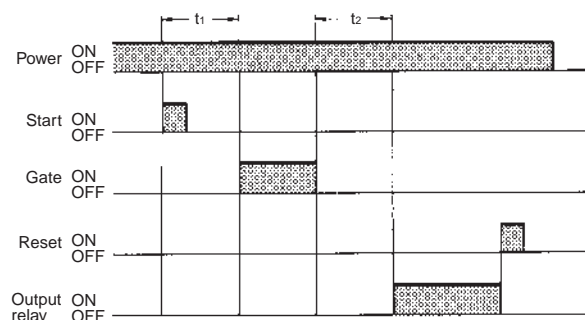

- Note:**
1. Allow at least 0.1 s for the Timer reset time if the power supply is reset due to an interruption in the power supply.
  2. The minimum input pulse width (for start, reset) is 0.05 s.
  3. The letter "t" in the timing charts indicates the set time, and "t-a" means that the period is less than the set time. (t - a < 1)
  4. In J Mode, there will be only one output even if the start input is longer than the set time.
  5. H3CR-AP model incorporates start input only.
  6. Model H3CR-AS only has operation equivalent to time-limit contact: NO.
  7. When the setting dial is turned all the way past 0 for instantaneous output, "t" (set time) in the above time chart is 0-sec operation.

**Note:** The set time is the sum of t1 and t2.  
Start and reset are also both enabled when the gate signal is ON.

# H3CR-A

## H3CR-A8/-A8S/-A8-301

Operating mode	Timing chart	
<b>A:</b> ON-delay		<div style="border: 1px solid black; padding: 2px; display: inline-block;">Basic operation</div> 
<b>B:</b> Flicker OFF start		<div style="border: 1px solid black; padding: 2px; display: inline-block;">Basic operation</div> 
<b>B2:</b> Flicker ON start		<div style="border: 1px solid black; padding: 2px; display: inline-block;">Basic operation</div> 
<b>E:</b> Interval		<div style="border: 1px solid black; padding: 2px; display: inline-block;">Basic operation</div> 
<b>J:</b> One-shot output		<div style="border: 1px solid black; padding: 2px; display: inline-block;">Basic operation</div> 

**Note: 1.** Allow a timer reset time ( $R_t$ ) of 0.1 s or longer.

**2.** The letter "t" in the timing charts indicates the set time, and "t-a" means that the period is less than the set time. ( $t - a < 1$ )

**3.** Model H3CR-A8S only has operation equivalent to time-limit contact: NO.

**4.** When the setting dial is turned all the way past 0 for instantaneous output, "t" (set time) in the above time chart is 0-sec operation.

**5.** You can use J Mode to use the power supply as the start input.

H3CR-A8E

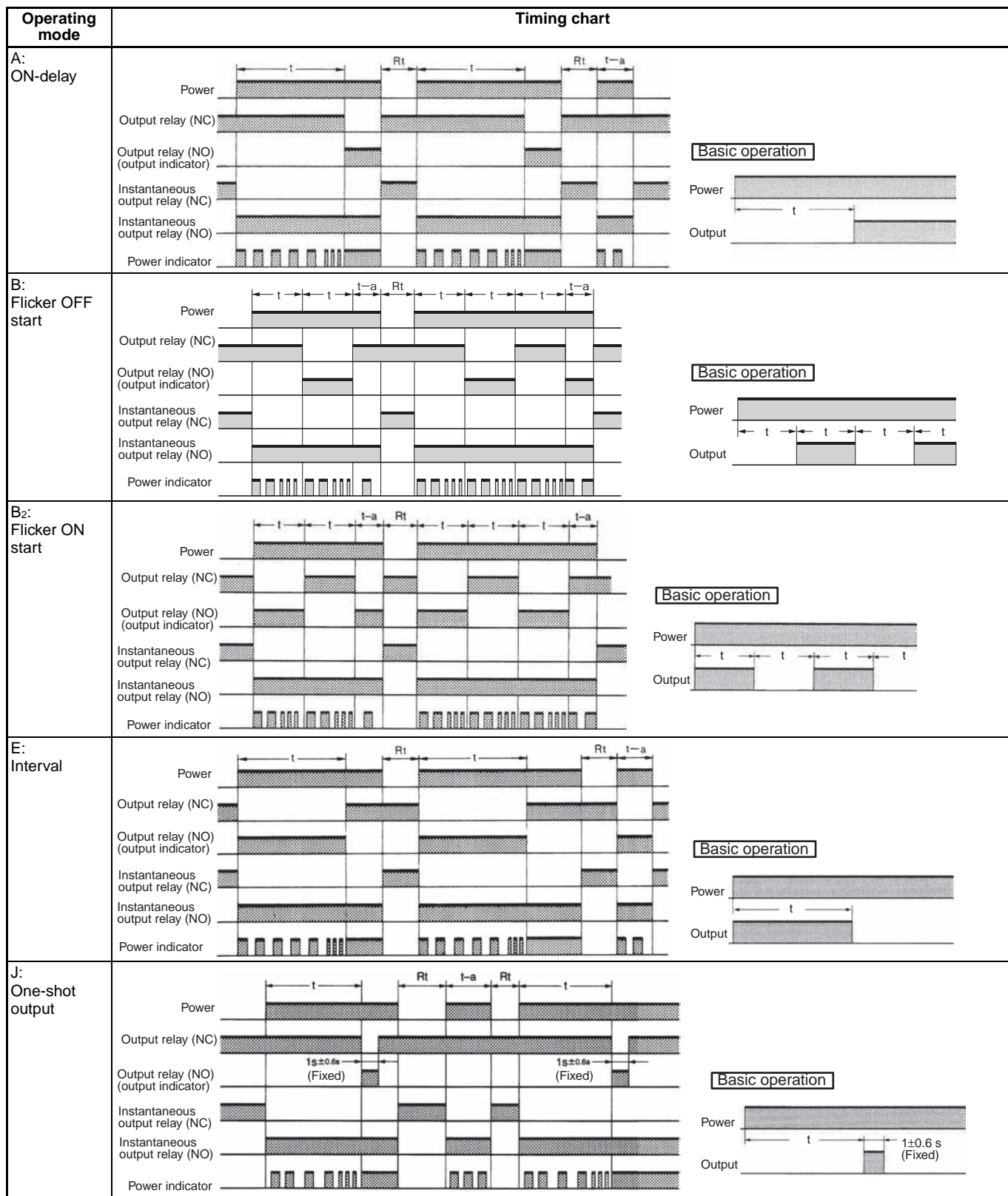

Note: Refer to page 14.



# Nomenclature

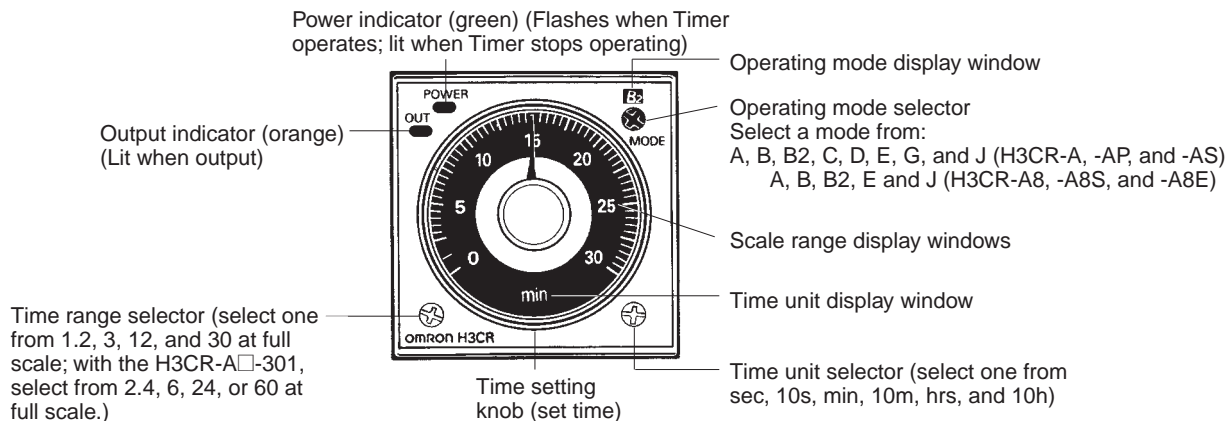

Scale range display windows changes as below by turning the Time range selector clockwise.\*

0	0.2	0.4	0.6	0.8	1.0	1.2
0	0.5	1	1.5	2	2.5	3
0	2	4	6	8	10	12
0	5	10	15	20	25	30

\* On the H3CR-A□-301 type, the time is twice as long.

# Dimensions

Note: All units are in millimeters unless otherwise indicated.

H3CR-A  
H3CR-AP  
H3CR-AS  
H3CR-A-301

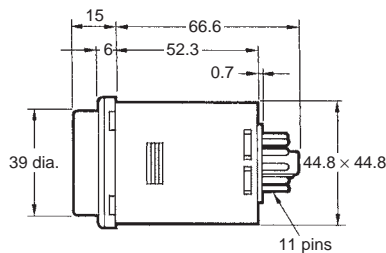
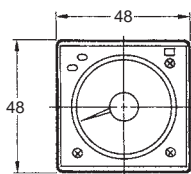
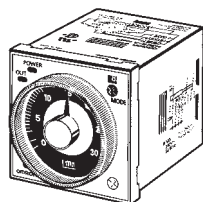

H3CR-A8  
H3CR-A8S  
H3CR-A8E  
H3CR-A8-301

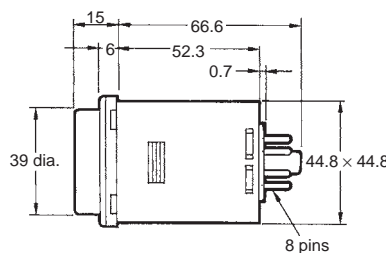
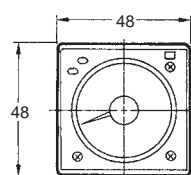
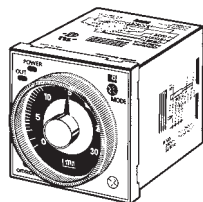

Dimensions with Set Ring  
Y92S-27/-28 (Order Separately)

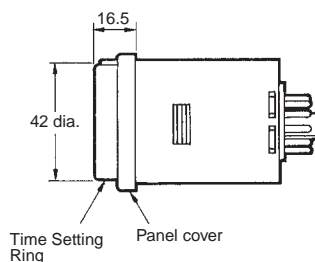
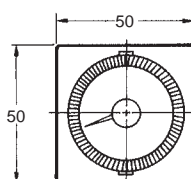
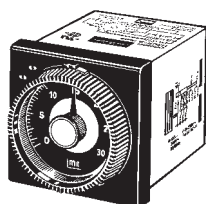

Dimensions with Front Connecting Socket  
P2CF-08-□/P2CF-11-□

Dimensions with Back Connecting Socket  
P3G-08/P3GA-11

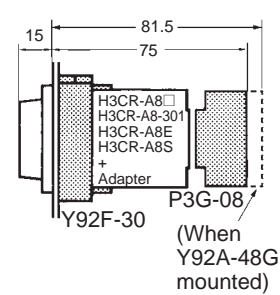
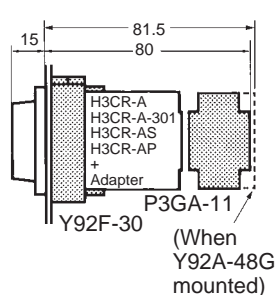
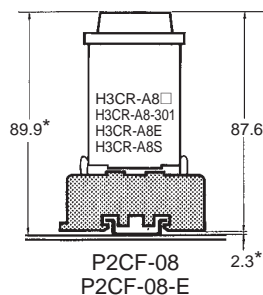
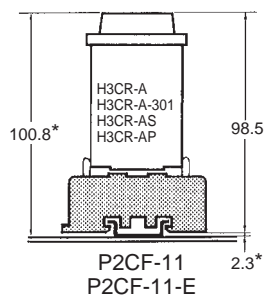

Note: There are no restrictions to the mounting direction.  
\* These dimensions vary with the kind of DIN track (reference value).

## H3CR-A

### ■ Accessories (Order Separately)

#### Protective Cover

##### Y92A-48B

To use the Protective Cover with a flush mounting, use the Y92F-30 flush mounting adaptor.

This Protective Cover cannot be used together with the Y92F-73/-74 flush mounting adaptor or the panel cover.

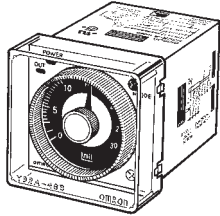

#### Hold-down Clip

##### Y92H-8

The Y92H-8 Hold-down Clip is attached to the PF085A socket.

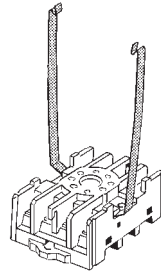

##### Y92H-7

Y92H-7 Hold-down Clip is attached with screws together with the PL08 socket or the PL11 socket.

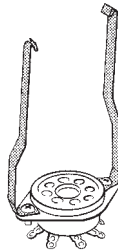

# Application Examples (H3CR-A)

## A Mode: ON-delay

ON-delay operation (A mode) is a basic mode.

### 1. Power-ON Start/Power-OFF Reset

The Power-ON start/Power-OFF reset operation is a standard operating method.

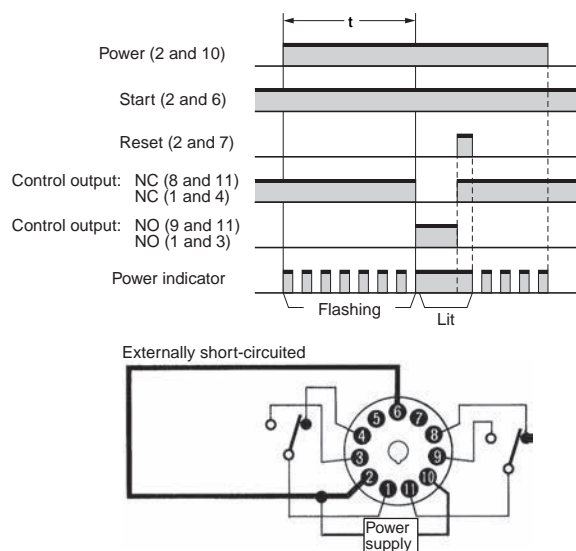

### 2. Signal Start/Signal Reset

The Signal start/Signal reset operation is useful for remote control of the Timer.

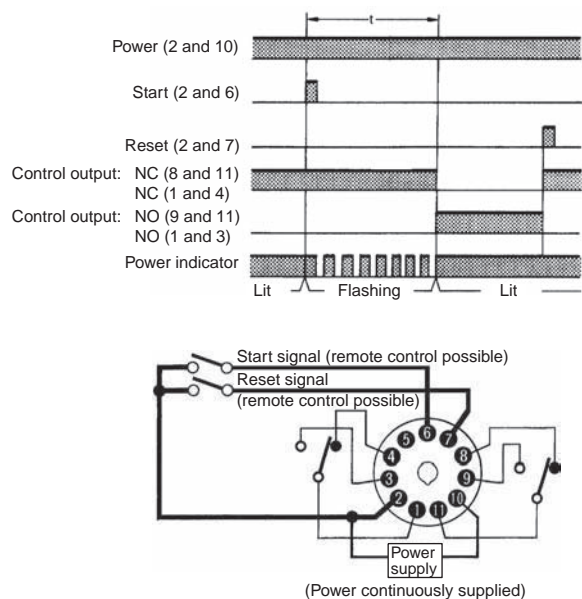

### 3. Control of Integrated Time with Gate Signal

Gate signal processing (during input or a temporary timing stop) is possible with both power start and signal start.

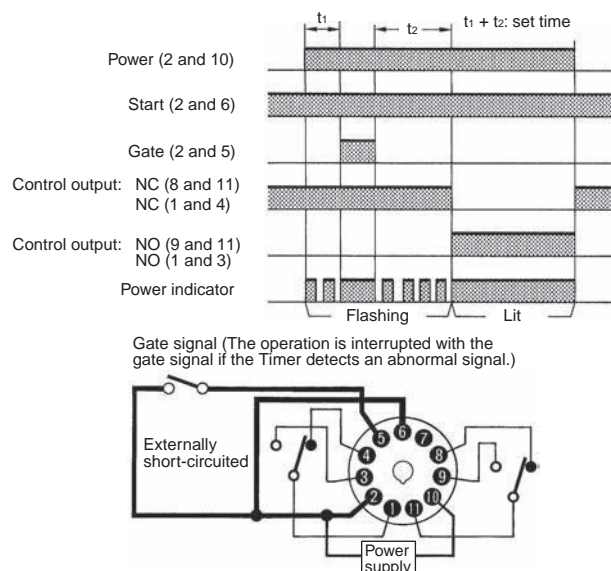

## B/B2 Mode: Flicker

The flicker operation in the B and B2 modes can be effectively applied to lamp or buzzer (ON and OFF) alarms or the monitoring of an intermittent operation with a display.

### 1. Power-ON Start/Power-OFF Reset (in B Mode)

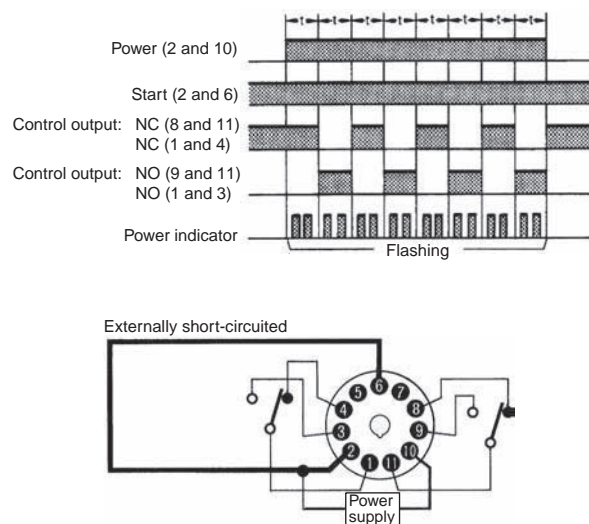

# H3CR-A

## 2. Signal Start/Signal Reset (in B Mode)

If there is an abnormal signal, flashing starts. When the abnormal condition is restored, a reset signal stops the display flashing.

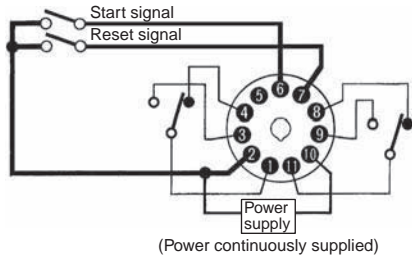
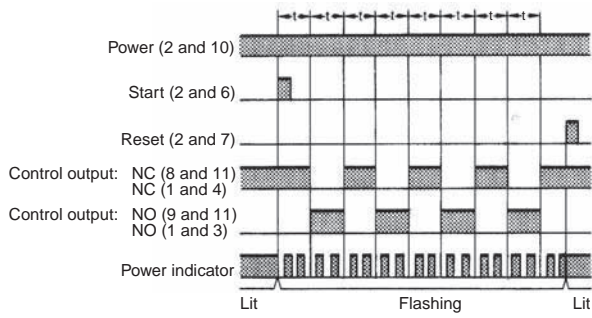

## 2. Signal-ON-OFF Start/Instantaneous Operation/Time-limit Reset

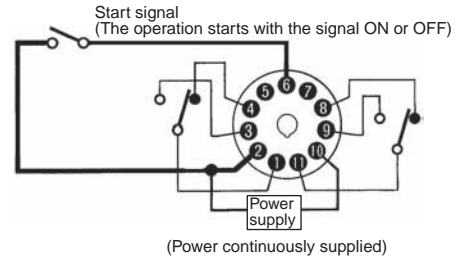
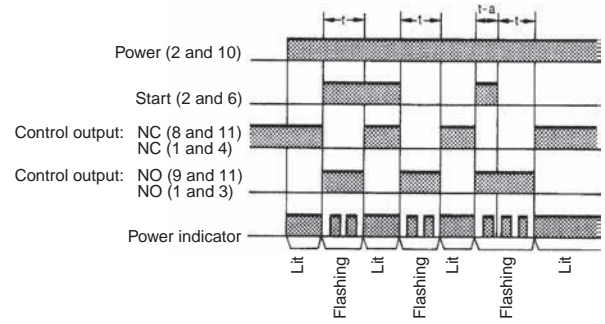

## C Mode: Signal ON/OFF-delay

The Signal ON-/OFF-delay operation (C mode) is useful for the control of distribution of products on a production line into boxes by the specified number or time.

### 1. Power-ON Start/Instantaneous Operation/Time-limit Reset

A set of these functions is useful for the operation of a machine for a specified period when power is ON.

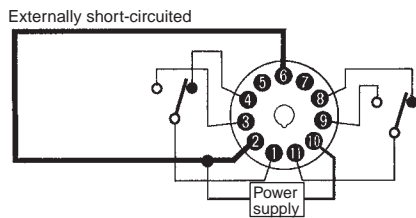
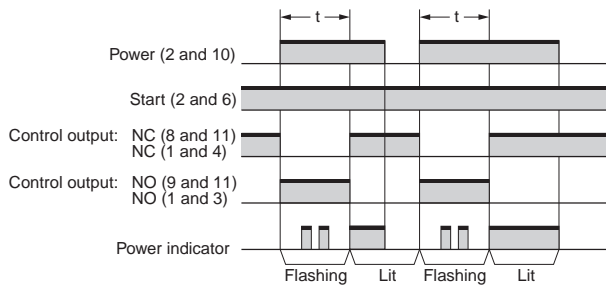

## D Mode: Signal OFF-delay

Signal OFF-delay operation (D mode) can be effectively used to keep a load operating for a certain period. For example, this function enables the cooling fan for a lamp or heater to operate for a certain period after the lamp or heater is switched OFF.

### 1. Power-ON Start/Instantaneous Operation/Time-limit Reset

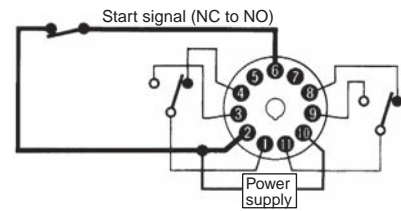
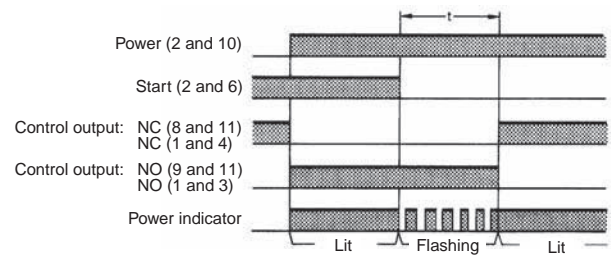

## 2. Signal Start/Instantaneous Operation/ Time-limit Reset

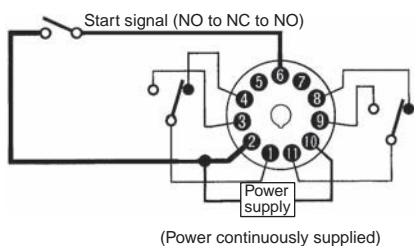
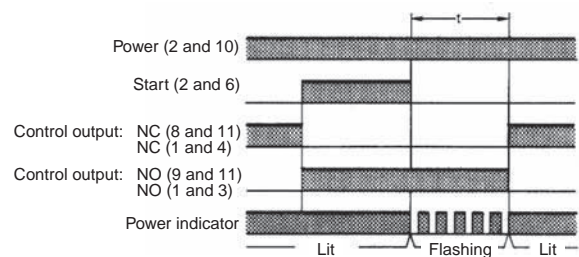

## 2. Signal Start/Instantaneous Operation/ Time-limit Reset

This function is useful for the repetitive control such as the filling of liquid for a specified period after each Signal start input.

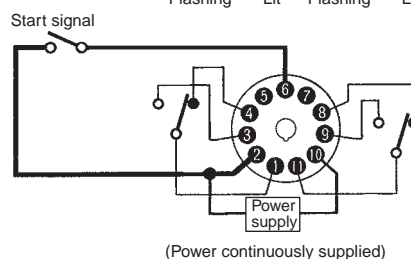
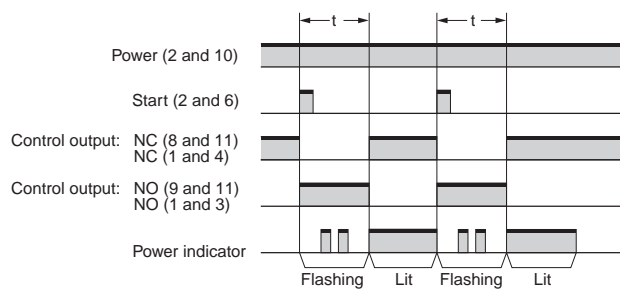

## E Mode: Interval

### 1. Power-ON Start/Instantaneous Operation/ Time-limit Reset

This function is useful for the operation of a machine for a specified period after power is ON.

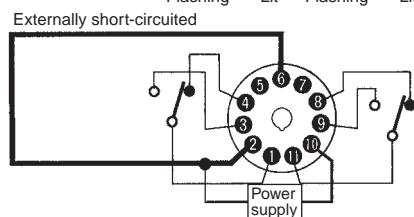
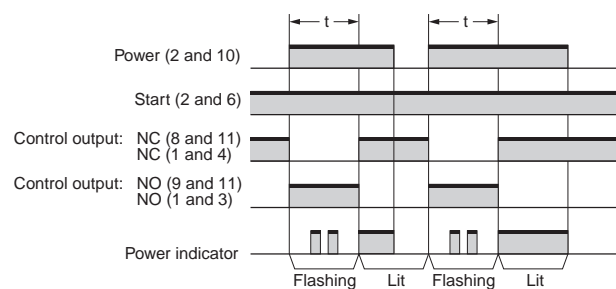

# Safety Precautions (H3CR-A)

Refer to *Safety Precautions for All Timers*.

**Note:** The following precautions apply to all H3CR-A models.

## Power Supplies

For the power supply of an input device of the H3CR-A use an isolating transformer with the primary and secondary windings mutually isolated and the secondary winding not grounded.

**Correct**

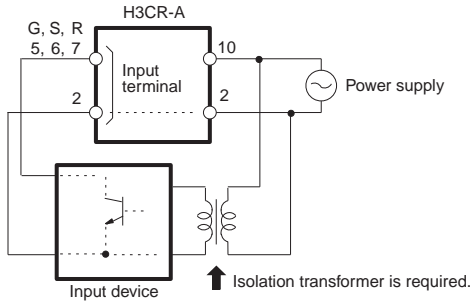

**Incorrect**

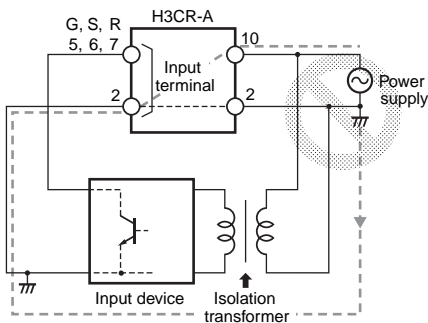

The H3CR-A's power supply terminal 2 is a common terminal for input signals to the Timer. Do not disconnect the wires on terminal 2, otherwise the internal circuitry of the Timer will be damaged.

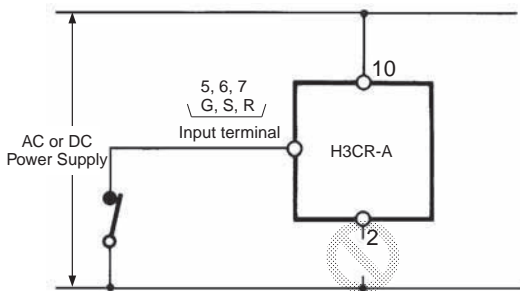

## Input/Output

### Relationship between Input and Power Supply Circuits (except for H3CR-A8E)

The H3CR-A (except for H3CR-A8E) uses transformerless power supply. When connecting a relay or transistor as an external input device, pay attention to the following points to prevent short-circuiting due to a sneak current to the transformerless power supply. If a relay or transistor is connected to two or more Timers, the input terminals of those Timers must be wired properly so that they will not differ in phase, otherwise the terminals will be short-circuited to one another.

**Incorrect**

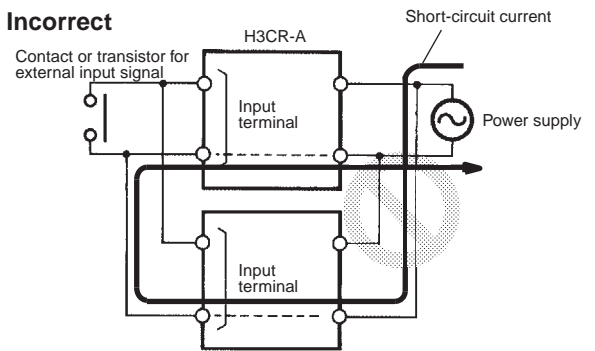

**Correct**

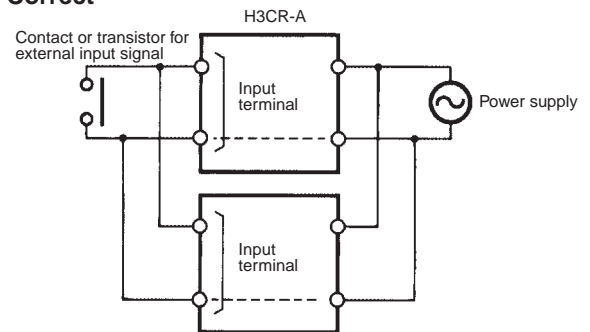

It is impossible to provide two independent power switches as shown below regardless of whether or not the Timers are different in phase.

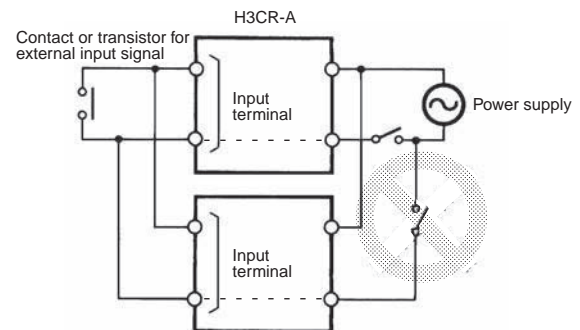

## Relationship between Input and Power Supply Circuits (H3CR-A□/-A□S)

An appropriate input is applied to the input signal terminals of the H3CR-A□/-A□S when one of the input terminals is short-circuited with the common terminal (terminal 2) for the input signals. Never use terminal 10 as the common terminal for this purpose, otherwise the internal circuit of the Timer will be damaged.

**Correct**

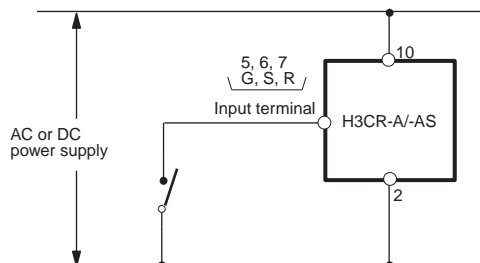

**Incorrect**

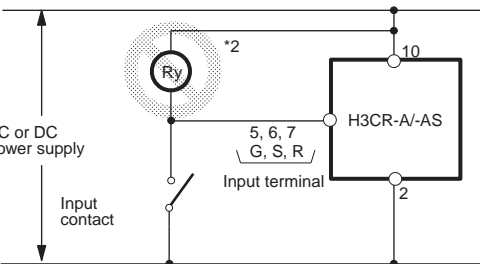
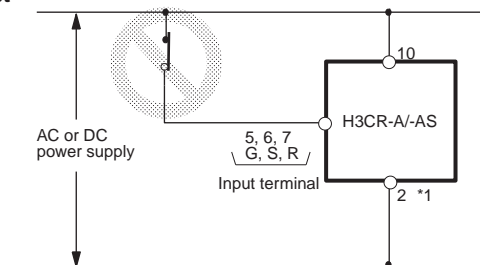

- \*1 Power terminal 2 is a common terminal that is also used for the input signal. Do not use terminal 10 as a common terminal as this will damage the internal circuitry.
- \*2 If a relay or other load is connected here, high voltage will be applied to the input terminal and damage the internal circuitry.
- The transistor output of the H3CR-A□S is isolated from the internal circuitry by a photocoupler, and can therefore be used either as an NPN output type or a PNP (equivalent) output type.

## Relationship between Input and Power Supply Circuits (H3CR-AP)

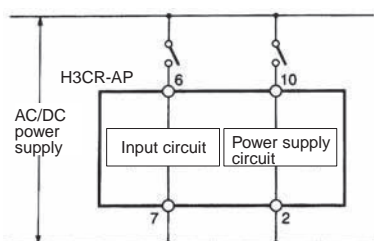

Since the input circuit and the power supply circuit are configured independently, the input circuit can be turned ON or OFF irrespective of the ON/OFF state of the power supply. It must be noted that a voltage equivalent to the power supply voltage is applied to the input circuit.

If a relay or transistor is connected to two or more Timers, the input terminals of those Timers must be wired properly so that they will not be different in phase or the terminals will be short-circuited to one another (refer to the figures below).

**Incorrect**

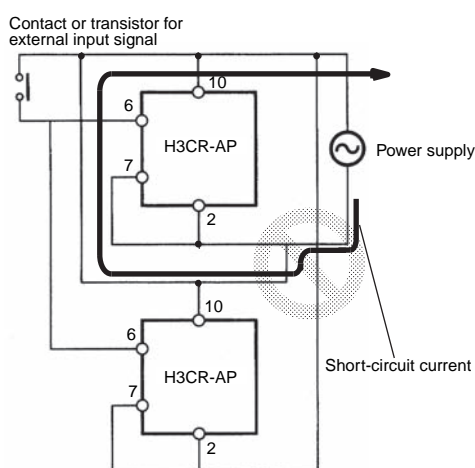

**Correct**

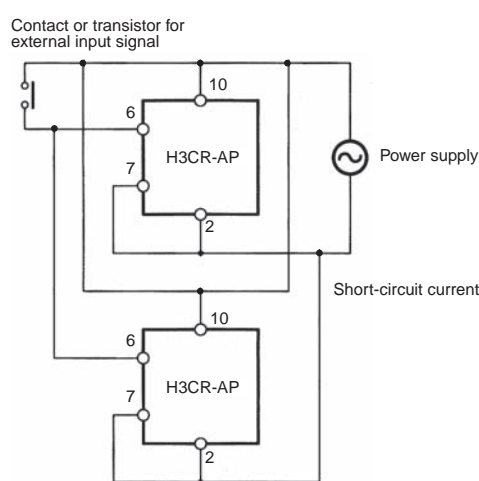

When using the timer in an environment where considerable noise occurs, keep the input signal source device, timer unit, and wiring as far away as possible from the source of the noise. It is also recommended that shielded wire be used for the input signal wiring as a countermeasure for noise.

## Common to All H3CR-A Models

With the H3CR-AP, input wires must be as short as possible. If the floating capacity of wires exceeds 1,200 pF (approx. 10 m for cables with 120 pF/m), the operation will be affected. Pay particular attention when using shielded cables.

The H3CR-A□S transistor output is isolated from the internal circuitry by a photocoupler. Therefore, either NPN or PNP output is possible.

ALL DIMENSIONS SHOWN ARE IN MILLIMETERS.

To convert millimeters into inches, multiply by 0.03937. To convert grams into ounces, multiply by 0.03527.

In the interest of product improvement, specifications are subject to change without notice.



**MEMO**

# Solid-state Twin Timers

## H3CR-F

### DIN 48 × 48-mm Twin Timers

- Wide power supply ranges of High Voltage 100 to 240 VAC/100 to 125 VDC and Low Voltage 24 to 48 VAC/12 to 48 VDC.
- ON- and OFF-times can be set independently and so combinations of long ON- or OFF-time and short OFF- or ON-time settings are possible.
- Twenty-four time ranges from 0.05 s to 300 h depending on the model to be used.
- Models with a flicker ON start or flicker OFF start are available.
- Easy sequence checks through instantaneous outputs for a zero set value at any time range.
- Length, when panel-mounted with a Socket, of 80 mm or less.
- 11-pin and 8-pin models are available.



For the most recent information on models that have been certified for safety standards, refer to your OMRON website.

## Model Number Structure

### Model Number Legend

H3CR - F    -

1 2 3 4 5

#### 1. Classification

F: Twin timers

#### 2. Configuration

None: 11-pin socket

8: 8-pin socket

#### 3. Twin Timer Mode

None: Flicker OFF start

N: Flicker ON start

#### 4. Time Range

None: 0.05 s to 300 h models

#### 5. Supply Voltage

100-240AC/100-125DC: 100 to 240 VAC/100 to 125 VDC

24-48AC/12-48DC: 24 to 48 VAC/12 to 48 VDC

## Ordering Information

### List of Models

Operating modes	Supply voltage	0.05 s to 300 h models	
		11-pin models	8-pin models
Flicker OFF start	100 to 240 VAC/100 to 125 VDC	H3CR-F 100-240AC/100-125DC	H3CR-F8 100-240AC/100-125DC
	24 to 48 VAC/12 to 48 VDC	H3CR-F 24-48AC/12-48DC	H3CR-F8 24-48AC/12-48DC
Flicker ON start	100 to 240 VAC/100 to 125 VDC	H3CR-FN 100-240AC/100-125DC	H3CR-F8N 100-240AC/100-125DC
	24 to 48 VAC/12 to 48 VDC	H3CR-FN 24-48AC/12-48DC	H3CR-F8N 24-48AC/12-48DC

**Note:** Specify both the model number and supply voltage when ordering.

Example: H3CR-F 100-240AC/100-125DC

\_\_\_\_\_ Supply voltage

## H3CR-F

### ■ Accessories (Order Separately)

#### Adapter, Protective Cover and Hold-down Clip

Name/specifications		Models
Flush Mounting Adapter		Y92F-30
		Y92F-73 *1
		Y92F-74 *1
Protective Cover		Y92A-48B *2
Hold-down Clip (Sold in sets of two)	For PF085A Socket	Y92H-8
	For PL08 or PL11 Sockets	Y92H-7

**Note:** Refer to Operation (Common) datasheet for details.

\*1 The Y92A-48B Protective Cover and the Y92F-73/-74 Flush Mounting Adapter cannot be used at the same time.

\*2 The Y92A-48B Protective Cover is made from hard plastic.

Remove the Protective Cover to change the set value.

The Y92A-48B Protective Cover and the Y92F-73/-74 Flush Mounting Adapter also cannot be used at the same time.

#### Sockets

Timer Pin	Round Sockets		
	Connection	Terminal	Models
11-pin	Front Connecting	DIN track mounting	P2CF-11
		DIN track mounting (Finger-safe type)	P2CF-11-E
	Back Connecting	Screw terminal	P3GA-11
		Solder terminal	PL11
		Wrapping terminal	PL11-Q
PCB terminal	PLE11-0		
8-pin	Front Connecting	DIN track mounting	P2CF-08
		DIN track mounting (Finger-safe type)	P2CF-08-E
		DIN track mounting	PF085A
	Back Connecting	Screw terminal	P3G-08
		Solder terminal	PL08
		Wrapping terminal	PL08-Q
		PCB terminal	PLE08-0

**Note: 1.** The P2CF-□□-E has a finger-protection structure. Round crimp terminals cannot be used. Use forked crimp terminals.

**2.** The P3GA-11 and P3G-08 Socket can be used together with the Y92A-48G Terminal Cover to implement finger protection.

**3.** For details, refer to your OMRON website.

#### Terminal Cover

Application	Model	Remarks
For back connecting socket	Y92A-48G	For P3G-08 and P3GA-11

**Note:** For details, refer to your OMRON website.

# Specifications

## ■ General

Item	H3CR-F	H3CR-F8	H3CR-FN	H3CR-F8N
Operating mode	Flicker OFF start		Flicker ON start	
Pin type	11-pin	8-pin	11-pin	8-pin
Operating/Reset method	Time-limit operation/Time-limit reset or self-reset			
Output type	Relay output (DPDT)			
Mounting method	DIN track mounting, surface mounting, and flush mounting			
Approved standards	UL508, CSA C22.2 No.14, NK, Lloyds, CCC Conforms to EN61812-1 and IEC60664-1 (VDE0110) 4kV/2. Output category according to EN60947-5-1.			

**Note:** For details, refer to your OMRON website.

## ■ Time Ranges

Time unit		s (sec)	×10 s (10 sec)	min (min)	×10 min (10 min)	h (hrs)	×10 h (10 hrs)
Fullscale setting	1.2	0.05 to 1.2	1.2 to 12	0.12 to 1.2	1.2 to 12	0.12 to 1.2	1.2 to 12
	3	0.3 to 3	3 to 30	0.3 to 3	3 to 30	0.3 to 3	3 to 30
	12	1.2 to 12	12 to 120	1.2 to 12	12 to 120	1.2 to 12	12 to 120
	30	3 to 30	30 to 300	3 to 30	30 to 300	3 to 30	30 to 300

**Note:** The times that can be set are given. When the time setting knob is turned below "0" until the point where the time setting knob stops, the output will operate instantaneously at all time range settings.  
For details, refer to your OMRON website.

## ■ Ratings

Rated supply voltage (See notes 1, 2, and 3.)	<ul style="list-style-type: none"> <li>• 100 to 240 VAC 50/60 Hz/100 to 125 VDC</li> <li>• 24 to 48 VAC 50/60 Hz/12 to 48 VDC</li> </ul>
Operating voltage range	85% to 110% of rated supply voltage; 90% to 110% with 12-VDC models
Power reset	Minimum power-opening time: 0.1 s
Power consumption	100 to 240 VAC: approx. 10 VA (2.1 W) at 240 VAC 24 VAC/VDC: approx. 2 VA (1.7 W) at 24 VAC approx. 1 W at 24 VDC
Control outputs	Contact output: 5 A at 250 VAC/30 VDC, resistive load ( $\cos\phi = 1$ ) The minimum applicable load is 10mA at 5VDC (P reference value). Contact materials : Ag-alloy

**Note:** 1. A power supply with a ripple of 20% max. (single-phase power supply with full-wave rectification) can be used with each DC Model.  
2. Do not use an inverter output as the power supply. Refer to your OMRON website for details.  
3. Refer to your OMRON website when using the Timer together with a 2-wire AC proximity sensor.

# H3CR-F

## ■ Characteristics

<b>Accuracy of operating time</b>	±0.2% FS max. (±0.2% FS ±10 ms max. in ranges of 1.2 and 3 s)
<b>Setting error</b>	±5% FS ±50 ms max.
<b>Reset time</b>	0.1 s max.
<b>Reset voltage</b>	10% max. of rated voltage
<b>Influence of voltage</b>	±0.2% FS max. (±0.2% FS ±10 ms max. in ranges of 1.2 and 3 s)
<b>Influence of temperature</b>	±1% FS max. (±1% FS ±10 ms max. in ranges of 1.2 and 3s)
<b>Insulation resistance</b>	100 MΩ min. (at 500 VDC)
<b>Dielectric strength</b>	2,000 VAC, 50/60 Hz for 1 min (between current-carrying metal parts and exposed non-current-carrying metal parts) 2,000 VAC, 50/60 Hz for 1 min (between control output terminals and operating circuit) 2,000 VAC, 50/60 Hz for 1 min (between contacts of different polarities) 1,000 VAC, 50/60 Hz for 1 min (between contacts not located next to each other)
<b>Impulse withstand voltage</b>	5kV (between power terminals), however, 1kV for 24 to 48VAC, 12 to 48 VDC 5kV (between current-carrying terminal and exposed non-current-carrying metal parts), however 1.5 kV for 24 to 48 VAC, 12 to 48 VDC
<b>Noise immunity</b>	±1.5 kV (between power terminals), square-wave noise by noise simulator (pulse width: 100 ns/1 μs, 1-ns rise)
<b>Static immunity</b>	Malfunction: 8 kV Destruction: 15 kV
<b>Vibration resistance</b>	Destruction: 10 to 55 Hz with 0.75-mm single amplitude for 2 hrs each in three directions Malfunction: 10 to 55 Hz with 0.5-mm single amplitude for 10 min each in three directions
<b>Shock resistance</b>	Destruction: 980 m/s <sup>2</sup> three times each in six directions Malfunction: 98 m/s <sup>2</sup> three times each in six directions
<b>Ambient temperature</b>	Operating: -10°C to 55°C (with no icing) Storage: -25°C to 65°C (with no icing)
<b>Ambient humidity</b>	Operating: 35% to 85%
<b>Life expectancy</b>	Mechanical: 20 million operations min. (under no load at 1,800 operations/h) Electrical: 100,000 operations min. (5 A at 250 VAC, resistive load at 1,800 operations/h) (See note)
<b>EMC</b>	(EMI) EN61812-1 Emission Enclosure: EN55011 Group 1 class A Emission AC Mains: EN55011 Group 1 class A (EMS) EN61812-1 Immunity ESD: IEC61000-4-2 Immunity RF-interference: IEC61000-4-3 Immunity Burst: IEC61000-4-4 Immunity Surge: IEC61000-4-5 Immunity Conducted Disturbance: IEC61000-4-6 Immunity Voltage Dip/Interruption: IEC61000-4-11
<b>Case color</b>	Light Gray (Munsell 5Y7/1)
<b>Degree of protection</b>	IP40 (panel surface)
<b>Weight</b>	Approx. 100 g

Note: Refer to the *Life-test Curve (Reference)*.

## ■ Life-test Curve (Reference)

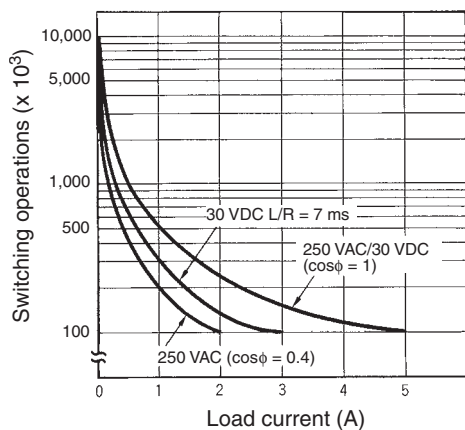

Reference: A maximum current of 0.15 A can be switched at 125 VDC (cosφ = 1) and a maximum current of 0.1A can be switched at 125V DC and L/R = 7ms. In both cases, a life of 100,000 operations can be expected. The minimum applicable load is 10 mA at 5 VDC (failure level: P).

# Connections

## ■ Block Diagrams

### H3CR-F/-F8/-FN/F8N

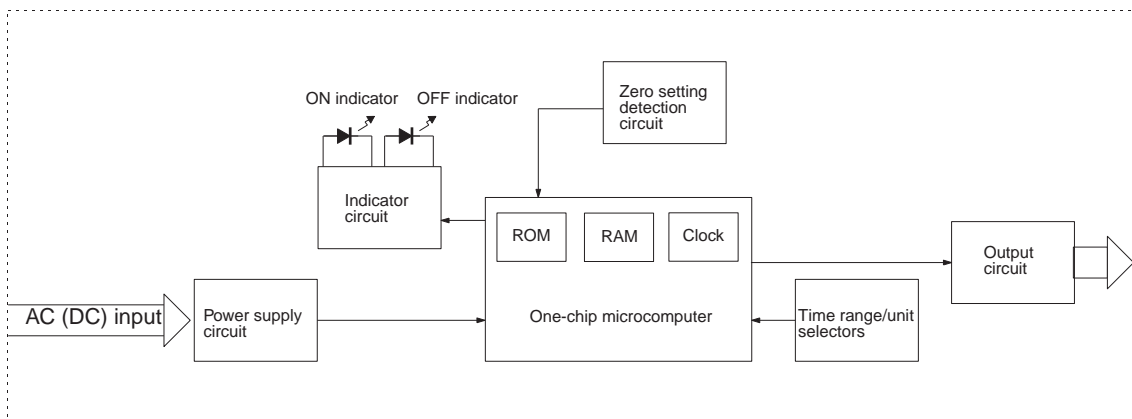

## ■ I/O Functions

Inputs	---	
Outputs	Control output	Outputs are turned ON/OFF according to the time set by the ON- and OFF-time setting knob.

## ■ Terminal Arrangement

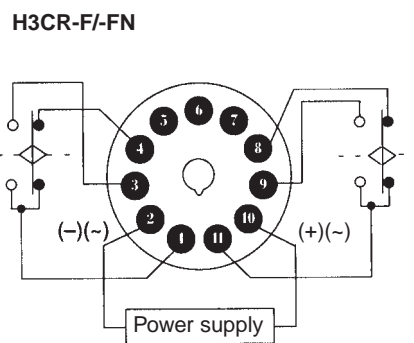
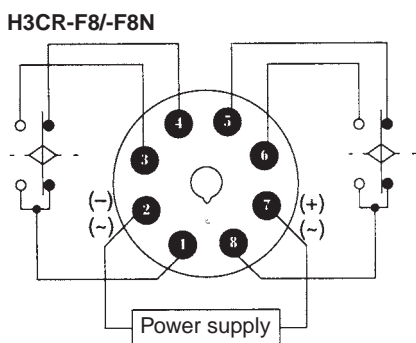

**Note:** Leave terminals 5, 6, and 7 open.  
Do not use them as relay terminals.

# Operation

## Timing Chart

$t_{ON}$ : ON set time  
 $t_{OFF}$ : OFF set time

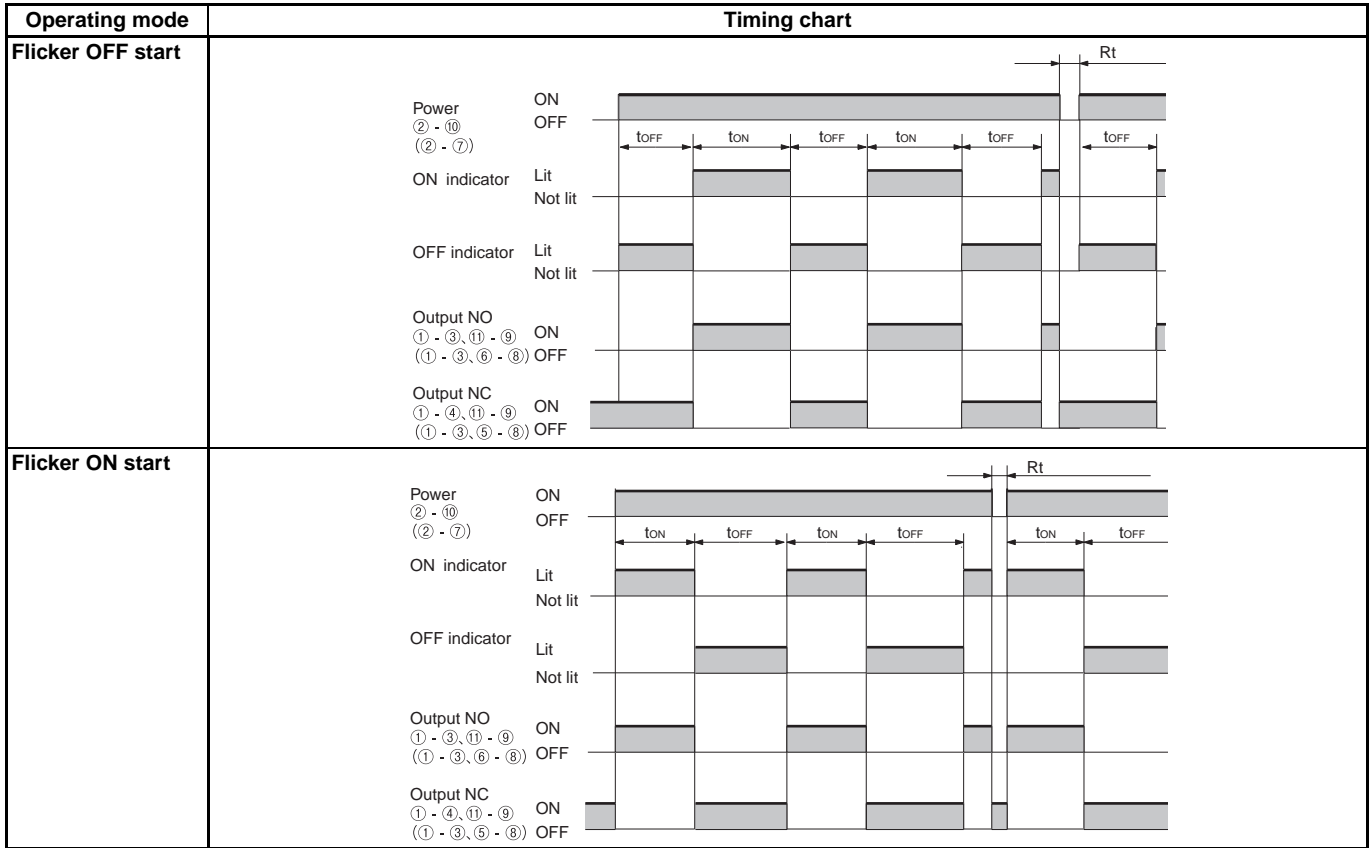

- Note:**
1. Allow a timer reset time ( $R_t$ ) of 0.1 s or longer
  2. When the setting dial is turned all the way past 0 for instantaneous output, "t" (set time) in the above time chart is 0-sec operation.

## Nomenclature

Scale range display windows changes as below by turning the Time range selector clockwise.

0	0.2	0.4	0.6	0.8	1.0	1.2
0	0.5	1	1.5	2	2.5	3
0	2	4	6	8	10	12
0	5	10	15	20	25	30

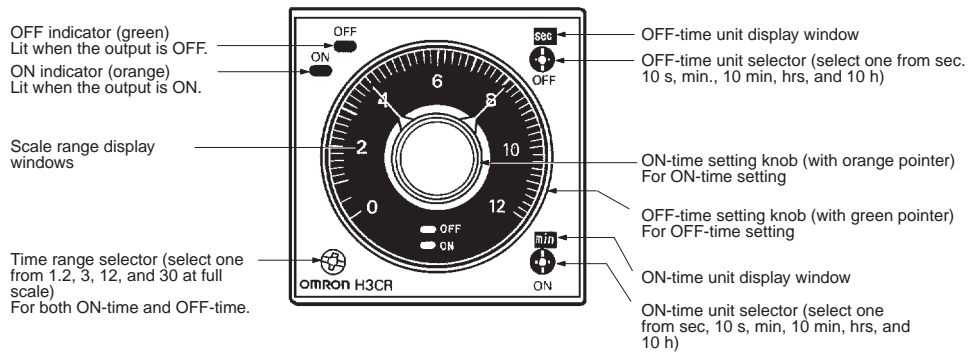

# Dimensions

**Note:** All units are in millimeters unless otherwise indicated.

H3CR-F  
H3CR-FN

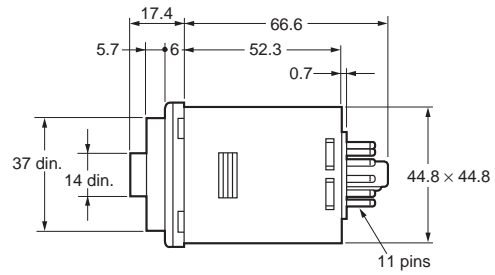
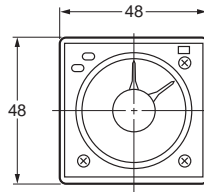
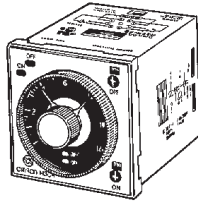

H3CR-F8  
H3CR-F8N

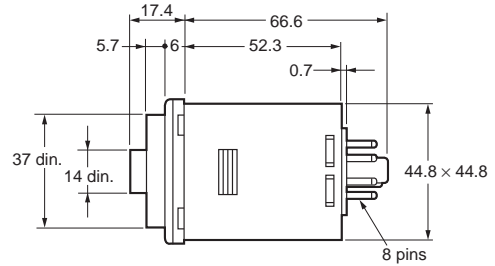
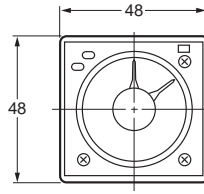
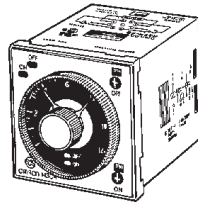

## Dimensions with Flush Mounting Adapter

Y92F-30 Flush Mounting Adapter (Order Separately)

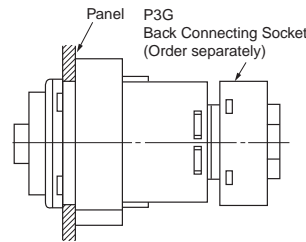
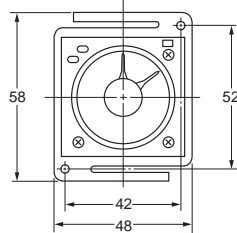
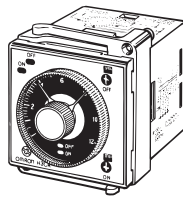
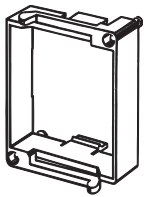

**Mounting Hole Dimensions (Conform to DIN 43700.)**

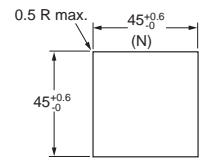

**Note: 1.** The orientation of the Adapters for two or more Timers is different for a horizontal or vertical layout. Make sure the orientation is correct.

Consecutive Mounting of n Timers

Without Front Covers:  $N = (48n - 2.5) + 1 - 0$

With Front Covers:  $N = (51n - 5.5) + 1 - 0$

With Panel Covers:  $N = (50n - 4.5) + 1 - 0$

**2.** The applicable thickness of the mounting panel must be 1 to 5 mm.

Y92F-73 Flush Mounting Adapter (Order Separately)

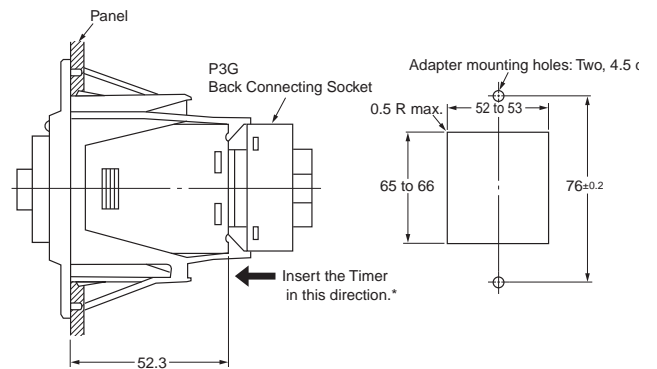
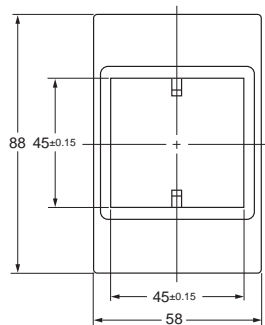
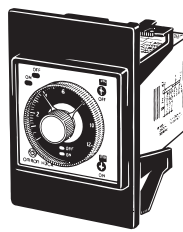
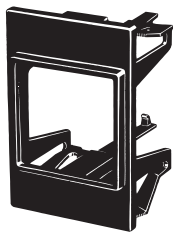

**Note:** A Front Cover and Flush Mounting Adapter cannot be used at the same time.

**Note:** The applicable thickness of the mounting panel must be 1 to 3.2 mm.

\* Insert the Timer from the back of the Adapter.



# H3CR-F

## Y92F-74 Flush Mounting Adapter (Order Separately)

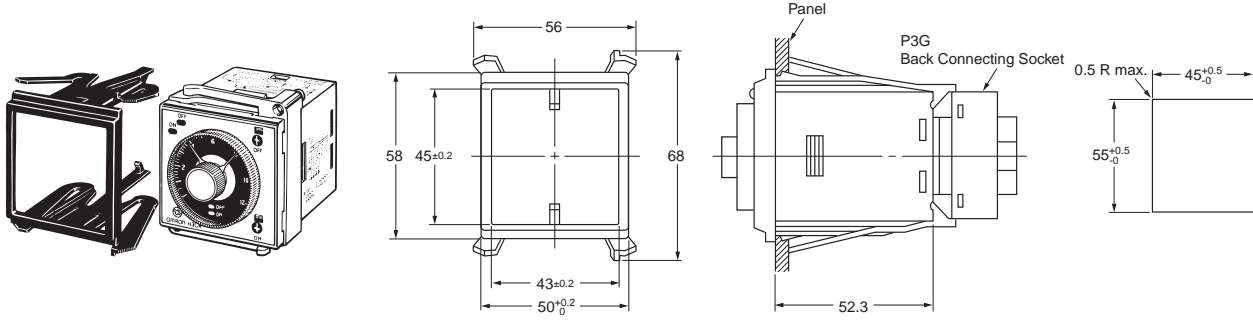

**Note:** A Front Cover and Flush Mounting Adapter cannot be used at the same time.

**Note:** The applicable thickness of the mounting panel must be 1 to 3.2 mm.

### Dimensions with Front Connecting Socket P2CF-08-□/ P2CF-11-□

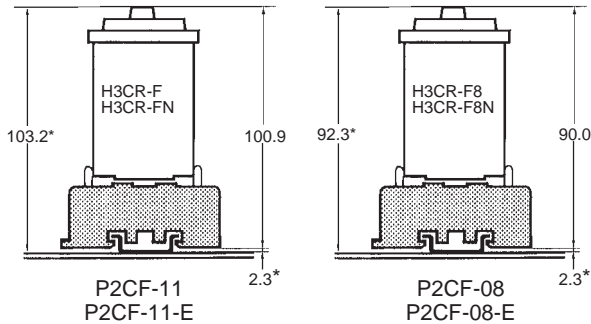

\* These dimensions vary with the kind of DIN track (reference value).

### Dimensions with Back Connecting Socket P3G-08/P3GA-11

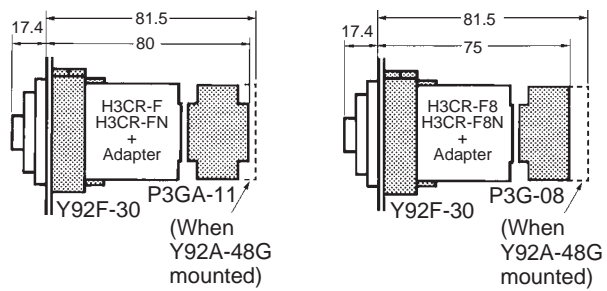

**Note:** There are no restrictions to the mounting direction.

## Accessories (Order Separately)

### Protective Cover Y92A-48B

To use the Protective Cover with a flush mounting, use the Y92F-30 flush mounting adaptor.

This Protective Cover cannot be used together with the Y92F-73/-74 flush mounting adaptor or the panel cover.

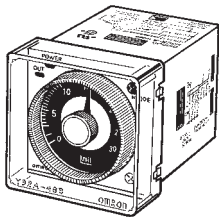

### Hold-down Clip Y92H-8

The Y92H-8 Hold-down Clip is attached to the PF085A socket.

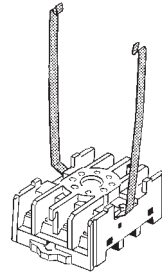

### Hold-down Clip Y92H-7

Y92H-7 Hold-down Clip is attached with screws together with the PL08 socket or the PL11 socket.

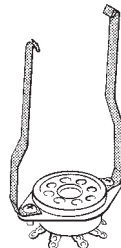

ALL DIMENSIONS SHOWN ARE IN MILLIMETERS.

To convert millimeters into inches, multiply by 0.03937. To convert grams into ounces, multiply by 0.03527.

In the interest of product improvement, specifications are subject to change without notice.

## DIN 48 × 48-mm Star-delta Timer



- A wide star-time range (up to 120 seconds) and star-delta transfer time range (up to 1 seconds).



For the most recent information on models that have been certified for safety standards, refer to your OMRON website.

## Model Number Structure

### Model Number Legend

H3CR - G 8 □ L □  
 1 2 3 4 5

#### 1. Classification

G: Star-delta timer

#### 2. Configuration

8: 8-pin socket

#### 3. Outputs

None: Star-delta operation contact

E: Star-delta operation contact and instantaneous contact

#### 4. Dimensions

L: Long-body model

#### 5. Supply Voltage

100-120AC: 100 to 120 VAC

200-240AC: 200 to 240 VAC

## Ordering Information

### List of Models

Outputs	Supply voltage	8-pin models
Time-limit contact	100 to 120 VAC	H3CR-G8L 100-120AC
	200 to 240 VAC	H3CR-G8L 200-240AC
Time-limit contact and instantaneous contact	100 to 120 VAC	H3CR-G8EL 100-120AC
	200 to 240 VAC	H3CR-G8EL 200-240AC

**Note:** Specify both the model number and supply voltage when ordering.

Example: H3CR-G8L 100-120AC

Supply voltage

## Accessories (Order Separately)

### ■ Accessories (Order Separately)

#### Adapter, Protective Cover, Setting Ring and Panel Cover

Name/specifications		Models
Flush Mounting Adapter		Y92F-30 Y92F-70 *1 Y92F-71 *1
Protective Cover		Y92A-48B *2
Hold-down Clip	For PF085A Socket	Y92H-2
	For PL08 Sockets	Y92H-1
Setting Ring A		Y92S-27 *3
Setting Ring B and C		Y92S-28 *3
Panel Cover	Light gray (5Y7/1)	Y92P-48GL *4
	Black (N1.5)	Y92P-48GB *4

**Note:** Refer to Operation (Common) datasheet for detail.

\*1 The Y92A-48B Protective Cover and the Y92P-48G□ Panel Cover can not be used at the same time with the Y92F-70/-71 Flush Mounting Adapter.

\*2 The Y92A-48B Protective Cover is made from hard plastic. Remove the Protective Cover to change to set value. The Y92F-70/-71 Flush Mounting Adapter and the Y92P-48G□ Panel Cover cannot be used at the same time with Y92A-48B Protective Cover.

\*3 The Y92S-27/-28 Setting Ring cannot be used alone. It must be used together with the Y92P-48G□ Panel Cover.

\*4 The Y92A-48B Protective Cover and the Y92F-70/-71 Flush Mounting Adapter cannot be used at the same time with the Y92P-48G□ Panel Cover.

### Sockets

Timer Pin	Round Sockets		
	Connection	Terminal	Models
8-pin	Front Connecting	DIN track mounting	P2CF-08
		DIN track mounting (Finger-safe type)	P2CF-08-E
		DIN track mounting	PF085A
	Back Connecting	Screw terminal	P3G-08
		Solder terminal	PL08
		Wrapping terminal	PL08-Q
		PCB terminal	PLE08-0

**Note:** 1. The P2CF-08-E has a finger-protection structure. Round crimp terminals cannot be used. Use forked crimp terminals.

2. The P3G-08 Socket can be used together with the Y92A-48G Terminal Cover to implement finger protection.

3. For details, refer to your OMRON website.

### Terminal Cover

Application	Model	Remarks
For back connecting socket	Y92A-48G	For P3G-08 and P3GA-11

**Note:** For details, refer to your OMRON website.

# Specifications

## ■ General

Item	H3CR-G8L	H3CR-G8EL
Functions	Star-delta timer	Star-delta timer with instantaneous output
Pin type	8-pin	
Operating/Reset method	Time-limit operation/Self-reset	
Output type	Time-limit: SPST-NO (star operation circuit) SPST-NO (delta operation circuit)	Time-limit: SPST-NO (star operation circuit) SPST-NO (delta operation circuit) Instantaneous: SPST-NO
Mounting method	DIN track mounting, surface mounting, and flush mounting	
Approved standards	UL508, CSA C22.2 No.14, NK, Lloyds, CCC Conforms to EN61812-1 and IEC60664-1 (VDE0110) 4kV/2. Output category according to EN60947-5-1.	

Note: For details, refer to your OMRON website.

## ■ Time Ranges

Time unit		Star operation time ranges
Scale number (max.)		
6	Set time range	0.5 to 6 s
12		1 to 12 s
60		5 to 60 s
120		10 to 120 s

Star-delta transfer time	Programmable at 0.05 s, 0.1 s, 0.25 s, 0.5 s, 0.75 s, or 1.0 s
--------------------------	--

## ■ Ratings

Rated supply voltage (See notes 1 and 2.)	100 to 120 VAC (50/60 Hz), 200 to 240 VAC (50/60 Hz)
Operating voltage range	85% to 110% of rated supply voltage
Power reset	Minimum power-opening time: 0.5 s
Power consumption	100 to 120 VAC: approx. 6 VA (2.6 W) at 120 VAC 200 to 240 VAC: approx. 12 VA (3.0 W) at 240 VAC
Control outputs	Contact output: 5 A at 250 VAC/30 VDC, resistive load ( $\cos\phi = 1$ ) The minimum applicable load is 10mA at 5VDC (P reference value). Contact materials : Ag-alloy

Note: 1. Do not use an inverter output as the power supply. Refer to your OMRON website for details.

2. Refer to your OMRON website when using the Timer together with a 2-wire AC proximity sensor.

# H3CR-G

## ■ Characteristics

<b>Accuracy of operating time</b>	±0.2% FS max.
<b>Setting error</b>	±5% FS ±50 ms max.
<b>Accuracy of Star-delta transfer time</b>	±25% FS + 5 ms max.
<b>Reset voltage</b>	10% max. of rated voltage
<b>Influence of voltage</b>	±0.2% FS max.
<b>Influence of temperature</b>	±1% FS max.
<b>Insulation resistance</b>	100 MΩ min. (at 500 VDC)
<b>Dielectric strength</b>	2,000 VAC, 50/60 Hz for 1 min (between current-carrying metal parts and exposed non-current-carrying metal parts) 2,000 VAC, 50/60 Hz for 1 min (between control output terminals and operating circuit) 2,000 VAC, 50/60 Hz for 1 min (between contacts of different polarities) 1,000 VAC, 50/60 Hz for 1 min (between contacts not located next to each other)
<b>Impulse withstand voltage</b>	5 kV (between power terminals) 5 kV (between current-carrying terminal and exposed non-current-carrying metal parts)
<b>Noise immunity</b>	±1.5 kV (between power terminals), square-wave noise by noise simulator (pulse width: 100 ns/1 μs, 1-ns rise)
<b>Static immunity</b>	Malfunction: 8 kV Destruction: 15 kV
<b>Vibration resistance</b>	Destruction: 10 to 55 Hz with 0.75-mm single amplitude for 2 hrs each in three directions Malfunction: 10 to 55 Hz with 0.5-mm single amplitude for 10 min each in three directions
<b>Shock resistance</b>	Destruction: 980 m/s <sup>2</sup> three times each in six directions Malfunction: 294 m/s <sup>2</sup> three times each in six directions
<b>Ambient temperature</b>	Operating: -10°C to 55°C (with no icing) Storage: -25°C to 65°C (with no icing)
<b>Ambient humidity</b>	Operating: 35% to 85%
<b>Life expectancy</b>	Mechanical: 20 million operations min. (under no load at 1,800 operations/h) Electrical: 100,000 operations min. (5 A at 250 VAC, resistive load at 1,800 operations/h) (See note)
<b>EMC</b>	(EMI) EN61812-1 Emission Enclosure: EN55011 Group 1 class A Emission AC Mains: EN55011 Group 1 class A (EMS) EN61812-1 Immunity ESD: IEC61000-4-2 Immunity RF-interference: IEC61000-4-3 Immunity Burst: IEC61000-4-4 Immunity Surge: IEC61000-4-5 Immunity Conducted Disturbance: IEC61000-4-6 Immunity Voltage Dip/Interruption: IEC61000-4-11
<b>Case color</b>	Light Gray (Munsell 5Y7/1)
<b>Degree of protection</b>	IP40 (panel surface)
<b>Weight</b>	H3CR-G8L: approx. 110 g; H3CR-G8EL: approx. 130 g

**Note:** Refer to the *Life-test Curve (Reference)*.

## Life-test Curve (Reference)

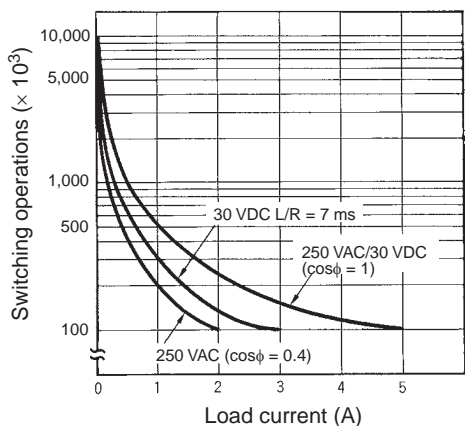

Reference: A maximum current of 0.15 A can be switched at 125 VDC ( $\cos\phi = 1$ ) and a maximum current of 0.1A can be switched at 125V DC and L/R = 7ms. In both cases, a life of 100,000 operations can be expected. The minimum applicable load is 10 mA at 5 VDC (failure level: P).

## Connections

### Block Diagrams

H3CR-G8L

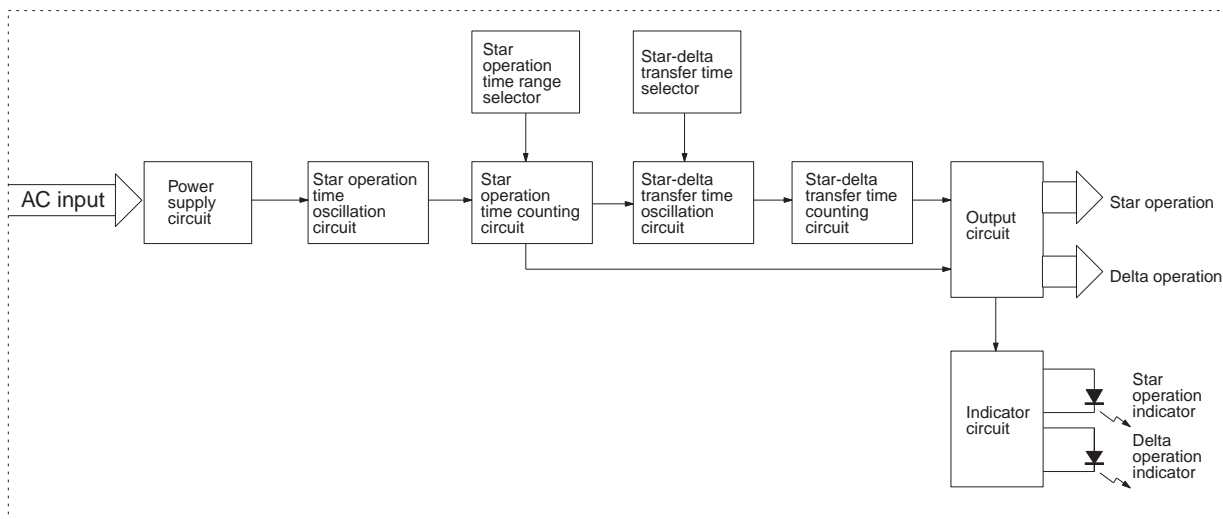

H3CR-G8EL

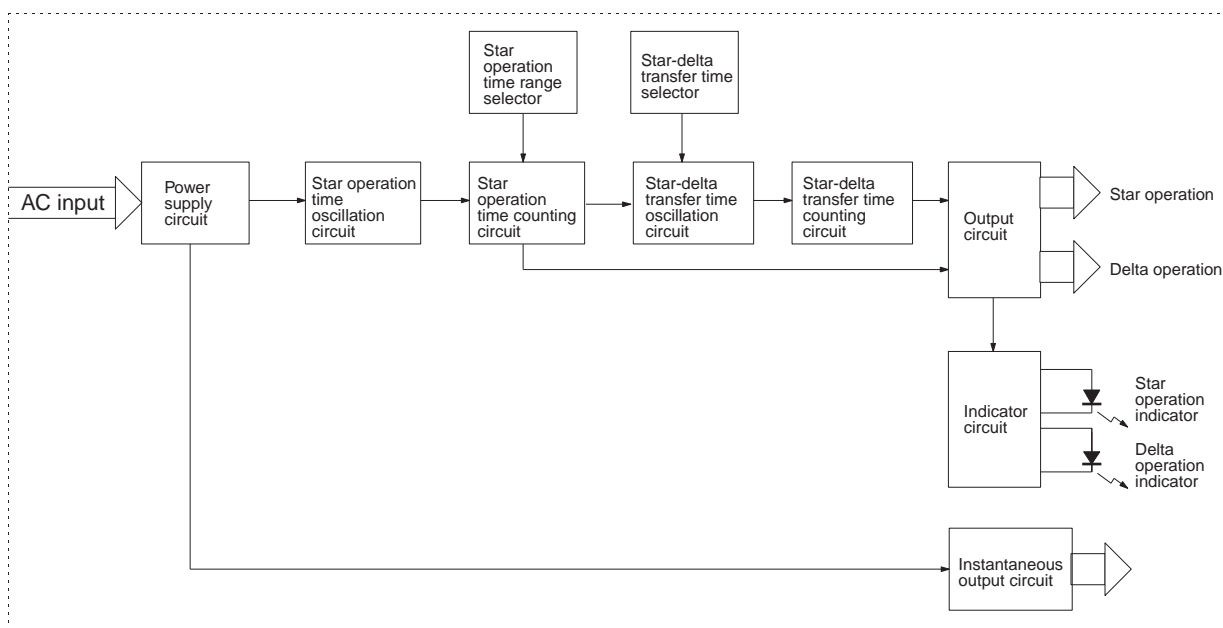

# H3CR-G

## I/O Functions

Inputs	---	
Outputs	Control output	If the time reaches the value set with the time setting knob, the star operation output will be turned OFF and there will be delta operation output after the set star-delta transfer time has elapsed.

## Terminal Arrangement

H3CR-G8L

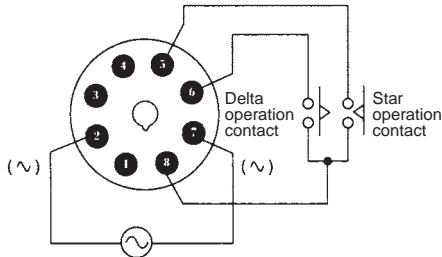

**Note:** Leave terminals 1, 3, and 4 open. Do not use them as relay terminals.

H3CR-G8EL

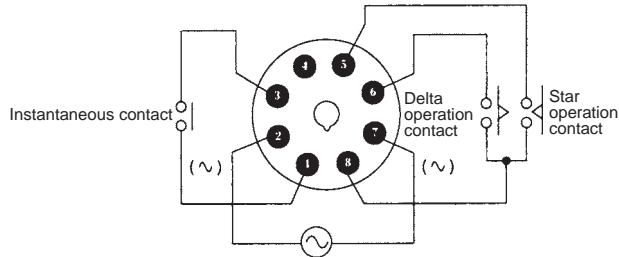

**Note:** Leave terminal 4 open. Do not use them as relay terminals.

## Operation

### Timing Chart

- t1: Star operation time setting
- t2: Star-delta transfer time

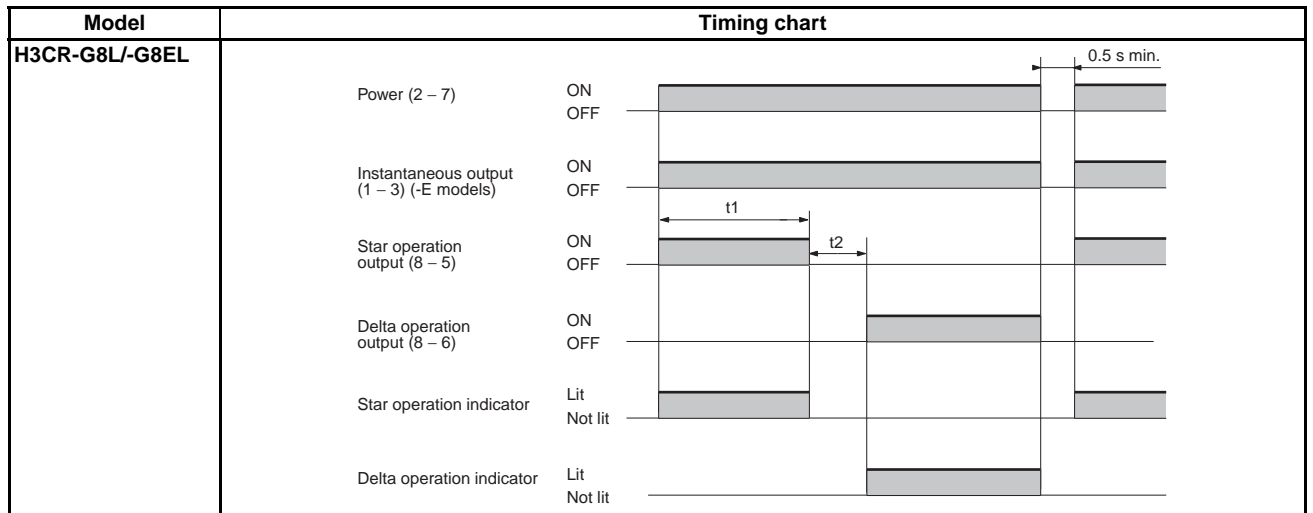

## Nomenclature

Scale range display windows changes as below by turning the Time range selector clockwise.

0	1	2	3	4	5	6
0	2	4	6	8	10	12
0	10	20	30	40	50	60
0	20	40	60	80	100	120

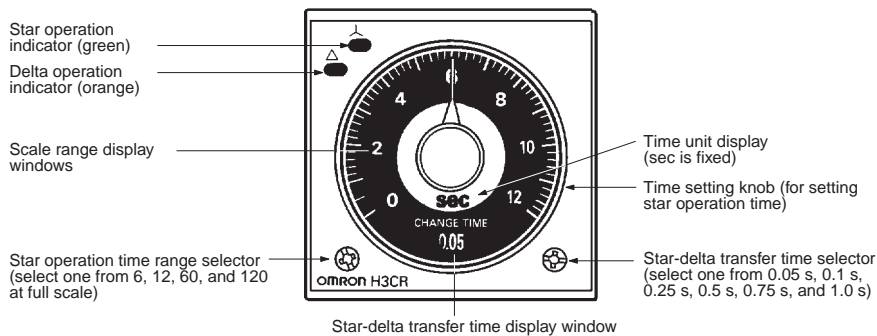

# Dimensions

**Note:** All units are in millimeters unless otherwise indicated.

## Dimension of Timer main unit

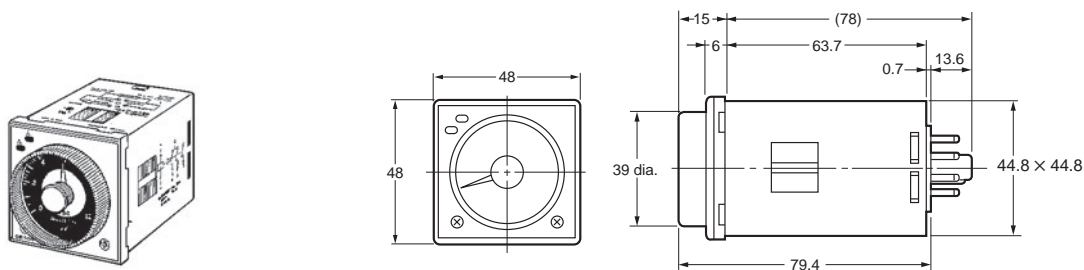

## Dimensions with Set Ring and Panel Cover Y92S-27/-28 (Order Separately)

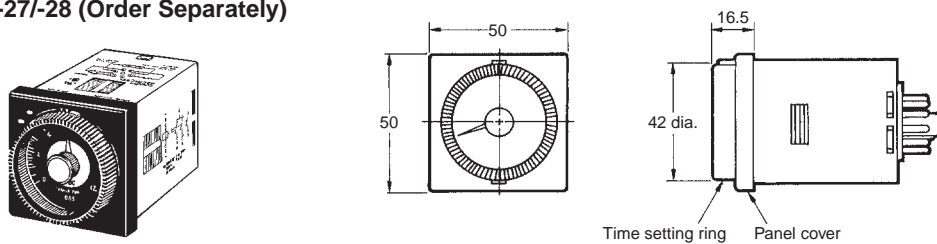

## Dimensions with Front Connecting Socket P2CF-08-□

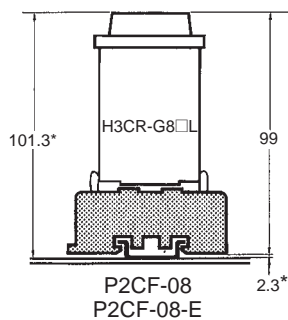

## Dimensions with Back Connecting Socket P3G-08

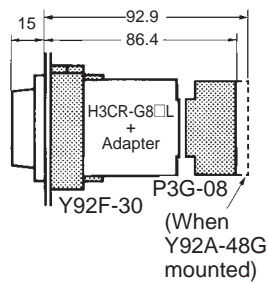

**Note:** There are no restrictions to the mounting direction.  
\* These dimensions vary with the kind of DIN track (reference value).



## H3CR-G

### ■ Accessories (Order Separately)

#### Protective Cover

##### Y92A-48B

To use the Protective cover with a flush mounting, use the Y92F-30 flush mounting adaptor.

This Protective cover cannot be used together with the Y92F-70/-71 flush mounting adaptor or the panel cover.

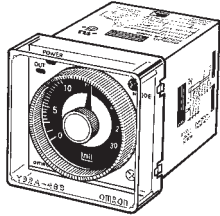

#### Hold-down Clip

##### Y92H-2

The Y92H-2 Hold-down Clip is attached to the PF085A socket.

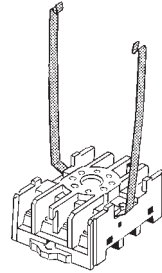

##### Y92H-1

Y92H-1 Hold-down Clip is attached with screws together with the PL08 socket.

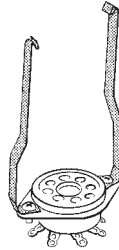

ALL DIMENSIONS SHOWN ARE IN MILLIMETERS.

To convert millimeters into inches, multiply by 0.03937. To convert grams into ounces, multiply by 0.03527.

In the interest of product improvement, specifications are subject to change without notice.

# H3CR-H

## DIN 48 × 48-mm Power OFF-delay Timer



- Long power OFF-delay times;  
S-series: up to 12 seconds,  
M-series: up to 12 minutes.
- Models with forced-reset input are available.
- 11-pin and 8-pin models are available.



For the most recent information on models that have been certified for safety standards, refer to your OMRON website.

## Model Number Structure

### Model Number Legend

**Note:** This model number legend includes combinations that are not available. Before ordering, please check the *List of Models* on page 42 for availability.

H3CR - H □ □ L □ □  
1 2 3 4 5 6

**Note:** Specify the model number, supply voltage, and time range (S or M) when ordering.

#### 1. Classification

H: Power OFF-delay timer

#### 2. Configuration

None: 11-pin socket

8: 8-pin socket

#### 3. Input

None: Without reset input

R: With reset input

#### 4. Dimensions

L: Long-body model

#### 5. Supply Voltage

100-120AC: 100 to 120 VAC

200-240AC: 200 to 240 VAC

24AC/DC: 24VAC/DC

48DC: 48 VDC

100-125DC: 100 to 125 VDC

#### 6. Time Range

S: 0.05 to 12 s

M: 0.05 to 12 min

### List of Models

Input	Output	Supply voltage	S-series		M-series	
			11-pin models	8-pin models	11-pin models	8-pin models
Without reset input	DPDT	100 to 120 VAC	---	H3CR-H8L 100-120AC S	---	H3CR-H8L 100-120AC M
		200 to 240 VAC	---	H3CR-H8L 200-240AC S	---	H3CR-H8L 200-240AC M
		24 VAC/DC	---	H3CR-H8L 24AC/DC S	---	H3CR-H8L 24AC/DC M
		48 VDC	---	H3CR-H8L 48DC S	---	H3CR-H8L 48DC M
		100 to 125 VDC	---	H3CR-H8L 100-125DC S	---	H3CR-H8L 100-125DC M
With reset input	None	100 to 120 VAC	H3CR-HRL 100-120AC S	---	H3CR-HRL 100-120AC M	---
		200 to 240 VAC	H3CR-HRL 200-240AC S	---	H3CR-HRL 200-240AC M	---
		24 VAC/DC	H3CR-HRL 24AC/DC S	---	H3CR-HRL 24AC/DC M	---
		48 VDC	H3CR-HRL 48DC S	---	H3CR-HRL 48DC M	---
		100 to 125 VDC	H3CR-HRL 100-125DC S	---	H3CR-HRL 100-125DC M	---
	SPDT	100 to 120 VAC	---	H3CR-H8RL 100-120AC S	---	H3CR-H8RL 100-120AC M
		200 to 240 VAC	---	H3CR-H8RL 200-240AC S	---	H3CR-H8RL 200-240AC M
		24 VAC/DC	---	H3CR-H8RL 24AC/DC S	---	H3CR-H8RL 24AC/DC M
		48 VDC	---	H3CR-H8RL 48DC S	---	H3CR-H8RL 48DC M
		100 to 125 VDC	---	H3CR-H8RL 100-125DC S	---	H3CR-H8RL 100-125DC M

**Note:** Specify the model number, supply voltage, and time range (S or M) when ordering.

Example: H3CR-H8L 100-120AC S

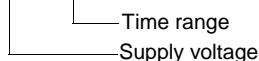

# H3CR-H

## ■ Accessories (Order Separately)

### Adapter, Protective Cover and Hold-down Clip

Name/specifications		Models
Flush Mounting Adapters		Y92F-30
		Y92F-70 *1
		Y92F-71 *1
Protective Cover		Y92A-48B *2
Hold-down Clips	For PF085A Socket	Y92H-2
	For PL08 or PL11 Sockets	Y92H-1

**Note:** Refer to Operation (Common) datasheet for details.  
 \*1. The Y92A-48B Protective Cover and the Y92F-70/-71 Flush Mounting Adapter cannot be used at the same time.  
 \*2. The Y92F-48B Protective Cover is made from hard plastic. Remove the Protective Cover to change the set value.

## ■ Sockets

Timer Pin	Round Sockets		
	Connection	Terminal	Models
11-pin	Front Connecting	DIN track mounting	P2CF-11
		DIN track mounting (Finger-safe type)	P2CF-11-E
	Back Connecting	Screw terminal	P3GA-11
		Solder terminal	PL11
		Wrapping terminal	PL11-Q
		PCB terminal	PLE11-0
8-pin	Front Connecting	DIN track mounting	P2CF-08
		DIN track mounting (Finger-safe type)	P2CF-08-E
		DIN track mounting	PF085A
	Back Connecting	Screw terminal	P3G-08
		Solder terminal	PL08
		Wrapping terminal	PL08-Q
		PCB terminal	PLE08-0

**Note:** 1. The P2CF-□□-E has a finger-protection structure. Round crimp terminals cannot be used. Use forked crimp terminals.  
 2. The P3GA-11 and P3G-08 Socket can be used together with the Y92A-48G Terminal Cover to implement finger protection.  
 3. For details, refer to your OMRON website.

## ■ Terminal Cover

Application	Model	Remarks
For back connecting socket	Y92A-48G	For P3G-08 and P3GA-11

**Note:** For details, refer to your OMRON website.

# Specifications

## ■ General

Item	H3CR-H8L	H3CR-H8RL	H3CR-HRL
Operating/Reset method	Instantaneous operation/Time-limit reset	Instantaneous operation/Time-limit reset/Forced reset	
Pin type	8-pin		11-pin
Input type	---	No-voltage input	
Output type	Relay output (DPDT)	Relay output (SPDT)	Relay output (DPDT)
Mounting method	DIN track mounting, surface mounting, and flush mounting		
Approved standards	UL508, CSA C22.2 No.14, NK, Lloyds, CCC Conforms to EN61812-1 and IEC60664-1 (VDE0110) 4kV/2. Output category according to EN60947-5-1.		

**Note:** For details, refer to your OMRON website.

## ■ Time Ranges

Scale number (max.)	Time unit	S-series	M-series
		s (sec)	min (min)
0.6	Set time range	0.05 to 0.6	
1.2		0.12 to 1.2	
6		0.6 to 6	
12		1.2 to 12	
Min. power ON time		0.1 s min.	2 s min.
Time-up operation repeat period		3 s min.	
Forced-reset repeat period		3 s min.	

**Note:** 1. If the above minimum power ON time is not secured, the H3CR may not operate. Be sure to secure the above minimum power ON time.  
 2. Do not use the Timer with a repeat period of less than 3 s. Doing so may result in abnormal heating or burning. Refer to *Safety Precautions (H3CR-H)* on page 50 for details.

## ■ Ratings

<b>Rated supply voltage (See notes 1 and 2.)</b>	100 to 120 VAC (50/60 Hz), 200 to 240 VAC (50/60 Hz), 24 VAC/VDC (50/60 Hz), 48 VDC, 100 to 125 VDC
<b>Operating voltage range</b>	85% to 110% of rated supply voltage
<b>No-voltage input (See note 3.)</b>	ON-impedance: 1 kΩ max. ON residual voltage: 1 V max. OFF impedance: 500 kΩ min.
<b>Power consumption</b>	100 to 120 VAC: approx. 0.23 VA (0.22 W) at 120 VAC 200 to 240 VAC: approx. 0.35 VA (0.3 W) at 240 VAC 24 VAC/DC: approx. 0.17 VA (0.15 W) at 24 VAC approx. 1.0 W at 24 VDC 48 VDC: approx. 0.18 W at 48 VDC 100 to 125 VDC: approx. 0.5 W at 125 VDC
<b>Control outputs</b>	Contact output: 5 A at 250 VAC/30 VDC, resistive load ( $\cos\phi = 1$ ) The minimum applicable load is 10mA at 5VDC (P reference value). Contact materials : Ag-alloy

**Note: 1.** A power supply with a ripple of 20% max. (single-phase power supply with full-wave rectification) can be used with each DC Model.

**2.** Do not use an inverter output as the power supply. Refer to your OMRON website for details.

**3.** For contact input, use contacts which can adequately switch 1 mA at 5 V.

## ■ Characteristics

<b>Accuracy of operating time</b>	±0.2% FS max. (±0.2% FS ±10 ms max. in ranges of 0.6 and 1.2 s)
<b>Setting error</b>	±5% FS ±50 ms max.
<b>Operation start voltage</b>	30% max. of rated voltage
<b>Influence of voltage</b>	±0.2% FS max. (±0.2% FS ±10 ms max. in ranges of 0.6 and 1.2 s)
<b>Influence of temperature</b>	±1% FS max. (±1% FS ±10 ms max. in ranges of 0.6 and 1.2 s)
<b>Insulation resistance</b>	100 MΩ min. (at 500 VDC)
<b>Dielectric strength</b>	2,000 VAC, 50/60 Hz for 1 min (between current-carrying metal parts and exposed non-current-carrying metal parts) 2,000 VAC, 50/60 Hz for 1 min (between control output terminals and operating circuit) 2,000 VAC, 50/60 Hz for 1 min (between contacts of different polarities) 1,000 VAC, 50/60 Hz for 1 min (between contacts not located next to each other)
<b>Impulse withstand voltage</b>	5 kV (between power terminals) for 100 to 120 VAC, 200 to 240 VAC, 100 to 125 VDC; 1 kV for 24 VAC/DC, 48 VDC 5 kV (between current-carrying terminal and exposed non-current-carrying metal parts) for 100 to 120 VAC, 200 to 240 VAC, 100 to 125 VDC; 1.5 kV for 24 VAC/DC, 48 VDC
<b>Noise immunity</b>	±1.5 kV (between power terminals) and ±600 V (between input terminals), square-wave noise by noise simulator (pulse width: 100 ns/1 μs, 1-ns rise); ±1 kV (between power terminals) for 48 VDC
<b>Static immunity</b>	Malfunction: 8 kV, Destruction: 15 kV
<b>Vibration resistance</b>	Destruction: 10 to 55 Hz with 0.75-mm single amplitude for 2 hrs each in three directions Malfunction: 10 to 55 Hz with 0.5-mm single amplitude for 10 min each in three directions
<b>Shock resistance</b>	Destruction: 980 m/s <sup>2</sup> three times each in six directions Malfunction: 98 m/s <sup>2</sup> three times each in six directions
<b>Ambient temperature</b>	Operating: -10°C to 55°C (with no icing), Storage: -25°C to 65°C (with no icing)
<b>Ambient humidity</b>	Operating: 35% to 85%
<b>Life expectancy</b>	Mechanical: 10 million operations min. (under no load at 1,200 operations/h) Electrical: 100,000 operations min. (5 A at 250 VAC, resistive load at 1,200 operations/h) (See note)
<b>EMC</b>	(EMI) EN61812-1 Emission Enclosure: EN55011 Group 1 class A Emission AC Mains: EN55011 Group 1 class A (EMS) EN61812-1 Immunity ESD: IEC61000-4-2 Immunity RF-interferenc: IEC61000-4-3 Immunity Burst: IEC61000-4-4 Immunity Surge: IEC61000-4-5 Immunity Conducted Disturbance: IEC61000-4-6 Immunity Voltage Dip/Interruption: IEC61000-4-11
<b>Case color</b>	Light Gray (Munsell 5Y7/1)
<b>Degree of protection</b>	IP40 (panel surface)
<b>Weight</b>	Approx. 120 g

**Note:** Refer to the *Life-test Curve(Reference)*.

# H3CR-H

## Life-test Curve(Reference)

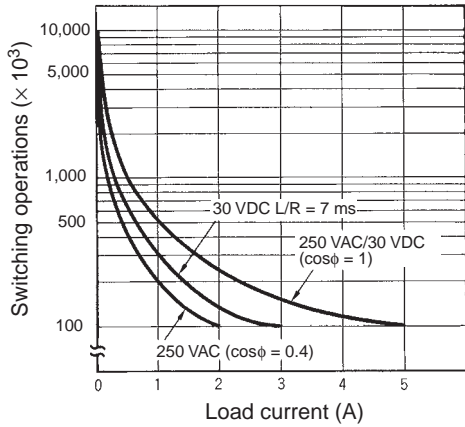

Reference: A maximum current of 0.15 A can be switched at 125 VDC (cos φ = 1) and a maximum current of 0.1A can be switched at 125V DC and L/R = 7ms. In both cases, a life of 100,000 operations can be expected.

The minimum applicable load is 10 mA at 5 VDC for H3CR-H8L/-HRL and 100 mA at 5 VDC for H3CR-H8RL (failure level: P).

## Connections

### Block Diagrams

Without Reset Input (H3CR-H8L)

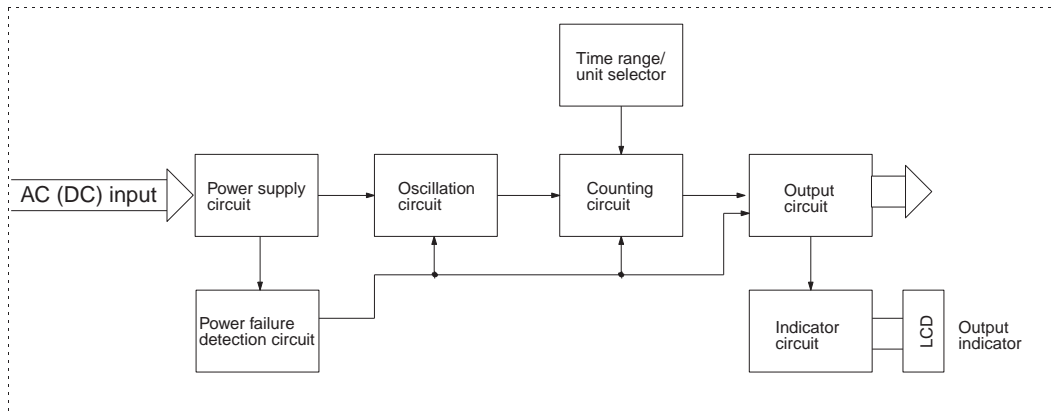

With Reset Input (H3CR-H8RL/-HRL)

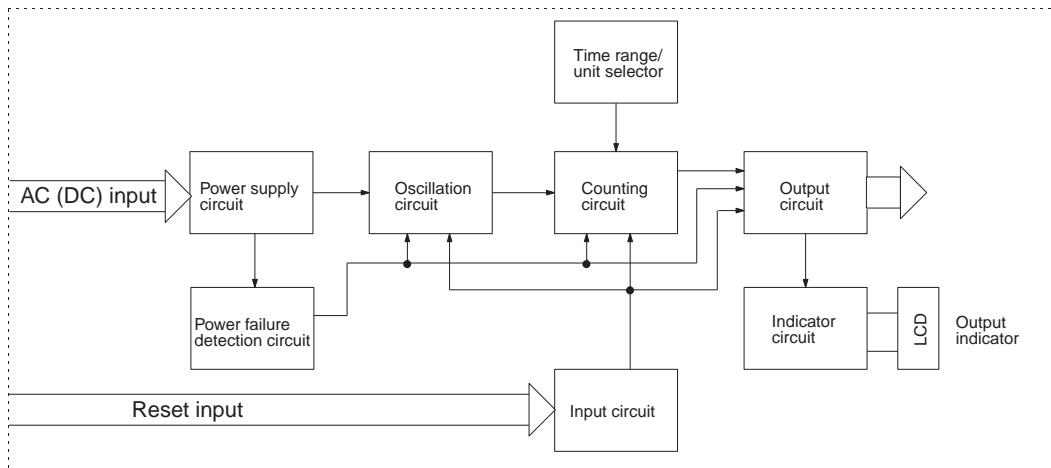

### I/O Functions

<b>Inputs</b>	<b>Reset</b>	Turns off the control output and resets the elapsed time.
<b>Outputs</b>	<b>Control output</b>	Operates instantaneously when the power is turned on and time-limit resets when the set time is up after the power is turned off.

## Terminal Arrangement

**Note:** DC models, including 24 VAC/DC models, have polarity.

### 8-pin Models

#### Without Reset Input (H3CR-H8L)

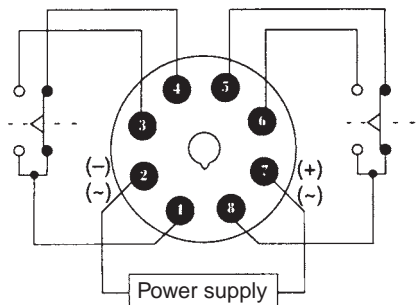

#### With Reset Input (H3CR-H8RL)

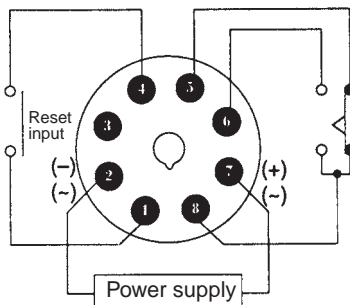

**Note:** Leave terminal 3 open. Do not use them as relay terminals.

### 11-pin Model

#### With Reset Input (H3CR-HRL)

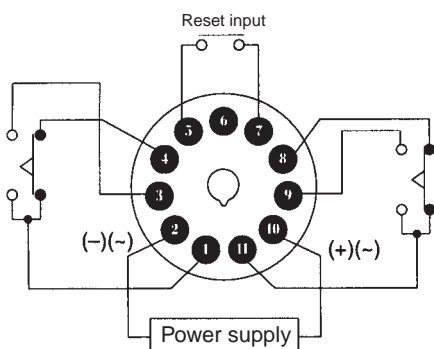

**Note:** Leave terminal 6 open. Do not use them as relay terminals.

## ■ Timing Chart

t: Set time

Rt: Minimum power ON time (S-series: 0.1 s min.; M-series: 2 s min.)

If the power ON time is less than this value, the Timer may not operate (i.e., output may not turn ON).

Model	Timing chart
H3CR-H8L	<p>The timing chart for H3CR-H8L shows two power ON cycles. In each cycle, the power is turned ON for a duration <math>R_t</math> (minimum power ON time) and then OFF for a duration <math>t</math> (set time). The outputs (1-3), (1-4), (8-6), and (8-5) are active during the power ON period. The output indicator is lit during the power ON period and not lit during the power OFF period.</p>
H3CR-H8RL	<p>The timing chart for H3CR-H8RL shows two power ON cycles. The power is turned ON for a duration <math>R_t</math> and then OFF for a duration <math>t</math>. The reset input is turned ON (short-circuited) for a duration of 0.05 s min. during the power OFF period. The outputs (8-6) and (8-5) are active during the power ON period. The output indicator is lit during the power ON period and not lit during the power OFF period.</p>
H3CR-HRL	<p>The timing chart for H3CR-HRL shows two power ON cycles. The power is turned ON for a duration <math>R_t</math> and then OFF for a duration <math>t</math>. The reset input is turned ON for a duration of 0.05 s min. during the power OFF period. The outputs (1-3), (1-4), (11-9), and (11-8) are active during the power ON period. The output indicator is lit during the power ON period and not lit during the power OFF period.</p>

**Note:** If the power is turned ON until the set time is up, the timer will be retrigged.

# Nomenclature

Scale range display windows changes as below by turning the Time range selector clockwise.

0	0.1	0.2	0.3	0.4	0.5	0.6
0	0.2	0.4	0.6	0.8	1.0	1.2
0	1	2	3	4	5	6
0	2	4	6	8	10	12

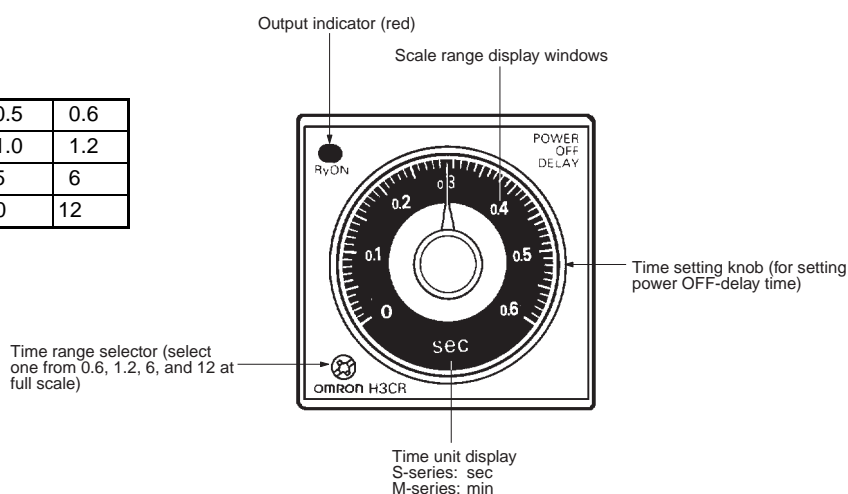

# Dimensions

Note: All units are in millimeters unless otherwise indicated.

## H3CR-H8L H3CR-H8RL

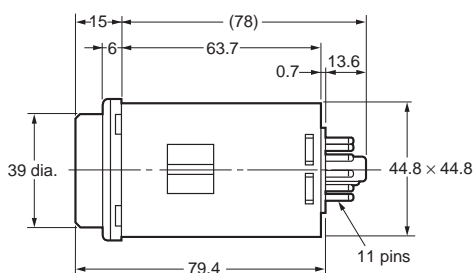
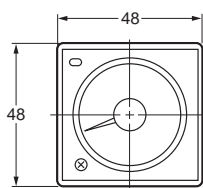
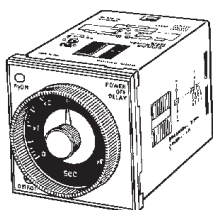

## H3CR-HRL

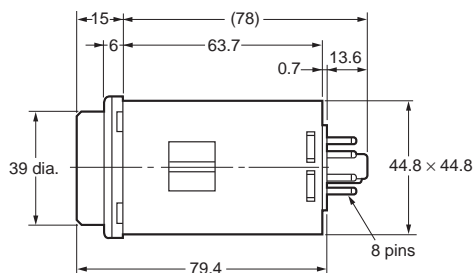
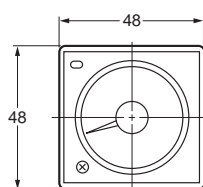
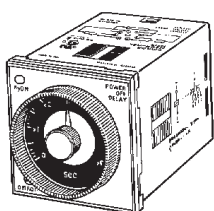

### Dimensions with Front Connecting Socket P2CF-08-□/ P2CF-11-□

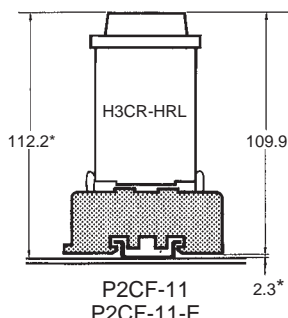
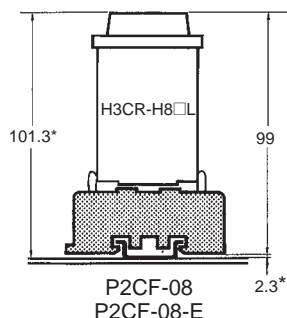

### Dimensions with Back Connecting Socket P3G-08/P3GA-11

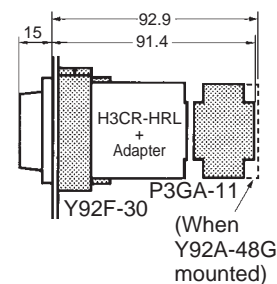
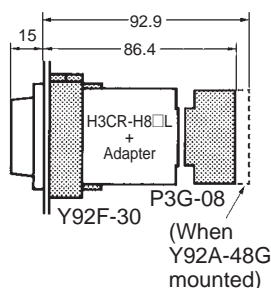

Note: There are no restrictions to the mounting direction.  
\* These dimensions vary with the kind of DIN track (reference value).



## H3CR-H

### ■ Accessories (Order Separately)

#### Protective Cover

##### Y92A-48B

To use the Protective Cover with a flush mounting, use the Y92F-30 flush mounting adaptor.

This Protective Cover cannot be used together with the Y92F-70/-71 flush mounting adaptor or the panel cover.

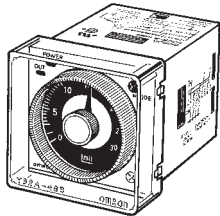

#### Hold-down Clip

##### Y92H-2

The Y92H-2 Hold-down Clip is attached to the PF085A socket.

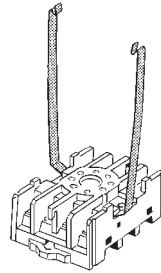

##### Y92H-1

Y92H-1 Hold-down Clip is attached with screws together with the PL08.

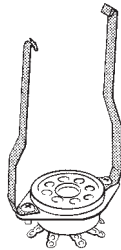

## Safety Precautions (H3CR-H)

**Note:** The undermentioned is common for all H3CR-H models.

### Power Supplies

The H3CR-H has a large inrush current; provide sufficient power supply capacity. If the power supply capacity is too small, there may be delays in turning ON the output.

With the H3CR-H□RL, for the power supply of an input device, use an isolating transformer, of which the primary and secondary windings are mutually isolated and the secondary winding is not grounded.

#### Correct

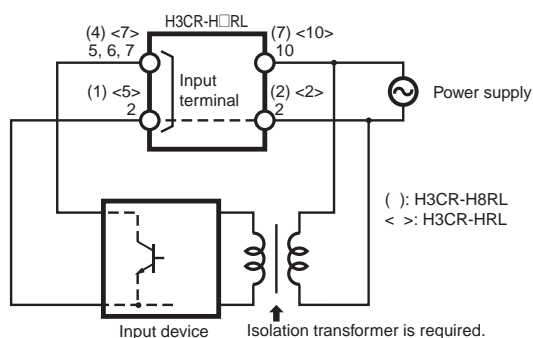

#### Incorrect

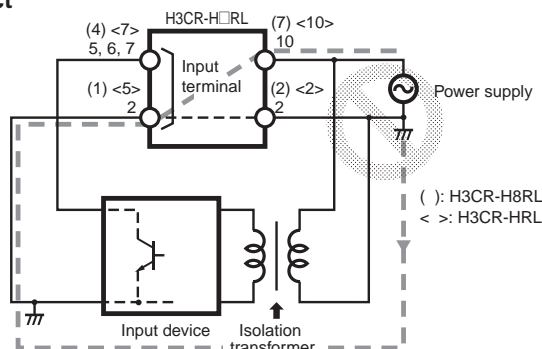

### Input/Output (H3CR-H□RL)

An appropriate input is applied to the input signal terminal of the Timer when the input terminal for the input signal is short-circuited. Do not attempt to connect any input terminal to any terminal other than the input terminal or to apply voltage across other than the specified input terminals or the internal circuits of the Timer may be damaged.

The H3CR-H□RL uses transformerless power supply. When connecting a relay or transistor as an external signal input device, pay attention to the following points to prevent short-circuiting due to a sneak current to the transformerless power supply.

If input is made simultaneously from one input contact or a transistor to the H3CR-H and a Timer whose common input terminals are used as power terminals, such as the H3CR-A, a short-circuit current will be generated. Either input through isolated contacts, or isolate the power supply for one of the Timers.

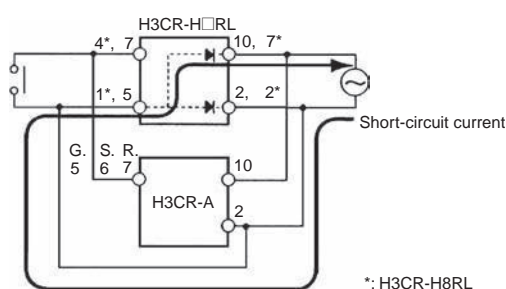

ALL DIMENSIONS SHOWN ARE IN MILLIMETERS.

To convert millimeters into inches, multiply by 0.03937. To convert grams into ounces, multiply by 0.03527.

In the interest of product improvement, specifications are subject to change without notice.

### Wiring

The H3CR-H has a high impedance circuit. Therefore, the H3CR-H may not be reset if the H3CR-H is influenced by inductive voltage. In order to eliminate any influence of inductive voltage, the wires connected to the H3CR-H must be as short as possible and should not be installed alongside power lines. If the H3CR-H is influenced by inductive voltage that is 30% or more of the rated voltage, connect a CR filter with a capacitance of approximately 0.1  $\mu$ F and a resistance of approximately 120  $\Omega$  or a bleeder resistor between the power supply terminals. If there is any residual voltage due to current leakage, connect a bleeder resistor between the power supply terminals.

### Operation

An interval of 3 s minimum is required to turn on the H3CR-H after the H3CR-H is turned off. If the H3CR-H is turned on and off repeatedly with an interval of shorter than 3 s, abnormal heating or burning may occur in internal elements.

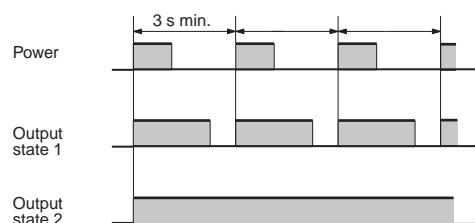

After the forced reset function of the H3CR-H is activated, an interval of 3 s minimum is required to activate the forced reset function again. If the forced reset function is activated repeatedly with an interval of shorter than 3 s, the internal parts of the H3CR-H may deteriorate and the H3CR-H may malfunction.

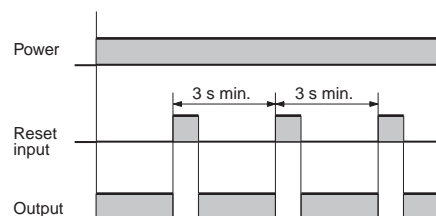

If it is required that the output be turned on repeatedly with an interval of shorter than 3 s, consider use of the H3CR-A in mode D (signal OFF-delay).

On the H3CR-F□, do not set both the ON set dial and OFF set dial to the lowest settings. Doing so may damage the contacts.

### Others

If the H3CR-H is dropped or experiences some other kind of shock, because a latching relay is used for output, contacts may be reversed or go into a neutral state. If the H3CR-H is dropped, reconfirm correct operation.



# Operation (Common)

**Note:** The undermentioned is common for all H3CR models.

## Basic Setting

### Setting of Selectors

The selectors can be turned clockwise and counterclockwise to select the desired time unit, time range, or operating mode. Each selector has a snap mechanism that secures the selector at a given position. Set the selector at a position at which it is secured. Do not set it midway between two securing positions or a malfunction could result from improper setting.

### Selection of Operating Mode

#### • H3CR-A Multifunctional Timer

The operation mode A to E, G, and J of the H3CR-A can be selected. Use a Phillips head or flathead screwdriver to turn the selector switch. The operation mode can be set to one of eight modes. The window on the top shows E, G, J, A, B, B2, C, or D to indicate the selected mode. On the H3CR-A8, the window on the top shows E, J, B, A, or B2.

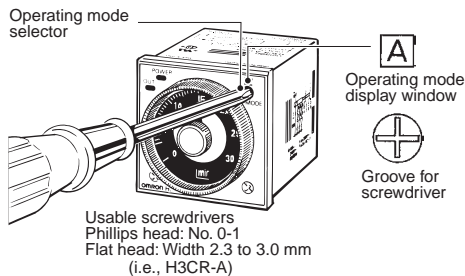

### Selection of Time Unit and Time Range

#### • H3CR-A Multifunctional Timer

The desired time unit (sec,  $\times 10$  s, min,  $\times 10$  m, hrs, or  $\times 10$  h) is displayed in the window below the time setting knob by turning the time unit selector located at the lower right corner of the front panel. A time range (1.2, 3, 12, or 30 for H3CR-A□/2.4, 6, 24, or 60 for H3CR-A□-301) is selected with the time range selector at the lower left corner of the front panel, and the selected time range appears (in the window at the lower right part) within the plastic frame of the time setting knob.

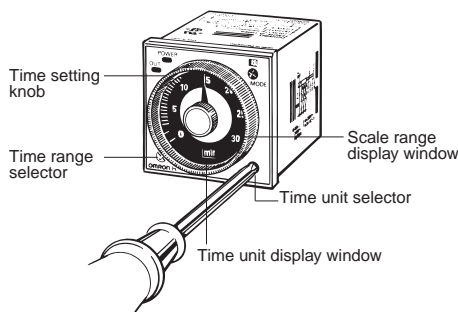

#### • H3CR-F Twin Timers

The display window at the bottom right inside the Time setting knob shows 1.2, 3, 12, or 30 to indicate the scale number selected with the selector switch on the front at bottom left.

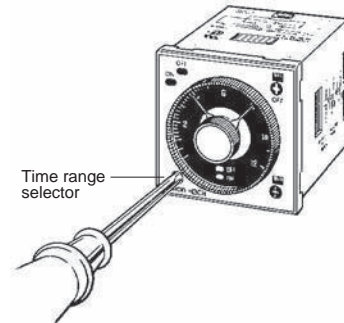

Use a Phillips head or flathead screwdriver to turn the selector switch. For ON-time, the desired time unit (sec, 10 s, min, 10 min, hrs, and 10 h) is indicated in the ON-time unit display window at the lower right corner of the front panel and can be changed by turning the ON-time unit selector located below the ON-time unit display window.

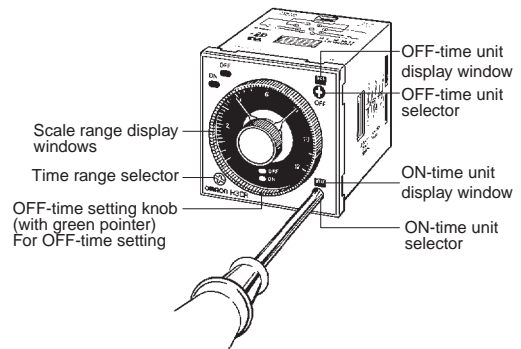

For OFF-time, the desired time unit (sec, 10 s, min, 10 min, hrs and 10 h) is indicated in the OFF-time unit display window at the upper right corner of the front panel and can be changed by turning the OFF-time unit selector located below the OFF-time unit display window.

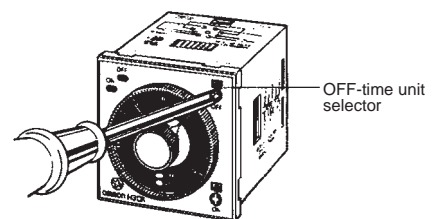

# H3CR

## • H3CR-G Star-delta Timers

The display window at the bottom right inside the Time setting knob shows 6, 12, 60, or 120 to indicate the scale number Star operation time selected with the selector switch on the front at bottom left.

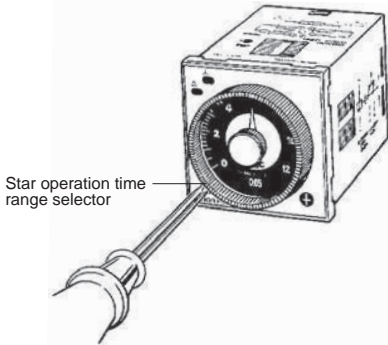

Use a Phillips head screwdriver or flathead screwdriver to turn the selector switch. The display window at the bottom center of the Time setting knob shows 0.05, 0.1, 0.25, 0.5, 0.75, or 1.0 to show the star-delta transfer time selected with the selector switch on the front at bottom right.

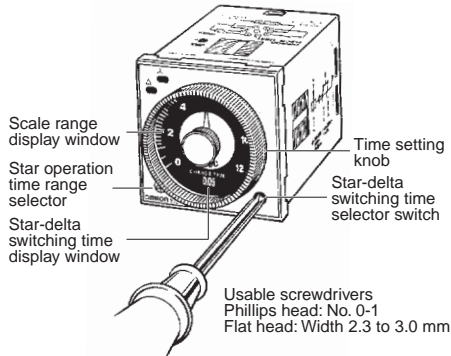

## • H3CR-H Power OFF-delay Timers

Use a Phillips head screwdriver or flathead screwdriver to turn the selector switch. The display window at the bottom right inside the Time setting knob shows 0.6, 1.2, 6, or 12 to indicate the scale number selected with the selector switch on the front at bottom left.

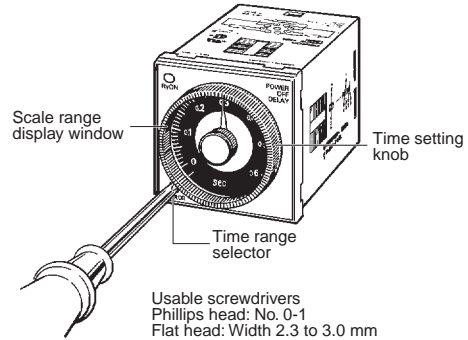

## Setting of Time

Use the time setting knob to set the desired time.

## ■ Using the Time Setting Ring for H3CR-A/-G

### Locking the Set Time

Mount the Panel Cover on the Timer, set the desired time with the time setting knob, and place Time Setting Ring A onto the time setting knob so that the time setting notch of Time Setting Ring A is in the center of the reset lock position of the Panel Cover.

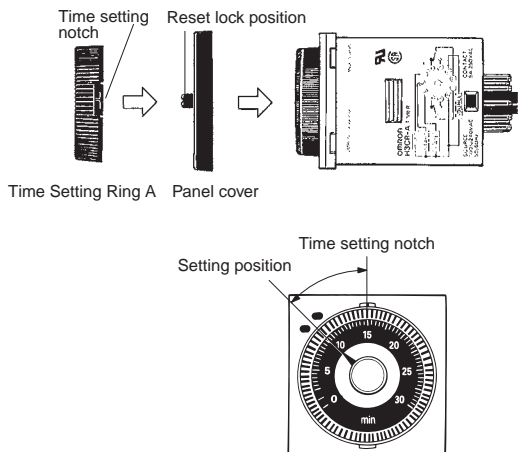

### Limiting the Setting Range

Example: To set a range of 10 and 20 s.  
Mount the Panel Cover on the Timer, set the time setting knob to 10 s (the lower limit of the setting range), and place Time Setting Ring C onto the time setting knob so that the stopper of Time Setting Ring C is on the right edge of the reset lock position of the Panel cover. Next, set the time setting knob to 20 s (the upper limit of the setting range), place Time Setting Ring B onto the time setting knob so that the stopper of Time Setting Ring B is on the left edge of the reset lock position of the Panel Cover.

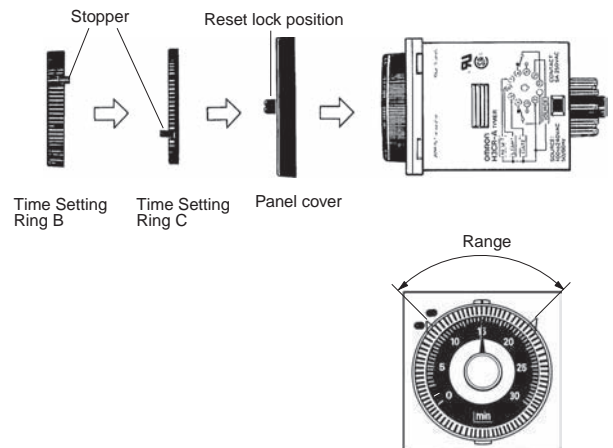

# Accessories (Order Separately) (Common)

**Note:** The undermentioned is common for all H3CR models.

**Note:** All units are in millimeters unless otherwise indicated.

## Flush Mounting Adaptor

### Y92F-30

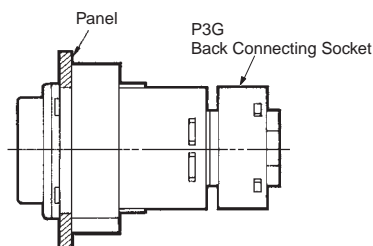
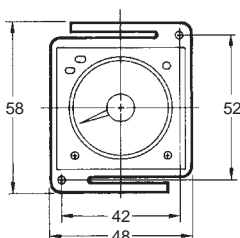
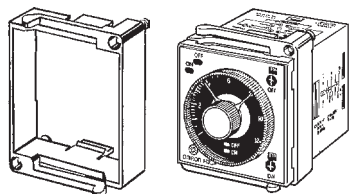

**Note1:** The adapters for two or more timers mounted in a vertical line are different in orientation from those mounted in a horizontal line.

N can be obtained as follows (n: the number of H3CR models arranged side by side)

Without a Cover:  $N = (48n - 2.5)^{+1/-0}$

With the Protective Cover:  $N = (51n - 5.5)^{+1/-0}$

With the Panel Cover:  $N = (50n - 4.5)^{+1/-0}$

**Note2:** The applicable thickness of the mounting panel must be 1 to 5 mm.

### Panel Cutout (Conforms to DIN 43700)

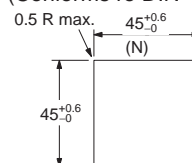

### Y92F-70/-73

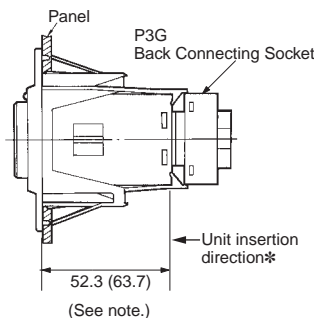
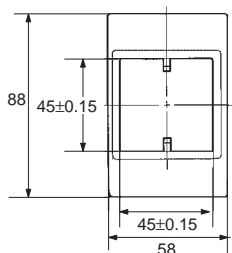
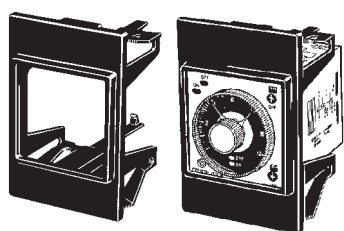

### Panel Cutout

Adapter mounting hole Two, 4.5 dia.

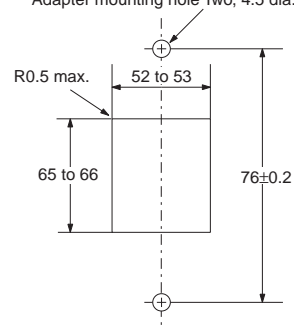

**Note:** The value shown in parentheses is for the Y92F-70.

**Note:** The applicable thickness of the mounting panel must be 1 to 3.2 mm.

\* Insert timer unit from back side of adaptor.

### Y92F-71/-74

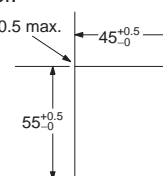
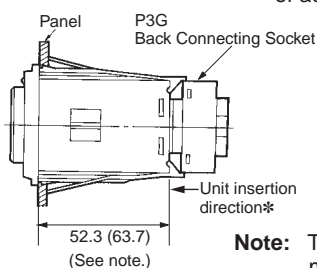
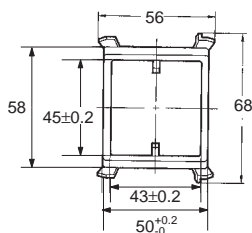
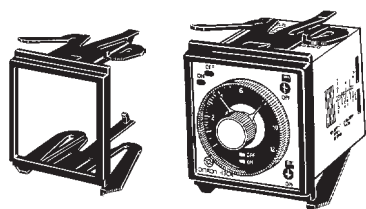

**Note:** The value shown in parentheses is for the Y92F-71.

**Note:** The applicable thickness of the mounting panel must be 1 to 3.2 mm.

\* Insert timer unit from back side of adaptor.

# H3CR

## Track Mounting/Front Connecting Socket

### P2CF-08

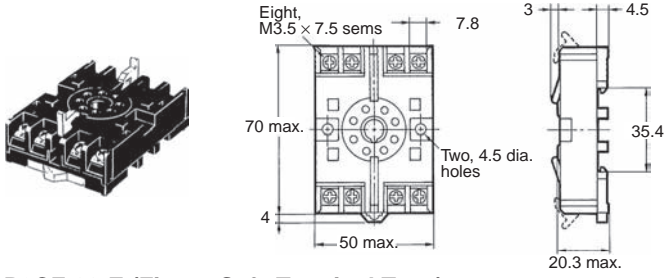

Terminal Arrangement/  
Internal Connections  
(Top View)

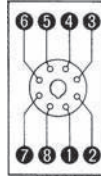

Surface Mounting Holes

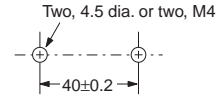

### P2CF-08-E (Finger Safe Terminal Type) Conforming to VDE0106/P100

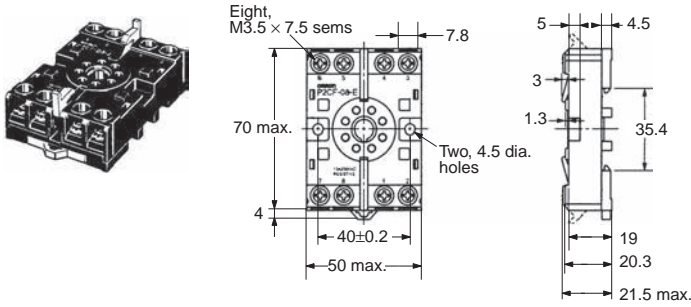

## Track Mounting/Front Connecting Socket

### P2CF-11

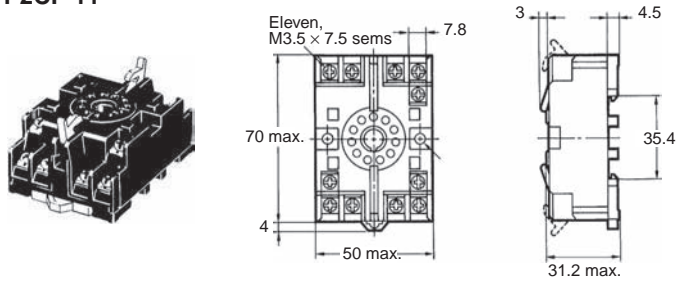

Terminal Arrangement/  
Internal Connections  
(Top View)

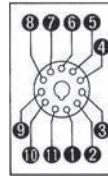

Surface Mounting Holes

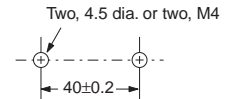

### P2CF-11-E (Finger Safe Terminal Type) Conforming to VDE0106/P100

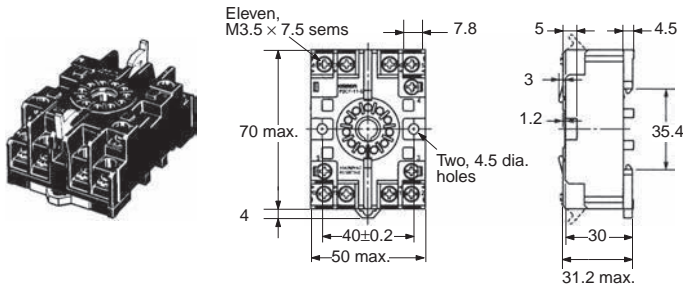

## Back Connecting Socket

P3G-08

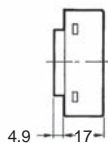
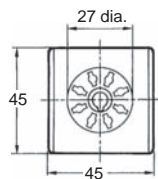
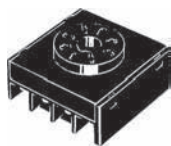

Terminal Arrangement/  
Internal Connections  
(Bottom View)

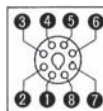

P3GA-11

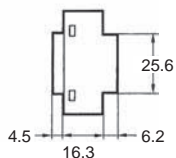
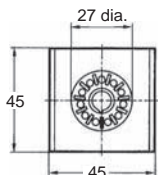
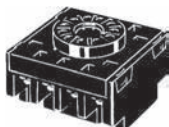

Terminal Arrangement/  
Internal Connections  
(Bottom View)

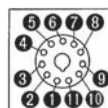

## Finger Safe Terminal Cover

Conforming to VDE0106/P100

Y92A-48G

(Attachment for P3G-08/P3GA-11  
Socket)

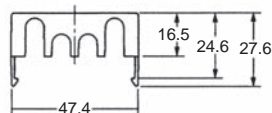
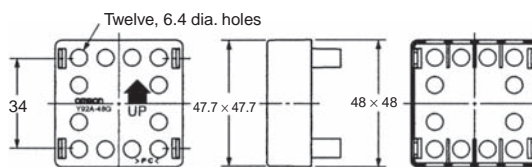
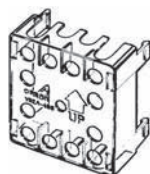

## Mounting Track

PFP-100N, PFP-50N

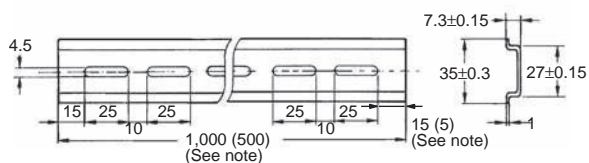
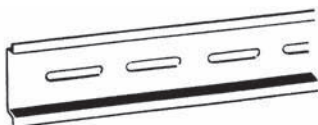

PFP-100N2

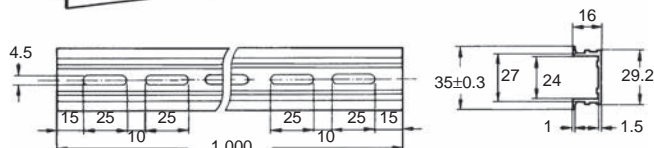

**Note:** The values shown in parentheses are for the PFP-50N.

## End Plate

PFP-M

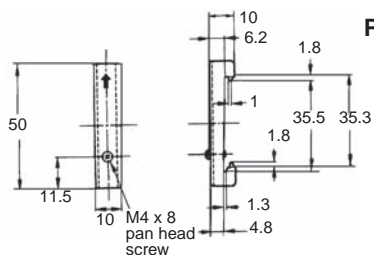

## Spacer

PFP-S

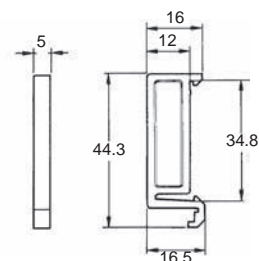
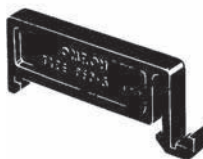



# H3CR

## Time Setting Ring/Panel Cover for H3CR-A/-G

There are two types of Panel Covers (Y92P-48GL, and Y92P-48GB), all of which are available in two colors. Use the most suitable type of Panel Cover with the design of the scaling plate according to the application.

To lock the set time, you can lock the setting dial by using a Y92S-27 Setting Ring and a Y92P-48GL/-48GB Panel Cover. This will help to prevent the set time from being changed accidentally.

To restrict the set time range, you can restrict the rotating range of the setting dial by using a Y92S-28 Setting Ring and a Y92P-48GL/-48GB Panel Cover. Use them to restrict the upper and lower limits of the setting range.

Refer to *Using the Time Setting Ring for H3CR-A/-G* on page 53 for the procedure to attach the Setting Ring.

The Flush Mounting Adapter Y92F-70/Y92F-71 for H3CR-G, Y92F-73/Y92F-74 for H3CR-A or the Protective Cover cannot be used.

**Note:** The Time Setting Ring/Panel Cover cannot be used for H3CR-F model or H3CR-H model.

The Time Setting Ring and Panel Cover should be used as a pair.

<b>Locking the Set Time</b>	Time Setting Ring A (Y92S-27) and Panel Cover (Y92P-48GL, or -48GB)
<b>Limiting the setting range</b>	Time Setting Ring B or C (Y92S-28), and Panel Cover (Y92P-48GL, or -48GB)

**Y92S-27**  
Time Setting A



**Y92S-28**  
Time Setting B



**Y92S-28**  
Time Setting C



**Y92P-48GL**  
Light Gray

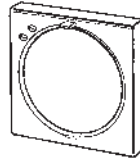

**Y92P-48GB**  
Black



# Safety Precautions for All H3CR Models

**Note:** The undermentioned is common for all H3CR models.

## Warning Indications

 <b>CAUTION</b>	Indicates a potentially hazardous situation which, if not avoided, may result in minor or moderate injury or in property damage.
<b>Precautions for Safe Use</b>	Supplementary comments on what to do or avoid doing, to use the product safely.
<b>Precautions for Correct Use</b>	Supplementary comments on what to do or avoid doing, to prevent failure to operate, malfunction or undesirable effect on product performance.





In rare circumstances there is a risk of slight electrical shock, fire, or device damage. Do not disassemble, modify, repair, or otherwise touch the inside.



In rare circumstances there is a risk of fire if the screws become loose. Tighten the terminal screws to the specified torque (1.08N·m).



## Meaning of Product Safety Symbols

	Used to warn of the risk of electric shock under specific conditions.
	Used for general prohibitions for which there is no specific symbol.
	Use to indicate prohibitions when there is a risk of minor injury from electrical shock or other source if the product is disassembled.
	Used for general mandatory action precautions for which there is no specified symbol.

### CAUTION

Risk of fire and explosion due to arcing and relay heat generation that accompanies switching. Do not use in an environment where flammable or explosive gas is present.



The H3CR series uses a transformer-less power supply. Exercise full caution as there is a risk of electrical shock if input terminal is touched when power voltage is applied.



The service life of the output relay varies widely depending on switching capacity and switching conditions. Use only within the rated load and electrical life count, based on actual conditions of use. Risk of contact sticking and burning if used past the service life. Always use a load current that does not exceed the rating, and if a heater is used, use a thermal switch in the load circuit.



Do not remove the outer casing.



## Precautions for Safe Use

Do not use the Timer in the following locations.

- Locations with radical temperature changes.
- Locations with high humidity that may result in condensation.
- Locations with excessive vibration or shock.
- Locations with corrosive gas or dust.
- Locations where the Timer is exposed to sprayed water, oil, or chemicals.

Pay the utmost attention not to make mistakes in polarity when wiring the Timer.

Do not connect anything to terminals that are not used.

Risk of internal element damage if a voltage that exceeds the rating is applied.

Using a surge absorber is recommended if surge voltages occur.

The H3CR Series uses a transformerless power supply. Do not touch the input terminals while the supply voltage is applied. otherwise an electric shock may be received.

Verify that the power and output LEDs (LCD) are operating normally. In some usage environments, the LEDs/LCD/ resin components may deteriorate faster than normal, resulting in display failure. Inspect and replace regularly.

When disposing of this product, follow the procedures for disposal of industrial waste that apply in your region.

Verify that the product is the desired product before use.

Exercise caution as the outer casing of the timer may be immersed in organic solvents (thinner, benzene, etc.), strong alkali, or strong acids.

## Precautions for Correct Use

### Changing the Setting

Do not change the time unit, time range, or operation mode while the Timer is in operation, otherwise the Timer may malfunction.

The time unit and time range can be set with the respective selectors turned clockwise or counterclockwise.

The selectors are of notched so that they will snap when they are properly set. Do not set the selectors midway between notches, otherwise the Timer may break or malfunction.

Do not use H3CR-A models (except for H3CR-A□S) in flicker mode at the lowest selector setting, or H3CR-F models at the lowest selector setting. Doing so may result in damage to contacts.

# H3CR

## Power Supplies

A DC power supply can be connected if its ripple factor is 20% or less and the mean voltage is within the rated operating voltage range of the Timer.

An AC power supply can be connected to the power input terminals without regard to polarity. A DC power supply must be connected to the power input terminals as designated according to the polarity of the terminals.

Make sure that the voltage is applied within the specified range, otherwise the internal elements of the Timer may be damaged.

Connect the power supply voltage through a relay or switch in such a way that the voltage reaches a fixed value at once, otherwise the Timer may not be reset or a timer error may result.

Be aware that the operating voltage will rise by 5% if the rated voltage is applied to the Timer continuously while the ambient temperature is close to the maximum permissible ambient temperature.

The power supply circuit of any H3CR-A model (except for H3CR-A□S), H3CR-F 100-to-240-VAC model, and H3CR-G model is a switching circuit. If the power line connected to the power supply circuit has a transformer with high inductance, a counter-electromotive voltage will be induced by the inductance. To suppress the voltage, apply a CR filter to the power supply line.

Apply the power voltage at once through the switch and relay contacts. If not applied at once, power reset may not take place or time-up may occur.

When the power is turned on, a rush current (refer to your OMRON website) may flow briefly and the timer may not start if there is insufficient power capacity. Use a power supply with sufficient capacity.

## Mounting Direction

There are no restrictions to the mounting direction.

## Precautions for EN61812-1 Conformance

The H3CR Series as a built-in timer conforms to EN61812-1 provided that the following conditions are satisfied.

Make sure that no voltage is applied to any terminals before dismantling the Timer from the Socket.

The output section of the H3CR is provided only with basic isolation.

The H3CR itself is designed under the following conditions:

- Overvoltage category III
- Pollution degree 2
- Isolation
  - Operation parts: Reinforced isolation
    - With clearance of 5.5 mm and creepage distance of 5.5 mm at 230 VAC
  - Output: Basic isolation (See note)
    - With clearance of 3 mm and creepage distance of 3 mm at 230 VAC

**Note:** The 11-pin model ensures basic isolation by itself and also ensures basic isolation with the 11-pin model mounted to the OMRON P2CF-11-□ or P3GA-11 Socket.

Connect the two output contacts different in polarity to the loads so that they will be the same in potential.

## Others

If the Timer is mounted to a control board, dismantle the Timer from the control board or short-circuit the control board circuitry before carrying out a voltage withstand test between the electric circuitry and non-charged metal part of the Timer. This protects the internal circuitry of the Timer from damage.

If the timer is left for an extended time at high temperature in the time-up state (internal relay ON), the internal components (electrolytic capacitors, etc.) may deteriorate faster than normal. For this reason, use in combination with a relay, and avoid leaving in the time-up state for an extended time (for example, one month or longer).

### Reference example

Use as shown below.

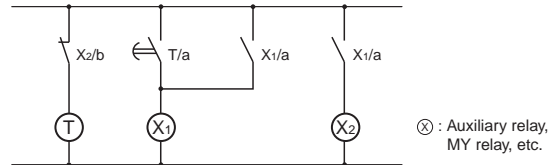

## Cleaning

Do not use solvents such as thinner. Use commercially available alcohol.

ALL DIMENSIONS SHOWN ARE IN MILLIMETERS.

To convert millimeters into inches, multiply by 0.03937. To convert grams into ounces, multiply by 0.03527.

In the interest of product improvement, specifications are subject to change without notice.

# Terms and Conditions Agreement

## Read and understand this catalog.

Please read and understand this catalog before purchasing the products. Please consult your OMRON representative if you have any questions or comments.

## Warranties.

- (a) Exclusive Warranty. Omron's exclusive warranty is that the Products will be free from defects in materials and workmanship for a period of twelve months from the date of sale by Omron (or such other period expressed in writing by Omron). Omron disclaims all other warranties, express or implied.
- (b) Limitations. OMRON MAKES NO WARRANTY OR REPRESENTATION, EXPRESS OR IMPLIED, ABOUT NON-INFRINGEMENT, MERCHANTABILITY OR FITNESS FOR A PARTICULAR PURPOSE OF THE PRODUCTS. BUYER ACKNOWLEDGES THAT IT ALONE HAS DETERMINED THAT THE PRODUCTS WILL SUITABLY MEET THE REQUIREMENTS OF THEIR INTENDED USE.

Omron further disclaims all warranties and responsibility of any type for claims or expenses based on infringement by the Products or otherwise of any intellectual property right. (c) Buyer Remedy. Omron's sole obligation hereunder shall be, at Omron's election, to (i) replace (in the form originally shipped with Buyer responsible for labor charges for removal or replacement thereof) the non-complying Product, (ii) repair the non-complying Product, or (iii) repay or credit Buyer an amount equal to the purchase price of the non-complying Product; provided that in no event shall Omron be responsible for warranty, repair, indemnity or any other claims or expenses regarding the Products unless Omron's analysis confirms that the Products were properly handled, stored, installed and maintained and not subject to contamination, abuse, misuse or inappropriate modification. Return of any Products by Buyer must be approved in writing by Omron before shipment. Omron Companies shall not be liable for the suitability or unsuitability or the results from the use of Products in combination with any electrical or electronic components, circuits, system assemblies or any other materials or substances or environments. Any advice, recommendations or information given orally or in writing, are not to be construed as an amendment or addition to the above warranty.

See <http://www.omron.com/global/> or contact your Omron representative for published information.

## Limitation on Liability; Etc.

OMRON COMPANIES SHALL NOT BE LIABLE FOR SPECIAL, INDIRECT, INCIDENTAL, OR CONSEQUENTIAL DAMAGES, LOSS OF PROFITS OR PRODUCTION OR COMMERCIAL LOSS IN ANY WAY CONNECTED WITH THE PRODUCTS, WHETHER SUCH CLAIM IS BASED IN CONTRACT, WARRANTY, NEGLIGENCE OR STRICT LIABILITY.

Further, in no event shall liability of Omron Companies exceed the individual price of the Product on which liability is asserted.

## Suitability of Use.

Omron Companies shall not be responsible for conformity with any standards, codes or regulations which apply to the combination of the Product in the Buyer's application or use of the Product. At Buyer's request, Omron will provide applicable third party certification documents identifying ratings and limitations of use which apply to the Product. This information by itself is not sufficient for a complete determination of the suitability of the Product in combination with the end product, machine, system, or other application or use. Buyer shall be solely responsible for determining appropriateness of the particular Product with respect to Buyer's application, product or system. Buyer shall take application responsibility in all cases.

NEVER USE THE PRODUCT FOR AN APPLICATION INVOLVING SERIOUS RISK TO LIFE OR PROPERTY OR IN LARGE QUANTITIES WITHOUT ENSURING THAT THE SYSTEM AS A WHOLE HAS BEEN DESIGNED TO ADDRESS THE RISKS, AND THAT THE OMRON PRODUCT(S) IS PROPERLY RATED AND INSTALLED FOR THE INTENDED USE WITHIN THE OVERALL EQUIPMENT OR SYSTEM.

## Programmable Products.

Omron Companies shall not be responsible for the user's programming of a programmable Product, or any consequence thereof.

## Performance Data.

Data presented in Omron Company websites, catalogs and other materials is provided as a guide for the user in determining suitability and does not constitute a warranty. It may represent the result of Omron's test conditions, and the user must correlate it to actual application requirements. Actual performance is subject to the Omron's Warranty and Limitations of Liability.

## Change in Specifications.

Product specifications and accessories may be changed at any time based on improvements and other reasons. It is our practice to change part numbers when published ratings or features are changed, or when significant construction changes are made. However, some specifications of the Product may be changed without any notice. When in doubt, special part numbers may be assigned to fix or establish key specifications for your application. Please consult with your Omron's representative at any time to confirm actual specifications of purchased Product.

## Errors and Omissions.

Information presented by Omron Companies has been checked and is believed to be accurate; however, no responsibility is assumed for clerical, typographical or proofreading errors or omissions.

**OMRON Corporation Industrial Automation Company**

Tokyo, JAPAN

Contact: [www.ia.omron.com](http://www.ia.omron.com)

**Regional Headquarters**

**OMRON EUROPE B.V.**

Wegalaan 67-69-2132 JD Hoofddorp  
The Netherlands  
Tel: (31)2356-81-300/Fax: (31)2356-81-388

**OMRON ELECTRONICS LLC**

One Commerce Drive Schaumburg,  
IL 60173-5302 U.S.A.  
Tel: (1) 847-843-7900/Fax: (1) 847-843-7787

**OMRON ASIA PACIFIC PTE. LTD.**

No. 438A Alexandra Road # 05-05/08 (Lobby 2),  
Alexandra Technopark,  
Singapore 119967  
Tel: (65) 6835-3011/Fax: (65) 6835-2711

**OMRON (CHINA) CO., LTD.**

Room 2211, Bank of China Tower,  
200 Yin Cheng Zhong Road,  
PuDong New Area, Shanghai, 200120, China  
Tel: (86) 21-5037-2222/Fax: (86) 21-5037-2200

Authorized Distributor:

© OMRON Corporation 2013 All Rights Reserved.  
In the interest of product improvement,  
specifications are subject to change without notice.

CSM\_2\_1\_0614  
Cat. No. **L084-E1-07**

Printed in Japan  
0613 (0696)

# Mouser Electronics

Authorized Distributor

Click to View Pricing, Inventory, Delivery & Lifecycle Information:

## Omron:

[H3CR-F8-AC100-240](#) [H3CR-H8L-AC/DC24\(S\)](#) [H3CR-A-AC100-240/DC100-125](#) [Y92P-48GM](#) [H3CR-F8-300-AC100/240](#) [H3CR-A8E AC100-240/DC100-125](#) [H3CR-A8E AC/DC24-48](#) [H3CR-F8 AC/DC24](#) [H3CR-F8N AC100-240](#) [H3CR-H8L AC100-120 S](#) [H3CR-F AC100-240](#) [H3CR-F AC/DC24](#) [H3CR-A8AC24-48/DC12-48](#) [H3CR-A-300 AC24-48/DC12-48](#) [H3CR-A8-301 AC100-240/DC100125](#) [H3CR-A8S AC24-48/DC12-48](#) [H3CR-AS AC24-48/DC12-48](#) [H3CR-F-300 AC100-240](#) [H3CR-F8-300 AC/DC24](#) [H3CR-F8-300 DC12](#) [H3CR-F8 DC12](#) [H3CR-F8N-300 AC100-240](#) [H3CR-F8N-300 DC12](#) [H3CR-F8N AC/DC24](#) [H3CR-F DC12](#) [H3CR-G8EL-31 AC100-120](#) [H3CR-G8EL AC100-120](#) [H3CR-G8EL AC200-240](#) [H3CR-G8L AC100-120](#) [H3CR-G8L AC200-240](#) [H3CR-H8L AC200-240 M](#) [H3CR-H8L AC200-240 S](#) [H3CR-H8L AC/DC24 M](#) [H3CR-H8L DC100-125 S](#) [H3CR-H8RL AC100-120 M](#) [H3CR-H8RL AC100-120 S](#) [H3CR-HRL AC100-120 M](#) [H3CR-HRL AC100-120 S](#) [H3CR-HRL AC/DC24 S](#) [H3CR-FN AC100-240](#) [H3CR-FN DC12](#) [H3CR-F8-AC100-240/DC100-125](#) [H3CR-A-301 AC100-240/DC100-125](#) [H3CR-A8E-AC100-240/DC100-12](#) [H3CR-A8-302 DC24](#) [H3CR-A8 AC24-48/DC12-48](#) [H3CR-AP AC24-48/DC12-48](#) [H3CR-A-301 AC24-48/DC12-48](#) [H3CR-A8-301 AC24-48/DC12-48](#) [H3CR-AP AC100-240/DC100-125](#) [H3CR-A-300-AC100-240/DC100-125](#) [H3CR-A8-AC100-240/DC100-125](#) [H3CR-G8EL-31 AC200-240](#) [H3CR-H8L AC100-120 M](#) [H3CR-F8N AC100-240/DC100-125](#) [H3CR-F AC100-240/DC100-125](#) [H3CR-F8N AC24-48/DC12-48](#) [H3CR-FN AC/DC24](#) [H3CR-F8 AC24-48/DC12-48](#) [H3CR-H8RL AC200-240 S](#) [H3CR-FN-300 AC/DC24](#) [H3CR-H8RL AC/DC24 M](#) [H3CR-HRL AC/DC24 M](#) [H3CR-FN-300 AC100-240](#) [H3CR-H8L DC100-125 M](#) [H3CR-F8N-300 AC/DC24](#) [H3CR-H8RL AC/DC24 S](#) [H3CR-F-300 AC/DC24](#) [H3CR-F8N-DC12](#) [H3CR-F AC24-48/DC12-48](#) [H3CRAAC100240DC100125Q1](#) [H3CRA8EAC100240DC100125Q1](#) [H3CRA8AC100240DC100125Q1](#) [H3CRH8LACDC24SQ1](#) [H3CR-A AC100-240/DC100-125](#) [H3CR-FN AC100-240/DC100-125](#)