

THIS DOCUMENT IS THE PROPERTY OF
KEYSTONE ELECTRONICS CORP. AND
SHALL NOT BE REPRODUCED, DISTRIBUTED
OR USED AS A BASIS FOR MANUFACTURE
WITHOUT PRIOR WRITTEN PERMISSION
FROM KEYSTONE ELECTRONICS CORP.

ACTUAL SIZE

P/N 8810

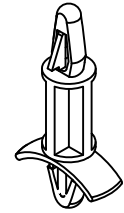
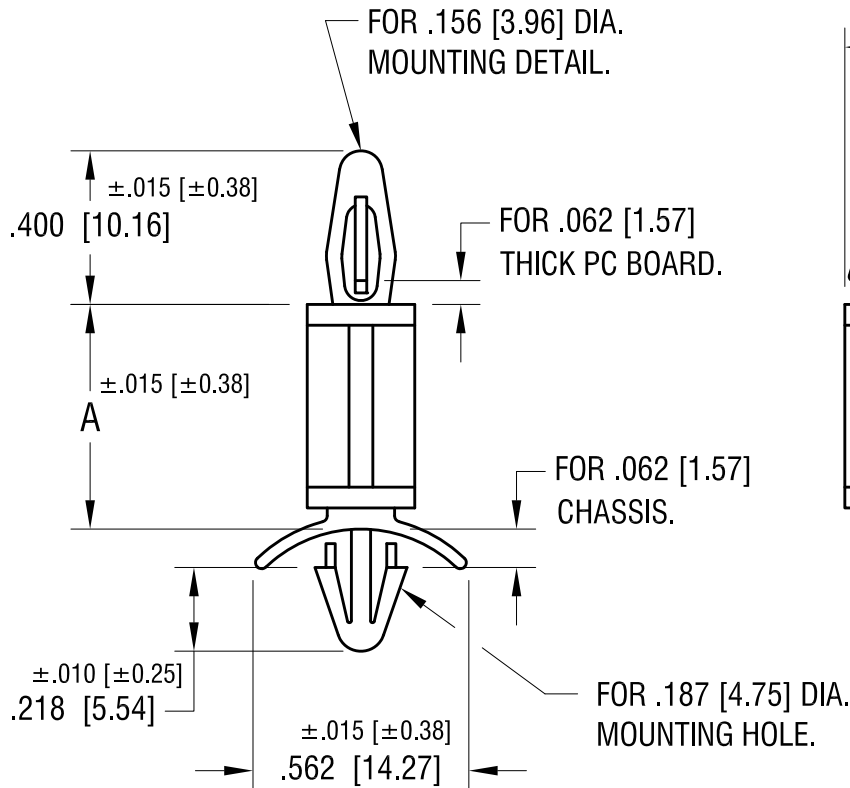

PART NO.	'A' DIM.
8807	.187 [4.74]
8808	.250 [6.35]
8809	.375 [9.52]
8810	.500 [12.70]
8811	.625 [15.87]
8812	.750 [19.05]
8813	.875 [22.22]
8814	1.000 [25.40]

KEYSTONE ELECTRONICS CORP.

www.keyelco.com • NEW HYDE PARK, NY 11040 • Tel (516) 328-7500

PART NAME

PC LOCK-IN SUPPORT

MATERIAL

NYLON UL 94V-0

FINISH

NONE

DRN BY

BOONE

DATE

11.17.95

APP'D

LN

SCALE

2X

7.18.18 CHANGE AS PER ECN 18-028

A

TOLERANCES

INCH [MM]

CODE

DWG NO.

DECIMAL ±.005 [±0.13]

C

ANGULAR ± 1°
UNLESS OTHERWISE SPECIFIED

8807-8814

DATE

DESCRIPTION

REV.

Mouser Electronics

Authorized Distributor

Click to View Pricing, Inventory, Delivery & Lifecycle Information:

[Keystone Electronics:](#)

[8809](#)