

SMF05CT1G, SMF12CT1G, SMF15CT1G, SMF24CT1G, SZSMF12CT1G

ESD Protection Diode Array, 5-Line

This 5-line surge protection array is designed for application requiring transient voltage protection capability. It is intended for use in over-transient voltage and ESD sensitive equipment such as computers, printers, automotive electronics, networking communication and other applications. This device features a monolithic common anode design which protects five independent lines in a single SC-88 package.

Features

- Protects up to 5-Line in a Single SC-88 Package
- Peak Power Dissipation – 100 W (8 x 20 μ s Waveform)
- ESD Rating of Class 3B (Exceeding 8 kV) per Human Body Model and Class C (Exceeding 400 V) per Machine Model.
- Compliance with IEC 61000-4-2 (ESD) 15 kV (Air), 8 kV (Contact)
- Flammability Rating of UL 94 V-0
- SZ Prefix for Automotive and Other Applications Requiring Unique Site and Control Change Requirements; AEC-Q101 Qualified and PPAP Capable
- Pb-Free Packages are Available*

Applications

- Hand-Held Portable Applications
- Networking and Telecom
- Automotive Electronics
- Serial and Parallel Ports
- Notebooks, Desktops, Servers

MAXIMUM RATINGS (T_J = 25°C unless otherwise specified)

Symbol	Rating	Value	Unit
P _{PK 1}	Peak Power Dissipation 8 x 20 μ s Double Exponential Waveform (Note 1)	100	W
T _J	Operating Junction Temperature Range	-40 to 125	°C
T _{STG}	Storage Temperature Range	-55 to 150	°C
T _L	Lead Solder Temperature (10 s)	260	°C
ESD	Human Body Model (HBM)	16000	V
	Machine Model (MM)	400	
	IEC 61000-4-2 Air (ESD)	15000	
	IEC 61000-4-2 Contact (ESD)	15000	

Stresses exceeding those listed in the Maximum Ratings table may damage the device. If any of these limits are exceeded, device functionality should not be assumed, damage may occur and reliability may be affected.

1. Nonrepetitive current pulse per Figure 3.

*For additional information on our Pb-Free strategy and soldering details, please download the ON Semiconductor Soldering and Mounting Techniques Reference Manual, SOLDERRM/D.



ON Semiconductor®

www.onsemi.com

SC-88 FIVE SURGE PROTECTION 100 W PEAK POWER



SC-88
CASE 419B
STYLE 24

PIN ASSIGNMENT

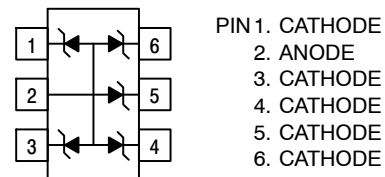

MARKING DIAGRAM

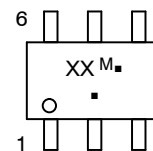

XX = Specific Device Code
6J = SMF05C
6K = SZSMF12C/SMF12C
6L = SMF15C
6M = SMF24C
M = Date Code
■ = Pb-Free Package

ORDERING INFORMATION

See detailed ordering and shipping information in the package dimensions section on page 3 of this data sheet.

SMF05CT1G, SMF12CT1G, SMF15CT1G, SMF24CT1G, SZSMF12CT1G

SMF05CT1G ELECTRICAL CHARACTERISTICS ($T_J = 25^\circ\text{C}$ unless otherwise specified)

Parameter	Symbol	Conditions	Min	Typ	Max	Unit
Reverse Working Voltage	V_{RWM}	(Note 2)			5.0	V
Breakdown Voltage	V_{BR}	$I_T = 1\text{ mA}$, (Note 3)	6.2		7.2	V
Reverse Leakage Current	I_R	$V_{RWM} = 5\text{ V}$		0.07	5.0	μA
Clamping Voltage	V_C	$I_{PP} = 5\text{ A}$ (8 x 20 μs Waveform)			9.8	V
Clamping Voltage	V_C	$I_{PP} = 8\text{ A}$ (8 x 20 μs Waveform)			12.5	V
Maximum Peak Pulse Current	I_{PP}	8 x 20 μs Waveform			8.0	A
Capacitance	C_J	$V_R = 0\text{ V}$, $f = 1\text{ MHz}$ (Line to GND)		80	130	pF

SMF12CT1G ELECTRICAL CHARACTERISTICS ($T_J = 25^\circ\text{C}$ unless otherwise specified)

Parameter	Symbol	Conditions	Min	Typ	Max	Unit
Reverse Working Voltage	V_{RWM}	(Note 2)			12	V
Breakdown Voltage	V_{BR}	$I_T = 1\text{ mA}$, (Note 3)	13.3		15	V
Reverse Leakage Current	I_R	$V_{RWM} = 12\text{ V}$		0.01	0.1	μA
Clamping Voltage	V_C	$I_{PP} = 3\text{ A}$ (8 x 20 μs Waveform)			21	V
Clamping Voltage	V_C	$I_{PP} = 6\text{ A}$ (8 x 20 μs Waveform)			23	V
Maximum Peak Pulse Current	I_{PP}	8 x 20 μs Waveform			6.0	A
Capacitance	C_J	$V_R = 0\text{ V}$, $f = 1\text{ MHz}$ (Line to GND)		40	60	pF

SMF15CT1G ELECTRICAL CHARACTERISTICS ($T_J = 25^\circ\text{C}$, unless otherwise specified)

Parameter	Symbol	Conditions	Min	Typ	Max	Unit
Reverse Working Voltage	V_{RWM}	(Note 2)			15	V
Breakdown Voltage	V_{BR}	$I_T = 1\text{ mA}$, (Note 3)	17		19	V
Reverse Leakage Current	I_R	$V_{RWM} = 15\text{ V}$		0.01	1.0	μA
Clamping Voltage	V_C	$I_{PP} = 1\text{ A}$ (8 x 20 μs Waveform)			23	V
Clamping Voltage	V_C	$I_{PP} = 5\text{ A}$ (8 x 20 μs Waveform)			29	V
Maximum Peak Pulse Current	I_{PP}	8 x 20 μs Waveform			5.0	A
Capacitance	C_J	$V_R = 0\text{ V}$, $f = 1\text{ MHz}$ (Line to GND)		33	45	pF

SMF24CT1G ELECTRICAL CHARACTERISTICS ($T_J = 25^\circ\text{C}$, unless otherwise specified)

Parameter	Symbol	Conditions	Min	Typ	Max	Unit
Reverse Working Voltage	V_{RWM}	(Note 2)			24	V
Breakdown Voltage	V_{BR}	$I_T = 1\text{ mA}$, (Note 3)	26.7		32	V
Reverse Leakage Current	I_R	$V_{RWM} = 24\text{ V}$		0.01	1.0	μA
Clamping Voltage	V_C	$I_{PP} = 1\text{ A}$ (8 x 20 μs Waveform)			40	V
Clamping Voltage	V_C	$I_{PP} = 2.5\text{ A}$ (8 x 20 μs Waveform)			44	V
Maximum Peak Pulse Current	I_{PP}	8 x 20 μs Waveform			2.5	A
Capacitance	C_J	$V_R = 0\text{ V}$, $f = 1\text{ MHz}$ (Line to GND)		21	25	pF

- Surge protection devices are normally selected according to the working peak reverse voltage (V_{RWM}), which should be equal or greater than the DC or continuous peak operating voltage level.
- V_{BR} is measured at pulse test current I_T .
- Include SZ-prefix devices where applicable.

SMF05CT1G, SMF12CT1G, SMF15CT1G, SMF24CT1G, SZSMF12CT1G

TYPICAL PERFORMANCE CURVES

($T_J = 25^\circ\text{C}$ unless otherwise specified)

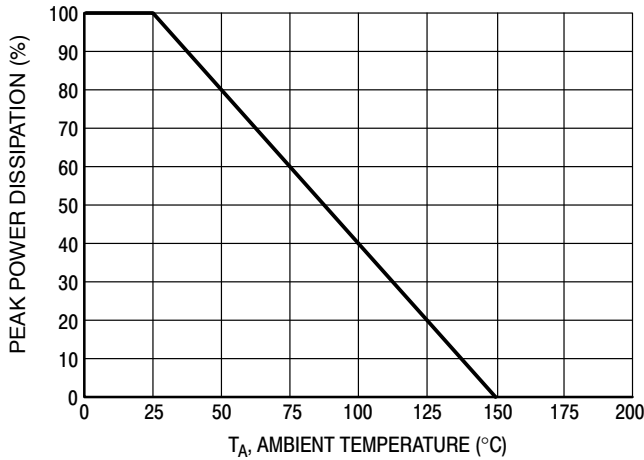

Figure 1. Pulse Derating Curve

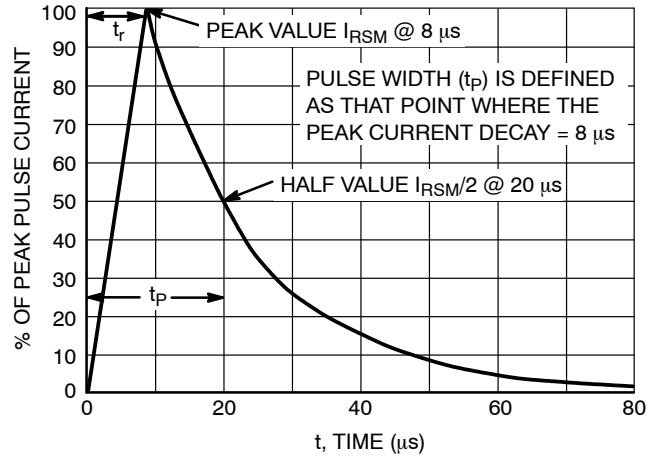

Figure 2. $8 \times 20 \mu\text{s}$ Pulse Waveform

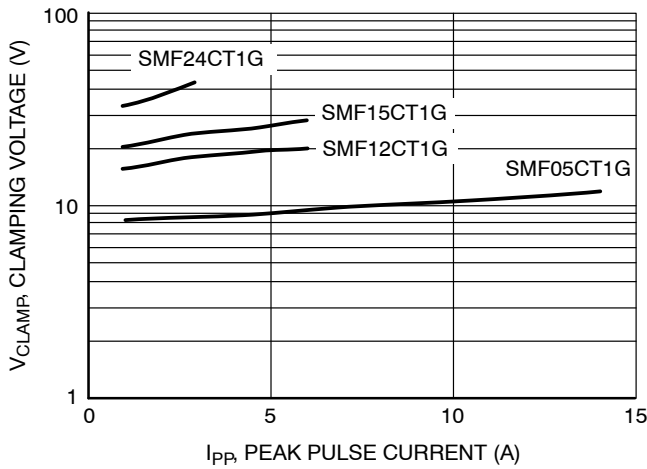

Figure 3. Clamping Voltage vs Peak Pulse Current

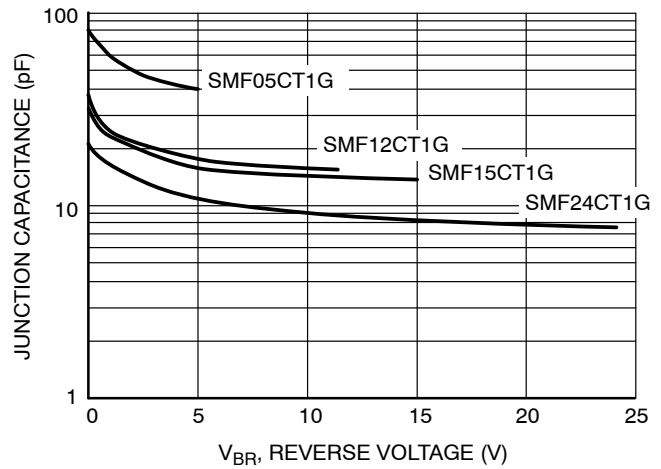

Figure 4. Junction Capacitance vs Reverse Voltage

ORDERING INFORMATION

Device	Package	Shipping†
SMF05CT1G	SC-88 (Pb-Free)	3,000 / Tape & Reel
SMF05CT2G*	SC-88 (Pb-Free)	3,000 / Tape & Reel
SMF12CT1G	SC-88 (Pb-Free)	3,000 / Tape & Reel
SMF15CT1G	SC-88 (Pb-Free)	3,000 / Tape & Reel
SMF24CT1G	SC-88 (Pb-Free)	3,000 / Tape & Reel

†For information on tape and reel specifications, including part orientation and tape sizes, please refer to our Tape and Reel Packaging Specifications Brochure, BRD8011/D.

*The "T2" suffix refers to an alternate tape & reel orientation.

SMF05CT1G, SMF12CT1G, SMF15CT1G, SMF24CT1G, SZSMF12CT1G

PACKAGE DIMENSIONS

SC-88/SC70-6/SOT-363
CASE 419B-02
ISSUE W

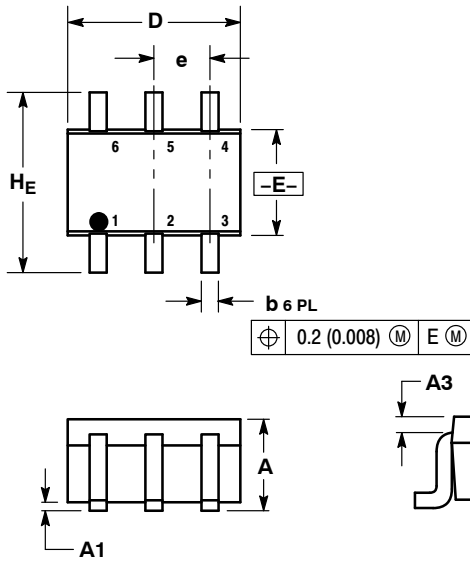

- NOTES:
1. DIMENSIONING AND TOLERANCING PER ANSI Y14.5M, 1982.
2. CONTROLLING DIMENSION: INCH.
3. 419B-01 OBSOLETE, NEW STANDARD 419B-02.

DIM	MILLIMETERS			INCHES		
	MIN	NOM	MAX	MIN	NOM	MAX
A	0.80	0.95	1.10	0.031	0.037	0.043
A1	0.00	0.05	0.10	0.000	0.002	0.004
A3	0.20 REF			0.008 REF		
b	0.10	0.21	0.30	0.004	0.008	0.012
C	0.10	0.14	0.25	0.004	0.005	0.010
D	1.80	2.00	2.20	0.070	0.078	0.086
E	1.15	1.25	1.35	0.045	0.049	0.053
e	0.65 BSC			0.026 BSC		
L	0.10	0.20	0.30	0.004	0.008	0.012
HE	2.00	2.10	2.20	0.078	0.082	0.086

STYLE 24:
PIN 1. CATHODE
2. ANODE
3. CATHODE
4. CATHODE
5. CATHODE
6. CATHODE

SOLDERING FOOTPRINT*

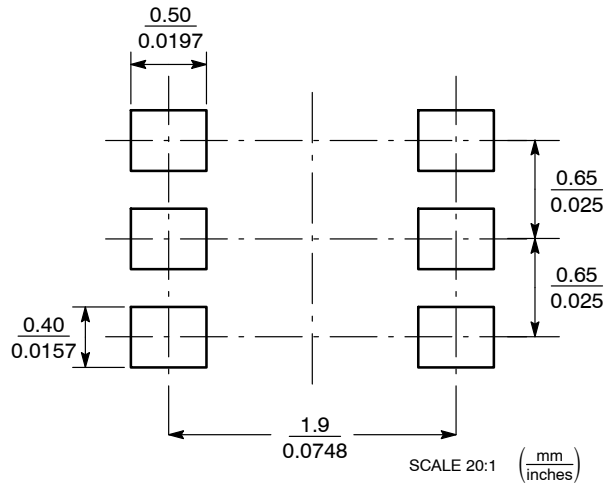

SC-88/SC70-6/SOT-363

*For additional information on our Pb-Free strategy and soldering details, please download the ON Semiconductor Soldering and Mounting Techniques Reference Manual, SOLDERRM/D.

SMF05CT1G, SMF12CT1G, SMF15CT1G, SMF24CT1G, SZSMF12CT1G

ON Semiconductor and  are trademarks of Semiconductor Components Industries, LLC dba ON Semiconductor or its subsidiaries in the United States and/or other countries. ON Semiconductor owns the rights to a number of patents, trademarks, copyrights, trade secrets, and other intellectual property. A listing of ON Semiconductor's product/patent coverage may be accessed at www.onsemi.com/site/pdf/Patent-Marking.pdf. ON Semiconductor reserves the right to make changes without further notice to any products herein. ON Semiconductor makes no warranty, representation or guarantee regarding the suitability of its products for any particular purpose, nor does ON Semiconductor assume any liability arising out of the application or use of any product or circuit, and specifically disclaims any and all liability, including without limitation special, consequential or incidental damages. Buyer is responsible for its products and applications using ON Semiconductor products, including compliance with all laws, regulations and safety requirements or standards, regardless of any support or applications information provided by ON Semiconductor. "Typical" parameters which may be provided in ON Semiconductor data sheets and/or specifications can and do vary in different applications and actual performance may vary over time. All operating parameters, including "Typicals" must be validated for each customer application by customer's technical experts. ON Semiconductor does not convey any license under its patent rights nor the rights of others. ON Semiconductor products are not designed, intended, or authorized for use as a critical component in life support systems or any FDA Class 3 medical devices or medical devices with a same or similar classification in a foreign jurisdiction or any devices intended for implantation in the human body. Should Buyer purchase or use ON Semiconductor products for any such unintended or unauthorized application, Buyer shall indemnify and hold ON Semiconductor and its officers, employees, subsidiaries, affiliates, and distributors harmless against all claims, costs, damages, and expenses, and reasonable attorney fees arising out of, directly or indirectly, any claim of personal injury or death associated with such unintended or unauthorized use, even if such claim alleges that ON Semiconductor was negligent regarding the design or manufacture of the part. ON Semiconductor is an Equal Opportunity/Affirmative Action Employer. This literature is subject to all applicable copyright laws and is not for resale in any manner.

PUBLICATION ORDERING INFORMATION

LITERATURE FULFILLMENT:

Literature Distribution Center for ON Semiconductor
19521 E. 32nd Pkwy, Aurora, Colorado 80011 USA
Phone: 303-675-2175 or 800-344-3860 Toll Free USA/Canada
Fax: 303-675-2176 or 800-344-3867 Toll Free USA/Canada
Email: orderlit@onsemi.com

N. American Technical Support: 800-282-9855 Toll Free
USA/Canada
Europe, Middle East and Africa Technical Support:
Phone: 421 33 790 2910
Japan Customer Focus Center
Phone: 81-3-5817-1050

ON Semiconductor Website: www.onsemi.com
Order Literature: <http://www.onsemi.com/orderlit>
For additional information, please contact your local
Sales Representative

Mouser Electronics

Authorized Distributor

Click to View Pricing, Inventory, Delivery & Lifecycle Information:

ON Semiconductor:

[SMF24CT1G](#) [SZSMF12CT1G](#) [SMF05CT1](#) [SMF05CT1G](#) [SMF05CT2](#) [SMF05CT2G](#) [SMF12CT1](#) [SMF12CT1G](#)
[SMF15CT1](#) [SMF15CT1G](#) [SMF24CT1](#)