

THIS DRAWING IS UNPUBLISHED
 RELEASED FOR PUBLICATION MAR , 2006.
 ALL RIGHTS RESERVED.
 © COPYRIGHT 2009 By -

LOC	DIST	REVISIONS					
		P	LTR	DESCRIPTION	DATE	DWN	APVD
IR	-	B		RELEASED AS PER ECR-09-017658	06AUG09	SRE	PCH
		B1		ECR-10-026537	21JAN11	KK	HMR

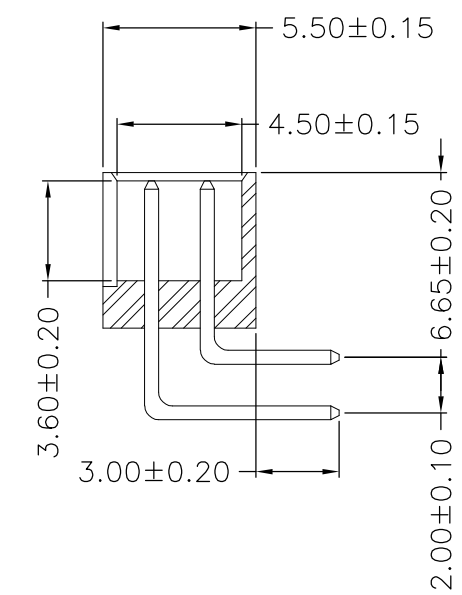

POS.	A	B	C	PART NUMBER	
OBSOLETE	64	62.00	64.85	65.95	6-1734493-4
OBSOLETE	62	60.00	62.85	63.95	6-1734493-2
OBSOLETE	60	58.00	60.85	61.95	6-1734493-0
OBSOLETE	58	56.00	58.85	59.95	5-1734493-8
OBSOLETE	56	54.00	56.85	57.95	5-1734493-6
OBSOLETE	54	52.00	54.85	55.95	5-1734493-4
OBSOLETE	52	50.00	52.85	53.95	5-1734493-2
OBSOLETE	50	48.00	50.85	51.95	5-1734493-0
OBSOLETE	48	46.00	48.85	49.95	4-1734493-8
OBSOLETE	46	44.00	46.85	47.95	4-1734493-6
OBSOLETE	44	42.00	44.85	45.95	4-1734493-4
OBSOLETE	42	40.00	42.85	43.95	4-1734493-2
OBSOLETE	40	38.00	40.85	41.95	4-1734493-0
OBSOLETE	38	36.00	38.85	39.95	3-1734493-8
OBSOLETE	36	34.00	36.85	37.95	3-1734493-6
OBSOLETE	34	32.00	34.85	35.95	3-1734493-4
OBSOLETE	32	30.00	32.85	33.95	3-1734493-2
OBSOLETE	30	28.00	30.85	31.95	3-1734493-0
OBSOLETE	28	26.00	28.85	29.95	2-1734493-8
OBSOLETE	26	24.00	26.85	27.95	2-1734493-6
OBSOLETE	24	22.00	24.85	25.95	2-1734493-4
OBSOLETE	22	20.00	22.85	23.95	2-1734493-2
OBSOLETE	20	18.00	20.85	21.95	2-1734493-0
OBSOLETE	18	16.00	18.85	19.95	1-1734493-8
OBSOLETE	16	14.00	16.85	17.95	1-1734493-6
OBSOLETE	14	12.00	14.85	15.95	1-1734493-4
OBSOLETE	12	10.00	12.85	13.95	1-1734493-2
OBSOLETE	10	8.00	10.85	11.95	1-1734493-0
OBSOLETE	8	6.00	8.85	9.95	0-1734493-8
OBSOLETE	6	4.00	6.85	7.95	0-1734493-6
OBSOLETE	4	2.00	4.85	5.95	0-1734493-4

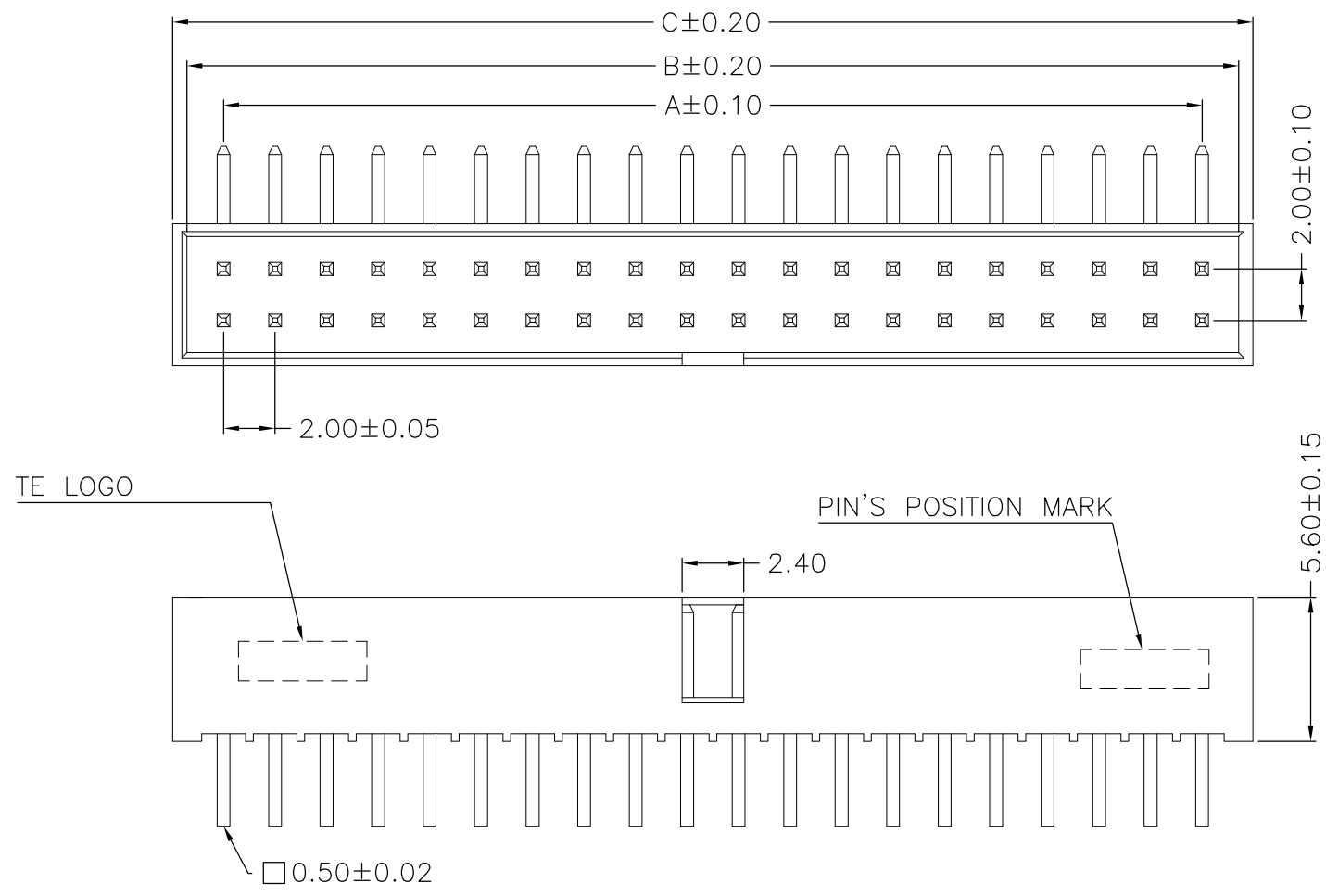
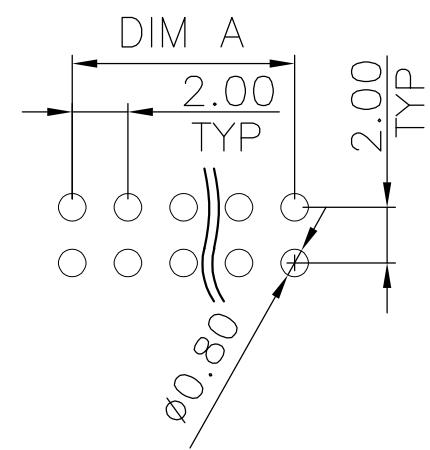

RECOMMENDED PCB LAYOUT (THICKNESS: 1.6mm)
 (TOP VIEW) (TOLERANCE: ±0.05)

- NOTE:
- 1 MATERIAL :
 HOUSING : NYLON 6T, UL94V-0, BLACK COLOUR.
 CONTACT : BRASS, THICKNESS=0.5mm
 - 2 FINISH:
 CONTACT: 10µ" MIN. GOLD PLATED ON CONTACT AREA,
 100µ" MIN. MATTE TIN PLATED ON SOLDERTAILS,
 50µ" MIN. NICKEL UNDERPLATED OVERALL
 - 3. WAVE SOLDER CAPABLE TO 265°C PER TE SPEC 109-202, CONDITION B
 - 4. QUALIFICATION TEST REPORT: 501-57197

THIS DRAWING IS A CONTROLLED DOCUMENT.		DWN	O.HU	28-MAR-2006	TE Connectivity AMPMODU 2.0mm PITCH, RIGHT ANGLE, DUAL ROW, THRU-HOLE					
DIMENSIONS: mm		CHK	S.HOU	28-MAR-2006				NAME		
TOLERANCES UNLESS OTHERWISE SPECIFIED:		APVD	W.J.KE	28-MAR-2006				PRODUCT SPEC		
0 PLC ± - 1 PLC ± 0.20 2 PLC ± 0.15 3 PLC ± 0.10 4 PLC ± - ANGLES ± -		108-57197		APPLICATION SPEC						
MATERIAL		FINISH		WEIGHT	SIZE	CAGE CODE	DRAWING NO	RESTRICTED TO		
1		2		-	A3	-	C-1734493	-		
CUSTOMER DRAWING					SCALE	1:1	SHEET	1 OF 2	REV	B1

THIS DRAWING IS UNPUBLISHED
 RELEASED FOR PUBLICATION MAR , 2006.
 © COPYRIGHT 2009 By - ALL RIGHTS RESERVED.

LOC	DIST	REVISIONS					
IR	-	P	LTR	DESCRIPTION	DATE	DWN	APVD
		-		SEE SHEET 1			

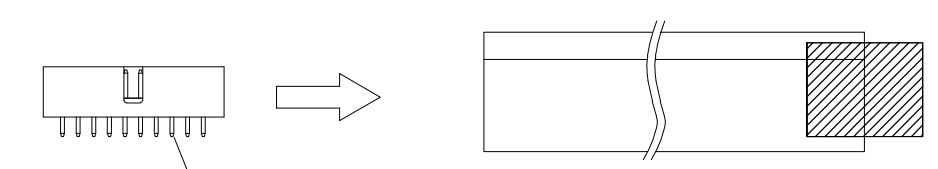

BOX HEADER



TEN PACKAGES OF ONE BUNCH

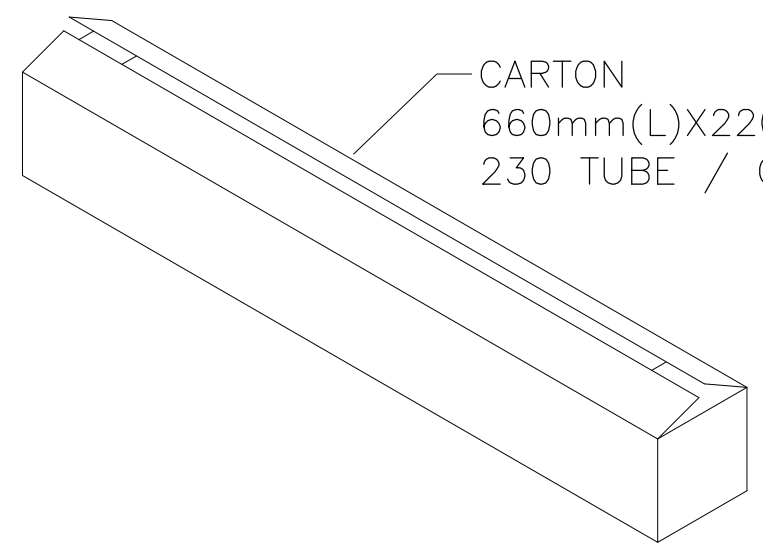

CARTON
 660mm(L)X220mm(W)X140mm(H)
 230 TUBE / CARTON

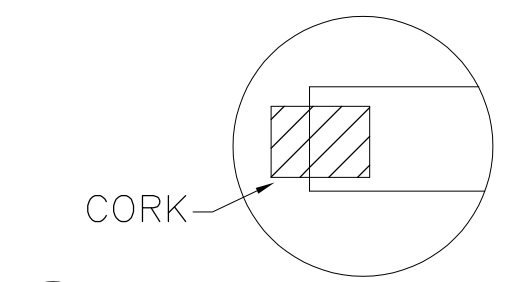

CORK

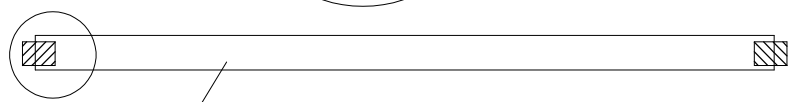

TUBE
 635mm(L)X12mm(W)X11mm(H)
 A / TUBE

OBSOLETE	2,070	9	64	6-1734493-4
	2,070	9	62	6-1734493-2
OBSOLETE	2,070	9	60	6-1734493-0
	2,300	10	58	5-1734493-8
OBSOLETE	2,300	10	56	5-1734493-6
	2,300	10	54	5-1734493-4
OBSOLETE	2,530	11	52	5-1734493-2
	2,530	11	50	5-1734493-0
OBSOLETE	2,760	12	48	4-1734493-8
	2,760	12	46	4-1734493-6
OBSOLETE	2,990	13	44	4-1734493-4
	2,990	13	42	4-1734493-2
OBSOLETE	3,220	14	40	4-1734493-0
	3,450	15	38	3-1734493-8
OBSOLETE	3,450	15	36	3-1734493-6
	3,680	16	34	3-1734493-4
OBSOLETE	3,910	17	32	3-1734493-2
	4,140	18	30	3-1734493-0
OBSOLETE	4,600	20	28	2-1734493-8
	4,830	21	26	2-1734493-6
OBSOLETE	5,290	23	24	2-1734493-4
	5,750	25	22	2-1734493-2
OBSOLETE	6,210	27	20	2-1734493-0
	6,900	30	18	1-1734493-8
OBSOLETE	7,590	33	16	1-1734493-6
	8,510	37	14	1-1734493-4
OBSOLETE	9,660	42	12	1-1734493-2
	11,500	50	10	1-1734493-0
OBSOLETE	13,800	60	8	0-1734493-8
	17,250	75	6	0-1734493-6
OBSOLETE	23,000	100	4	0-1734493-4
	PCS/ CARTON	PCS/ TUBE	POS.	PART NUMBER

THIS DRAWING IS A CONTROLLED DOCUMENT.		DWN	O.HU	28-MAR-2006	 TE Connectivity AMPMODU 2.0mm PITCH, RIGHT ANGLE,DUAL ROW, THRU-HOLE
DIMENSIONS: mm		CHK	S.HOU	28-MAR-2006	
TOLERANCES UNLESS OTHERWISE SPECIFIED:		APVD	W.J.KE	28-MAR-2006	
0 PLC ± - 1 PLC ± 0.20 2 PLC ± 0.15 3 PLC ± 0.10 4 PLC ± - ANGLES ± -		PRODUCT SPEC		NAME	
MATERIAL		108-57197		APPLICATION SPEC	SIZE
SEE SHEET 1		FINISH		SEE SHEET 1	CAGE CODE
		WEIGHT		-	DRAWING NO
		CUSTOMER DRAWING			RESTRICTED TO
		SCALE		1:1	SHEET
		SHEET		2 OF 2	REV
		REV		B1	

Mouser Electronics

Authorized Distributor

Click to View Pricing, Inventory, Delivery & Lifecycle Information:

[TE Connectivity:](#)

[2-1734493-0](#)