

ANTI-VANDAL SWITCHES
 DETECTOR SWITCHES
 DIP SWITCHES
 KEYLOCK SWITCHES
 NAVIGATION SWITCHES
 PUSHBUTTON SWITCHES
 ROCKER SWITCHES
 ROTARY SWITCHES
 SLIDE SWITCHES
 SNAP ACTION SWITCHES
 TACTILE SWITCHES
 TOGGLE SWITCHES
 CAP OPTIONS

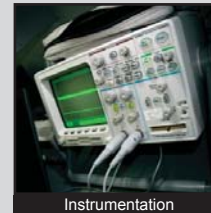

APPLICATIONS / MARKETS

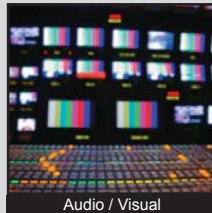

RoHS

SPECIFICATIONS

Electrical Rating: 50mA, 12VDC
Life Expectancy: up to 200,000 Cycles
Contact Resistance: 100mΩ Max.
Insulation Resistance: 100MΩ Min. at 500VDC
Dielectric Strength: 250VAC for 1 Minute
Operating Temperature: -25°C to 70°C
Operating Force: 160gf ± 50gf (200,000 cycles)
 260gf ± 50gf (100,000 cycles)
 320gf ± 80gf, 520 ± 130gf (50,000 cycles)
Travel: 0.35mm ± 0.10mm
Function: SPST, Off-(On), Momentary

FEATURES & BENEFITS

- Up to 200,000 cycle life expectancy
- Multiple actuator options
- Multiple force options

PART NUMBER CONFIGURATOR

Series	Model	Actuator (L Dimension)	Force	Plating
TL	3300	A - 7.30 (3.8mm Sq.) C - 8.50 D - 4.30	F160 - 160 grams F260 - 260 grams F320 - 320 grams F520 - 520 grams	Q - Silver

Specifications subject to change without notice



E-SWITCH®



www.e-switch.com

800.867.2717

1

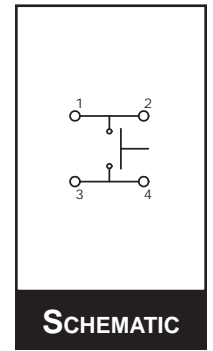
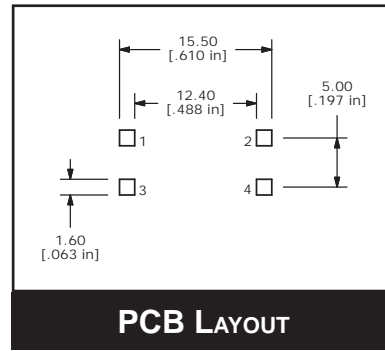

- ANTI-VANDAL SWITCHES
- DETECTOR SWITCHES
- DIP SWITCHES
- KEYLOCK SWITCHES
- NAVIGATION SWITCHES
- PUSHBUTTON SWITCHES
- ROCKER SWITCHES
- ROTARY SWITCHES
- SLIDE SWITCHES
- SNAP ACTION SWITCHES
- TACTILE SWITCHES
- TOGGLE SWITCHES
- CAP OPTIONS

“A” ACTUATOR

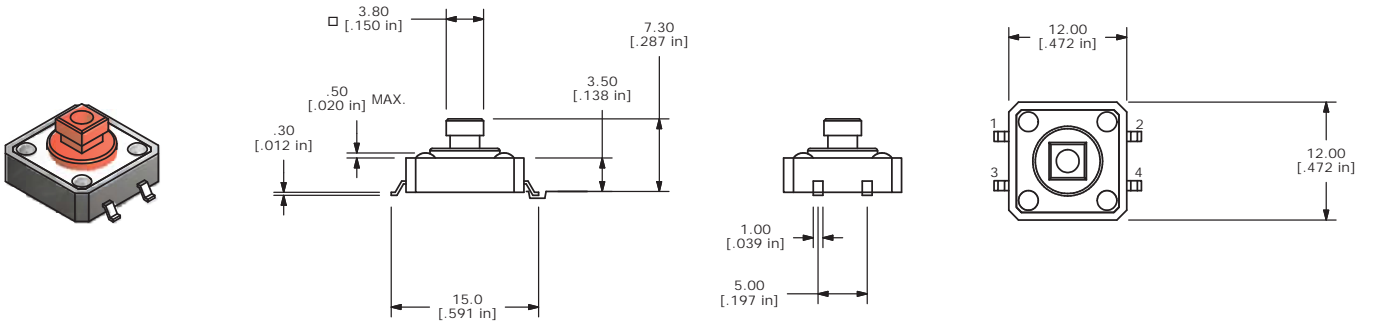

“C” ACTUATOR

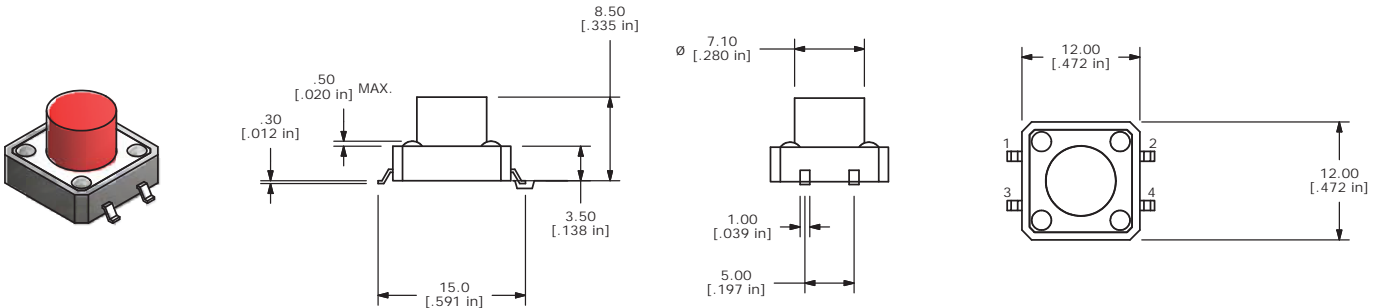

“D” ACTUATOR

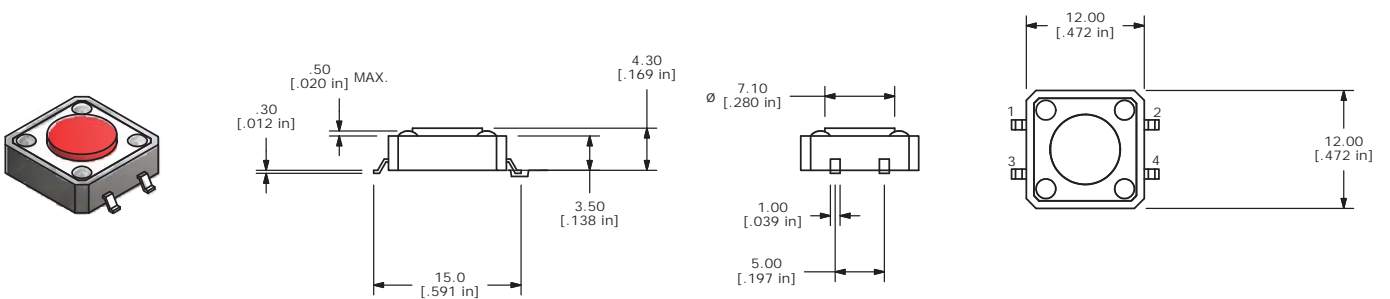

Mouser Electronics

Authorized Distributor

Click to View Pricing, Inventory, Delivery & Lifecycle Information:

E-Switch:

[TL3300AF160Q](#) [TL3300AF160QSSDOME](#) [TL3300AF260Q](#) [TL3300CF160Q](#) [TL3300CF260Q](#) [TL3300DF160Q](#)
[TL3300DF260Q](#) [TL3300DF320Q](#)