

**PLEASE CHECK WWW.MOLEX.COM FOR LATEST PART INFORMATION**

**Part Number:** [0430451025](#)  
**Status:** **Active**  
**Overview:** [Micro-Fit 3.0 Connector System Product Family](#)  
**Description:** [Micro-Fit 3.0 Vertical Header, 3.00mm Pitch, Dual Row, 10 Circuits, with PCB Press-fit Metal Retention Clip, Gold, Glow-Wire Capable, Black](#)

**Documents:**

<a href="#">3D Model</a>	<a href="#">Product Specification TS-43045-002-001 (PDF)</a>
<a href="#">Drawing (PDF)</a>	<a href="#">Product Specification TS-46235-001-001 (PDF)</a>
<a href="#">Product Specification PS-43045 (PDF)</a>	<a href="#">Packaging Specification PK-70873-0314-001 (PDF)</a>
<a href="#">Product Specification PS-43045-001 (PDF)</a>	<a href="#">RoHS Certificate of Compliance (PDF)</a>
<a href="#">Product Specification TS-43045-001-001 (PDF)</a>	<a href="#">Product Literature (PDF)</a>

**Agency Certification**

CSA	LR19980
UL	E29179

**General**

Product Family	PCB Headers
Series	<a href="#">43045</a>
Application	Power, Wire-to-Board
Comments	<p>High Temperature Square Pin Offset Through Hole Mounting Solder Type&lt;P&gt;&lt;P&gt;This Molex product is manufactured from material that has the following ratings, tested by independent agencies: a) A Glow Wire Ignition Temperature (GWIT) of at least 775 deg C per IEC 60695-2-13.. b) A Glow Wire Flammability Index (GWFI) above 850 deg C per IEC 60695-2-12.and hence complies with the requirements set out in the International Standard IEC 60335-1 5th edition - household and similar electrical appliances - safety, section 30 Resistance to heat and fire. &lt;P&gt;&lt;P&gt; The customers using this product must determine its suitability for use in their particular application through testing or other acceptable means as described in end-product glow-wire flammability test standard IEC 60695-2-11 and any applicable product end-use standard(s). &lt;P&gt; If it is determined during the customer's evaluation of suitability, that higher performance is required, please contact Molex for possible product options.</p>

Overview	<a href="#">Micro-Fit 3.0 Connector System Product Family</a>
Product Literature Order No	987650-5984
Product Name	Micro-Fit 3.0
UPC	800753826328

**Physical**

Breakaway	No
Circuits (Loaded)	10
Circuits (maximum)	10
Color - Resin	Black
Durability (mating cycles max)	30
Flammability	94V-0
Glow-Wire Capable	Yes
Mated Height	17.64mm
Material - Metal	Brass
Material - Plating Mating	Gold

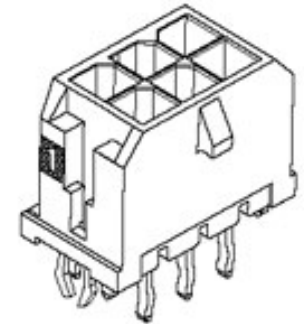

Series image - Reference only

**EU ELV**

**Not Relevant**

**EU RoHS**

**Compliant**

**REACH SVHC**

Not Contained Per - ED/61/2018 (27 June 2018)

**Halogen-Free**

**Status**

**Low-Halogen**

For more information, please visit [Contact US](#)

China ROHS

ELV

RoHS Phthalates

**China RoHS**

Green Image

Not Relevant

Not Contained

**Search Parts in this Series**

[43045 Series](#)

**Mates With**

[Micro-Fit 3.0 Receptacle Housing 43025](#)  
 <br>[Micro-Fit 3.0 TPA Receptacle Housing 172952](#)

Material - Plating Termination	Tin
Material - Resin	High Temperature Thermoplastic
Net Weight	1.552/g
Number of Rows	2
Orientation	Vertical
PCB Locator	Yes
PCB Retention	Yes
PCB Thickness - Recommended	1.60mm
Packaging Type	Tray
Pitch - Mating Interface	3.00mm
Plating min - Mating	0.381µm
Polarized to PCB	Yes
Shrouded	Fully
Stackable	No
Surface Mount Compatible (SMC)	Yes
Temperature Range - Operating	-40° to +105°C
Termination Interface: Style	Through Hole - Kinked Pin

#### Electrical

Current - Maximum per Contact	8.5A
Voltage - Maximum	600V

#### Solder Process Data

Duration at Max. Process Temperature (seconds)	030
Lead-free Process Capability	SMC&WAVE
Max. Cycles at Max. Process Temperature	003
Process Temperature max. C	260

#### Material Info

#### Reference - Drawing Numbers

Packaging Specification	PK-70873-0314-001
Product Specification	PS-43045, PS-43045-001, TS-43045-001-001, TS-43045-002-001, TS-46235-001-001
Sales Drawing	SD-43045-009
Symbol/Footprint Data	SYM-43045-1024, SYM-43045-1024_6

This document was generated on 11/01/2018

**PLEASE CHECK [WWW.MOLEX.COM](http://WWW.MOLEX.COM) FOR LATEST PART INFORMATION**

# Mouser Electronics

Authorized Distributor

Click to View Pricing, Inventory, Delivery & Lifecycle Information:

[Molex:](#)

[43045-1025](#)