

SYMBOL DEFINITION		MISSING SYMBOLS	
A DIMENSION WITHOUT AN INSPECTION REPORT SYMBOL DOES NOT REQUIRE INSPECTION. IT MAY BE CONTROLLED ON THE INDIVIDUAL COMPONENT DRAWING.	TOTAL NO OF INSPECTIONS REQUIRED	NO MISSING SYMBOL NUMBER	
	LAST NO. USED		
		20	13

DWG STATUS					REVISION HISTORY					AUTH			
DATE	STG	REV	IN/P	CHG	ZONE	REVISION HISTORY					DR	APVD	APV2
19DE12	R	D3	-	-	-	CLEARED REV COLUMN & REDRAWN TO PD					420789	AGC	JVM/DGL

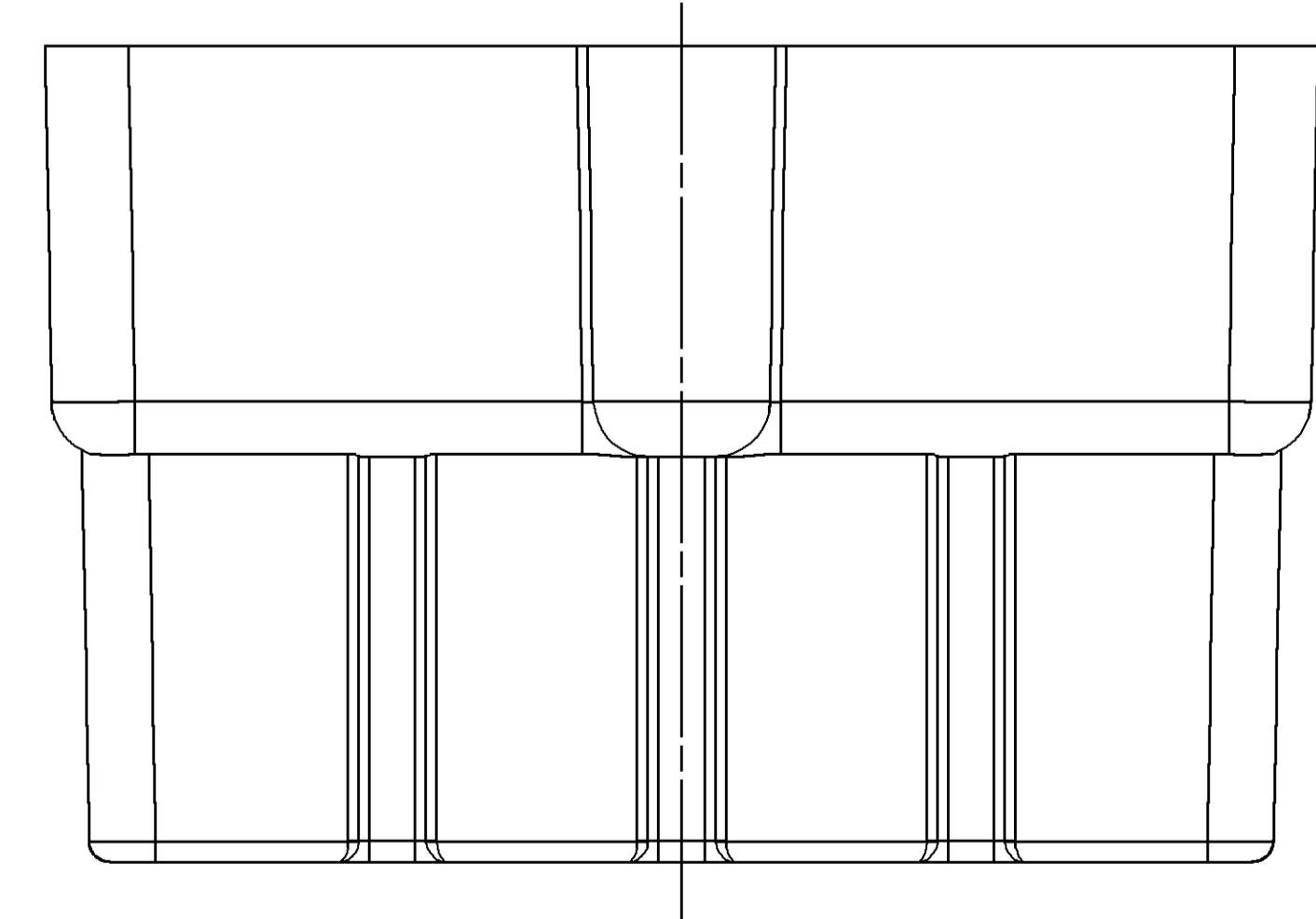
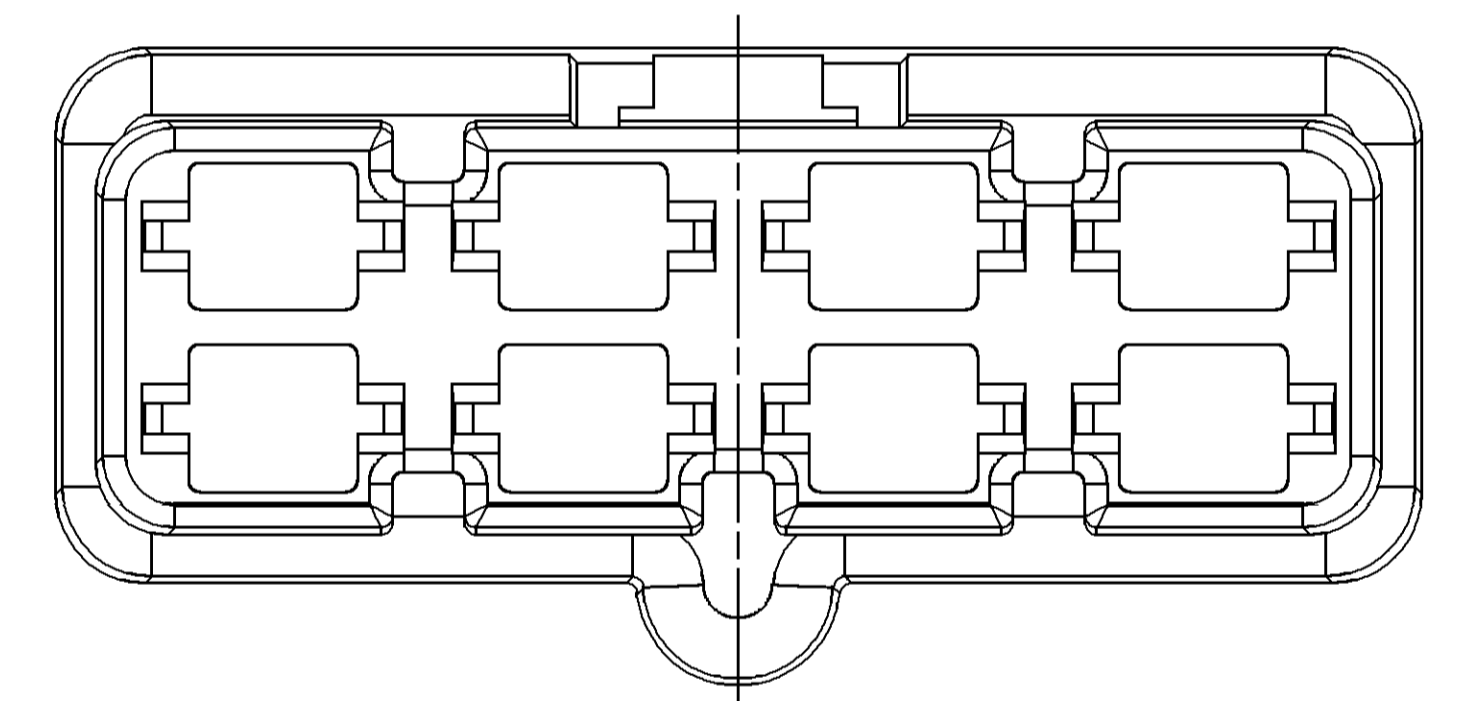
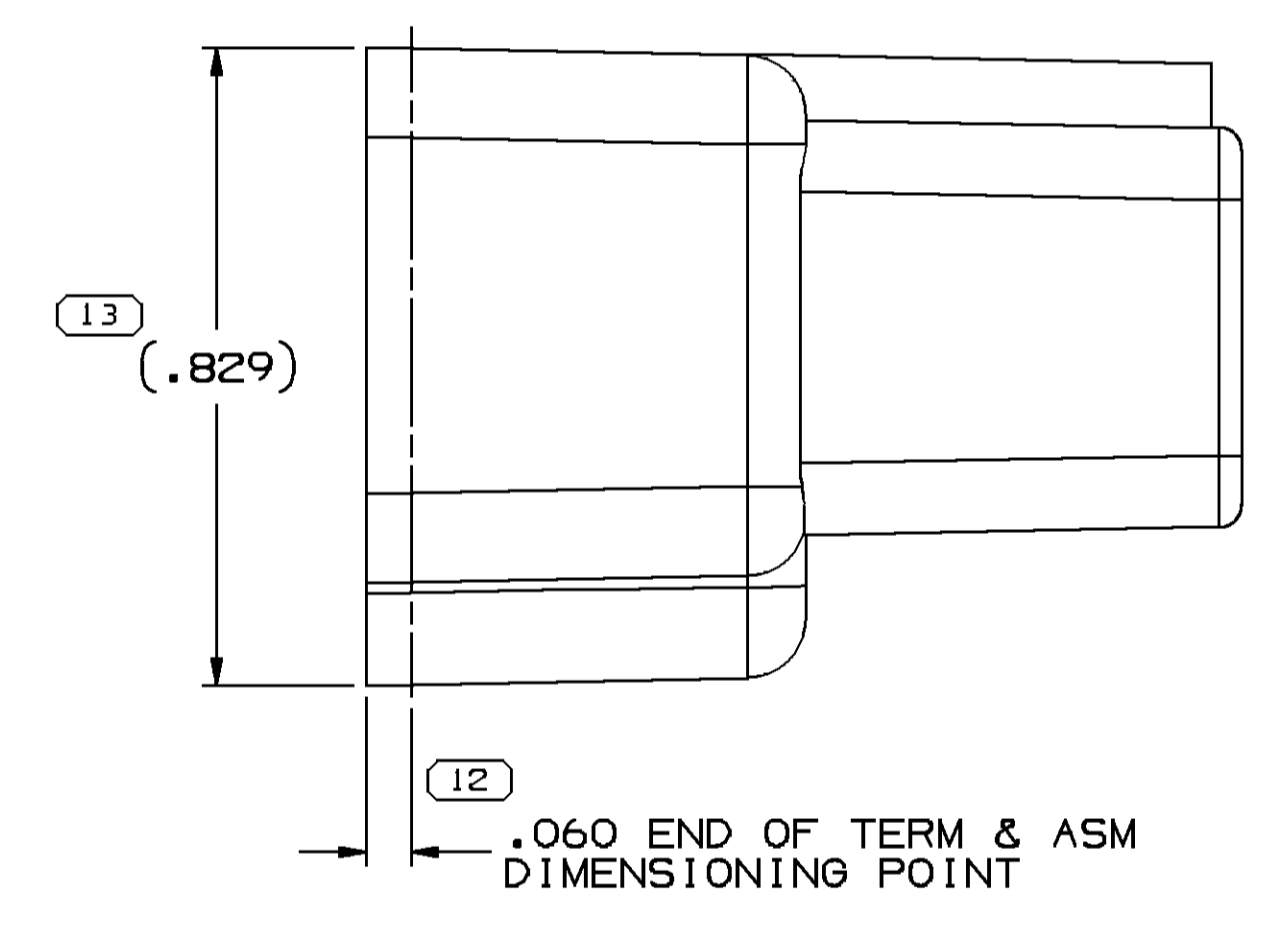
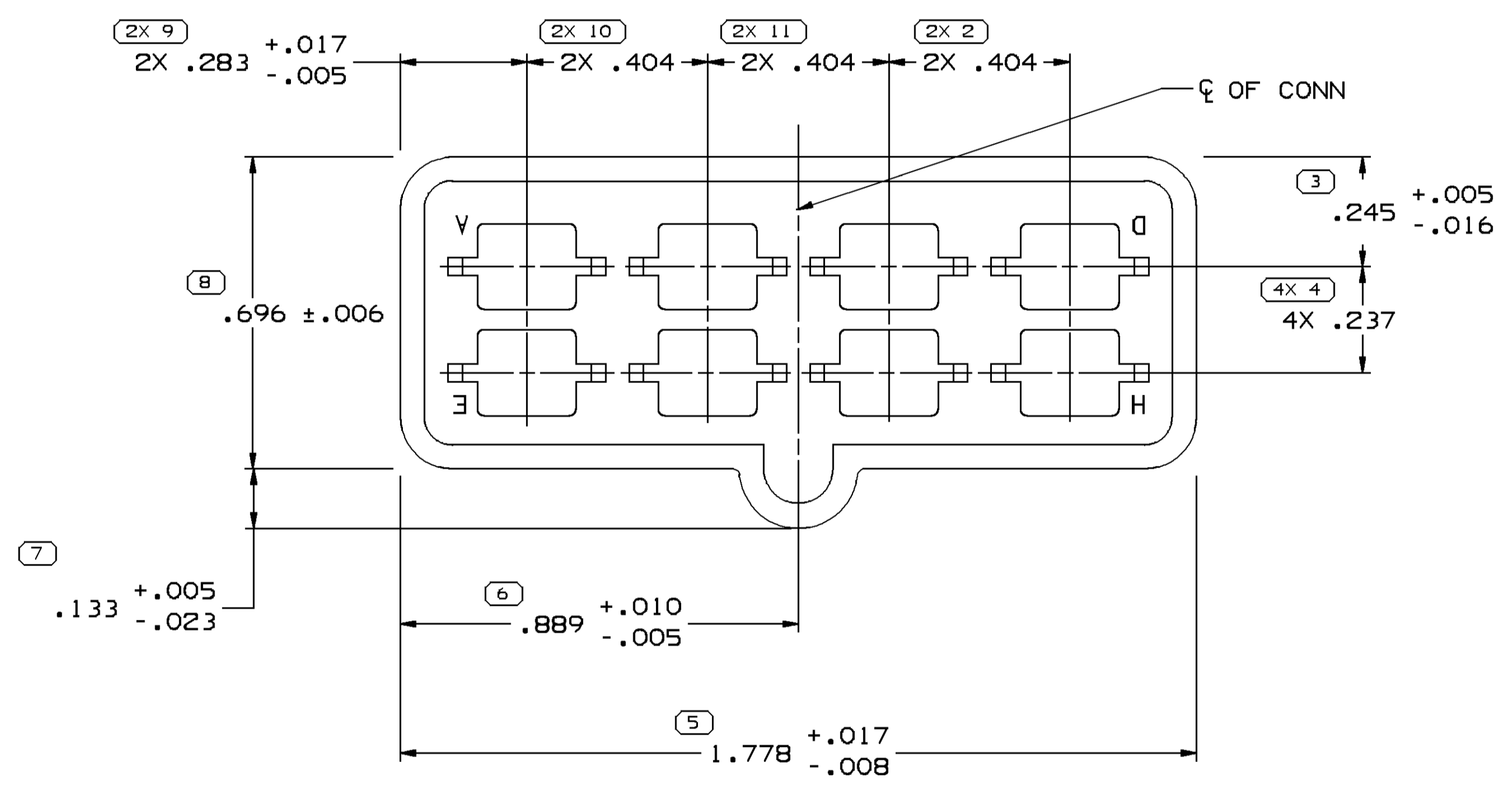
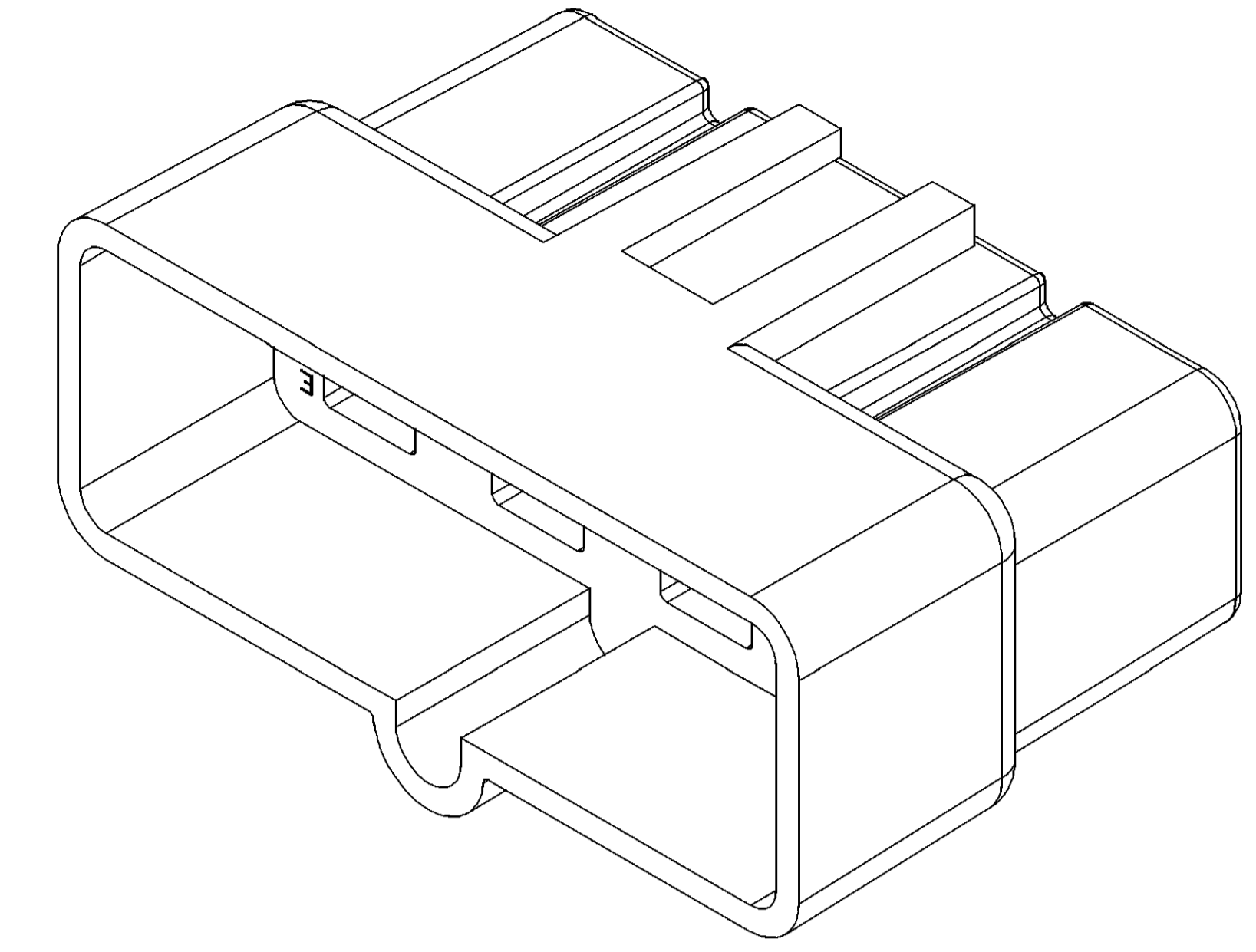
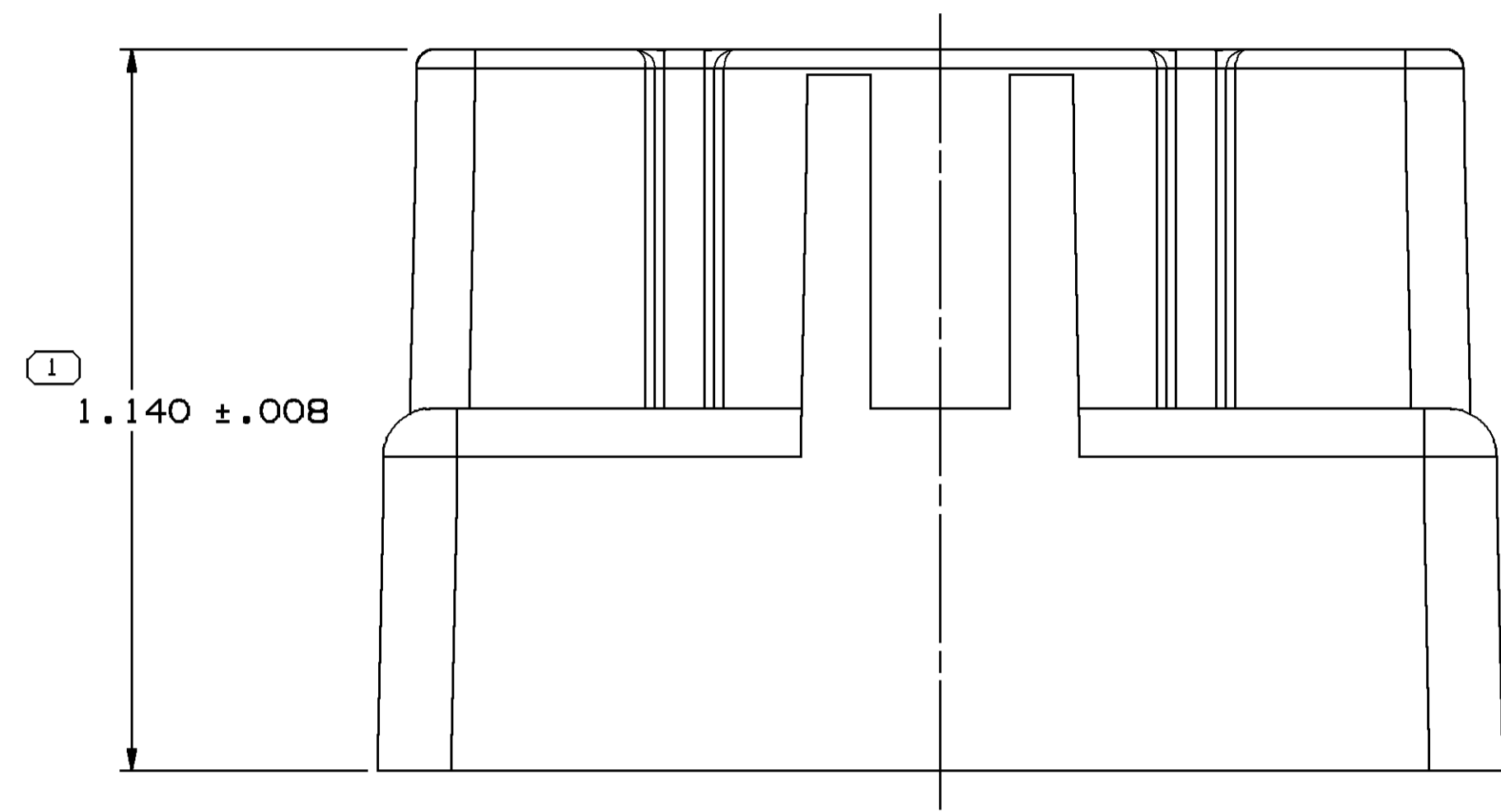

NOTES

- UNLESS OTHERWISE SPECIFIED AND/OR INDICATED:  
DIMENSIONS ARE TO FACE OF VIEW SHOWN AND AUTOMATICALLY ROUNDED BY COMPUTER FOR INSPECTION (SEE MATH MODEL FOR PRECISE DIMENSIONS). FOR ALL OTHER DIMENSIONS NOT SHOWN BUT REQUIRED FOR TOOL BUILD, SEE MATH MODEL FOR PRECISE TOOL PATH DATA.
- MATERIAL RECYCLING CODE PER ISO 11469, (1.0391X(1.003) CHARACTERS AS SHOWN TO BE LOCATED ON ANY EXTERIOR SURFACE. OPTIONAL CONSTRUCTION TO BE NO MATERIAL RECYCLING CODE
- THIS PRODUCT IS NOT CATEGORIZED AS AN APPEARANCE ITEM, MINOR IMPERFECTIONS INCLUDING, BUT NOT LIMITED TO, FLOW MARKS, COLOR BLEMISHES, GATE VESTIGE, AND SOFT FLASH THAT DO NOT AFFECT THE FIT, FORM, OR FUNCTION OF THE PART ARE PERMISSIBLE PER DPNP-4.7-CS-01.
- (1.0391X(1.003) DELPHI CORPORATE BRAND TO BE LOCATED ON ANY EXTERIOR SURFACE, PREFERABLY VISIBLE AT FINAL ASSEMBLY. OPTIONAL CONSTRUCTION FOR EXISTING TOOLING MAY BE "PED" OR NO LOGO.
- CAVITY IDENTIFICATION IS NOT ON PARTS, IT IS JUST SHOWN AS REFERENCE.
- FOR APPLICATION DATA SEE THE APPLICATION DRAWING.

LINE DRAWN THROUGH PART NUMBER INDICATES THAT PHYSICAL PARTS ARE NOT AVAILABLE FOR ORDERING.	
PART NUMBERS THAT DO NOT HAVE A LINE PRESENT INDICATE THAT PHYSICAL PARTS ARE AVAILABLE FOR ORDERING.	
CONTACT DELPHI SALES TO ASSURE AVAILABILITY OF PARTS.	
DWG TYPE	PART DRAWING
STYLE	
VOLUME (OMP)	7.572
DISTR CODE	D
UNLESS OTHERWISE SPECIFIED THIS DOCUMENT IS IN ACCORDANCE WITH ASME Y14.5M-1994 AS MODIFIED BY THE 2003 DIMENSIONING AND TOLERANCING ADDENDUM-2003. SEPARATE PATTERNS OF FEATURES MAY BE SHOWN SEPARATELY IRRESPECTIVE OF DATUM REFERENCES.	
ALL DIMENSIONS ARE IN INCHES	
REFERENCE	

**DELPHI**  
DELPHI PACKARD ELECTRICAL/ELECTRONIC ARCHITECTURE  
WARREN, OH  
COPYRIGHT 1963 DELPHI CORPORATION AND/OR ITS AFFILIATES. ALL RIGHTS RESERVED.  
THIS DRAWING IS THE PROPERTY OF DELPHI CORPORATION AND CONTAINS DELPHI CONFIDENTIAL INFORMATION. THE REPRODUCTION, DISTRIBUTION AND UTILIZATION OF THIS DOCUMENT OR ITS CONTENTS OR DATA, AS WELL AS COMMUNICATION OF ANY CONTENT TO OTHERS, WITHOUT EXPRESS AUTHORIZATION, IS PROHIBITED.

DR	DATE
APV01 LISY	19AP63
APV02 EDWARDS	19AP63
APV03 R.E. KIRK	22AP63
APV04	

SUBSTANCES OF CONCERN AND RECYCLED CONTENT PER DELPHI 10949001

MATERIAL: POLYPROPYLENE COMPOUND NATURAL

DRAWING NUMBER: CONN B M 56 SERIES

DRAWING NUMBER: 02965972

SIZE	SCALE	FRAME NO	SHEET NO	REV	IN/P
A0	4:1	1 OF 1	1 OF 1	R	D3 -

5 PROCESS SENSITIVE DIMENSION	
DIMENSIONS ENCLOSED IN ( ) INDICATE REFERENCE DIMENSIONS AND NO TOLERANCE LIMITS ARE ESTABLISHED	
DIMENSIONAL RANGE (IN)	CHART - II
FROM 0	> .750   > 1.250   > 2.500   > 4.000
TO .750	1.250   2.500   4.000
TOLERANCE UNLESS OTHERWISE SPECIFIED	± .005   ± .010   ± .012   ± .015   ± .020
ANGULAR TOLERANCE ± 2°	

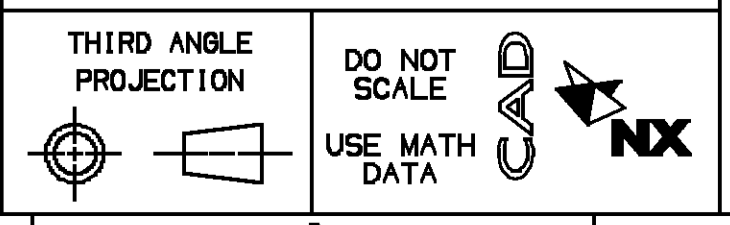

# Mouser Electronics

Authorized Distributor

Click to View Pricing, Inventory, Delivery & Lifecycle Information:

[Aptiv:](#)

[02965972](#)