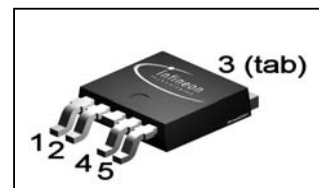

**OptiMOS<sup>®</sup>-P Power-Transistor**
**Features**

- P-Channel
- Enhancement mode
- Logic level
- 175°C operating temperature
- Avalanche rated
- $dv/dt$  rated
- High current rating
- Pb-free lead-plating, RoHS compliant

**PG-TO252-5**

**Product Summary**

$V_{DS}$	-30	V
$R_{DS(on),max}$	7	m $\Omega$
$I_D$	-50	A

Type	Package	Marking	Tape and reel information	Lead Free	Packing
SPD50P03L G	PG-TO252-5	50P03L	1000 pcs / reel	Yes	Non dry

**Maximum ratings, at  $T_j=25\text{ }^\circ\text{C}$ , unless otherwise specified**

Parameter	Symbol	Conditions	Value	Unit
Continuous drain current	$I_D$	$T_C=25\text{ }^\circ\text{C}^{1)}$	-50	A
		$T_C=100\text{ }^\circ\text{C}^{1)}$	-50	
Pulsed drain current	$I_{D,pulse}$	$T_C=25\text{ }^\circ\text{C}$	-200	
Avalanche energy, single pulse	$E_{AS}$	$I_D=-50\text{ A}$ , $R_{GS}=25\text{ }\Omega$	256	mJ
Reverse diode $dv/dt$	$dv/dt$	$I_D=-50\text{ A}$ , $V_{DS}=24\text{ V}$ , $di/dt=-200\text{ A}/\mu\text{s}$ , $T_{j,max}=175\text{ }^\circ\text{C}$	-6	kV/ $\mu\text{s}$
Gate source voltage	$V_{GS}$		$\pm 20$	V
Power dissipation	$P_{tot}$	$T_C=25\text{ }^\circ\text{C}$	150	W
Operating and storage temperature	$T_j, T_{stg}$		-55...+175	$^\circ\text{C}$
ESD class HBM			1C	
Soldering temperature			260	
IEC climatic category; DIN IEC 68-1			55/175/56	

Parameter	Symbol	Conditions	Values			Unit
			min.	typ.	max.	

**Thermal characteristics**

Thermal resistance, junction - case	$R_{thJC}$		-	-	1	K/W
Thermal resistance, junction - ambient	$R_{thJA}$	minimal footprint	-	-	75	
		6 cm <sup>2</sup> cooling area <sup>2)</sup>	-	-	50	

**Electrical characteristics, at  $T_j=25\text{ }^\circ\text{C}$ , unless otherwise specified**
**Static characteristics**

Drain-source breakdown voltage	$V_{(BR)DSS}$	$V_{GS}=0\text{ V}, I_D=-250\text{ }\mu\text{A}$	-30	-	-	V
Gate threshold voltage	$V_{GS(th)}$	$V_{DS}=V_{GS}, I_D=-250\text{ }\mu\text{A}$	-1	-1.5	-2	
Zero gate voltage drain current	$I_{DSS}$	$V_{DS}=-30\text{ V}, V_{GS}=0\text{ V}, T_j=25\text{ }^\circ\text{C}$	-	-0.1	-1	$\mu\text{A}$
		$V_{DS}=-30\text{ V}, V_{GS}=0\text{ V}, T_j=175\text{ }^\circ\text{C}$	-	-10	-100	
Gate-source leakage current	$I_{GSS}$	$V_{GS}=-20\text{ V}, V_{DS}=0\text{ V}$	-	-10	-100	nA
Drain-source on-state resistance	$R_{DS(on)}$	$V_{GS}=-4.5\text{ V}, I_D=-30\text{ A}$	-	8.5	12.5	m $\Omega$
Drain-source on-state resistance	$R_{DS(on)}$	$V_{GS}=-10\text{ V}, I_D=-50\text{ A}$	-	5.7	7.0	
Transconductance	$g_{fs}$	$ V_{DS} >2 I_D R_{DS(on)max}, I_D=-50\text{ A}$	47	94	-	S

<sup>1)</sup> Current is limited by bondwire; with an  $R_{thJC}=1\text{ K/W}$  the chip is able to carry 123 A.

<sup>2)</sup> Device on 40 mm x 40 mm x 1.5 mm epoxy PCB FR4 with 6 cm<sup>2</sup> (one layer, 70  $\mu\text{m}$  thick) copper area for drain connection. PCB is vertical in still air.

Parameter	Symbol	Conditions	Values			Unit
			min.	typ.	max.	

**Dynamic characteristics**

Input capacitance	$C_{iss}$	$V_{GS}=0\text{ V},$ $V_{DS}=-25\text{ V}, f=1\text{ MHz}$	-	4590	6880	pF
Output capacitance	$C_{oss}$		-	1220	1830	
Reverse transfer capacitance	$C_{rss}$		-	1000	1500	
Turn-on delay time	$t_{d(on)}$	$V_{DD}=-15\text{ V},$ $V_{GS}=-10\text{ V}, I_D=-1\text{ A},$ $R_G=6\ \Omega$	-	14.8	22	ns
Rise time	$t_r$		-	21.7	32	
Turn-off delay time	$t_{d(off)}$		-	139	208	
Fall time	$t_f$		-	104	156	

**Gate Charge Characteristics<sup>3)</sup>**

Gate to source charge	$Q_{gs}$	$V_{DD}=-24\text{ V}, I_D=-50\text{ A}$	-	-14	-19	nC
Gate to drain charge	$Q_{gd}$		-	-35	-53	
Gate charge total	$Q_g$	$V_{DD}=-24\text{ V}, I_D=-50\text{ A},$ $V_{GS}=0\text{ to }-10\text{ V}$	-	-95	-126	
Gate plateau voltage	$V_{plateau}$	$V_{DD}=-24\text{ V}, I_D=-50\text{ A}$	-	-3.0	-	V

**Reverse Diode**

Diode continuous forward current	$I_S$	$T_C=25\text{ }^\circ\text{C}$	-	-	-50	A
Diode pulse current	$I_{S,pulse}$		-	-	-200	
Diode forward voltage	$V_{SD}$	$V_{GS}=0\text{ V}, I_F=50\text{ A},$ $T_j=25\text{ }^\circ\text{C}$	-	-1	-1.65	V
Reverse recovery time	$t_{rr}$	$V_R=-15\text{ V}, I_F= I_S ,$ $di_F/dt=100\text{ A}/\mu\text{s}$	-	38	47	ns
Reverse recovery charge	$Q_{rr}$		-	46	57	

<sup>3)</sup> See figure 16 for gate charge parameter definition

**1 Power dissipation**

$$P_{tot} = f(T_C)$$

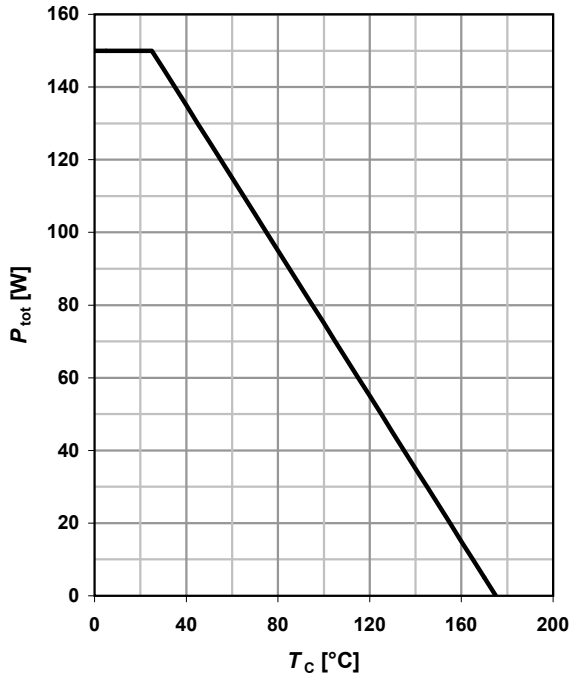

**2 Drain current**

$$I_D = f(T_C); |V_{GS}| \geq 10 \text{ V}$$

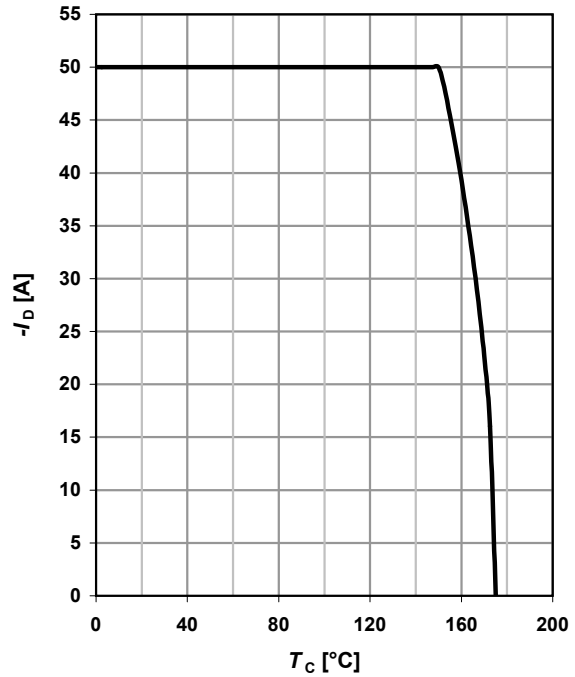

**3 Safe operating area**

$$I_D = f(V_{DS}); T_C = 25 \text{ °C}; D = 0$$

parameter:  $t_p$

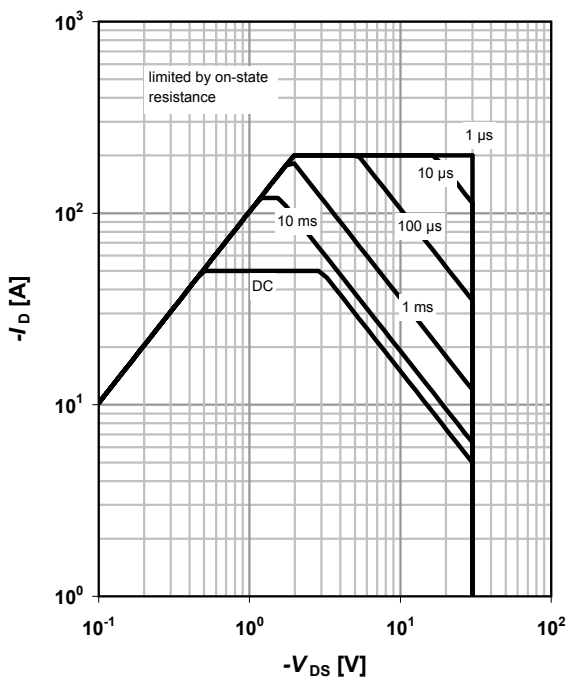

**4 Max. transient thermal impedance**

$$Z_{thJC} = f(t_p)$$

parameter:  $D = t_p / T$

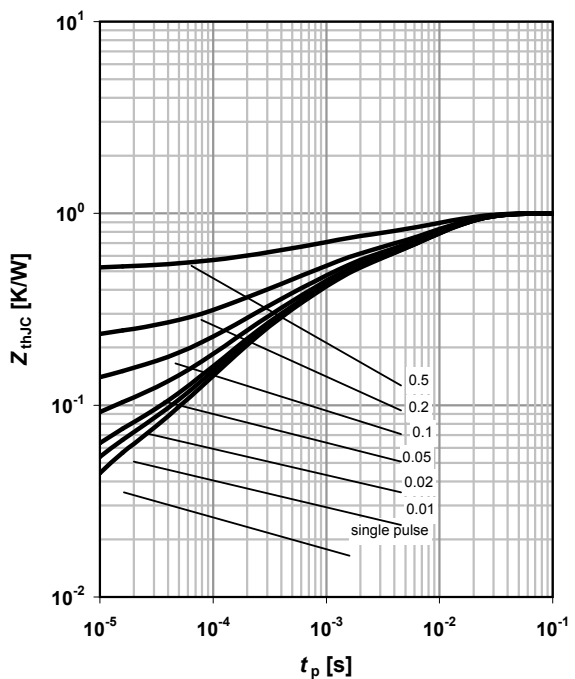

**5 Typ. output characteristics**

$I_D = f(V_{DS}); T_j = 25\text{ }^\circ\text{C}$

parameter:  $V_{GS}$

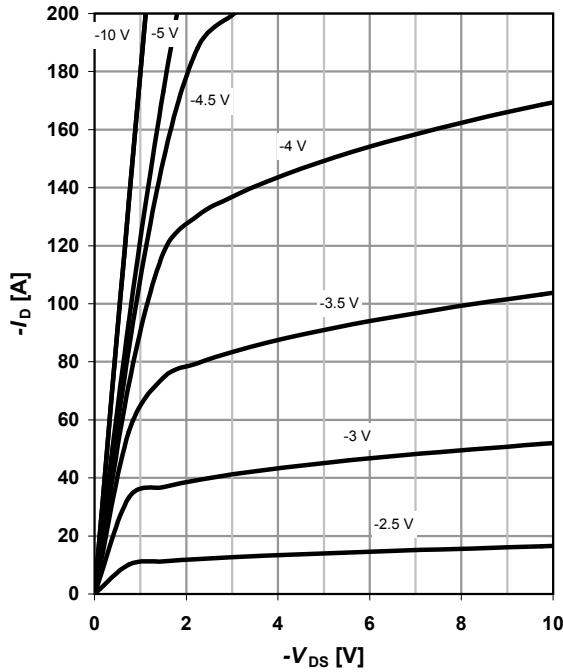

**6 Typ. drain-source on resistance**

$R_{DS(on)} = f(I_D); T_j = 25\text{ }^\circ\text{C}$

parameter:  $V_{GS}$

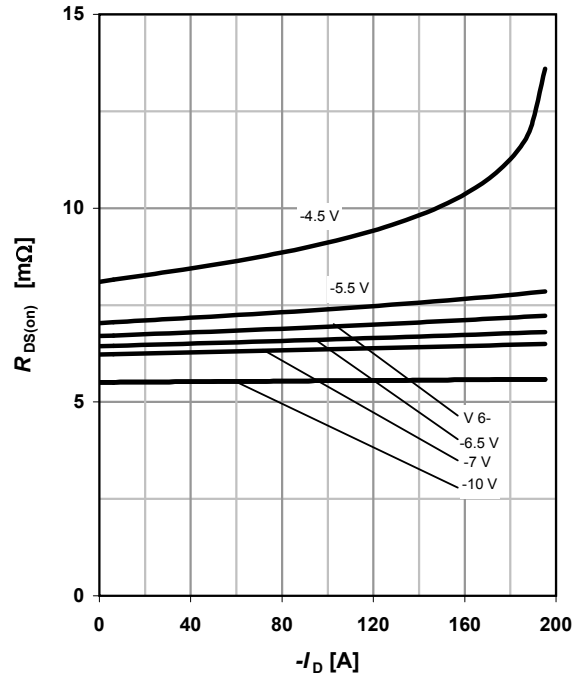

**7 Typ. transfer characteristics**

$I_D = f(V_{GS}); |V_{DS}| > 2|I_D|R_{DS(on)max}$

parameter:  $T_j$

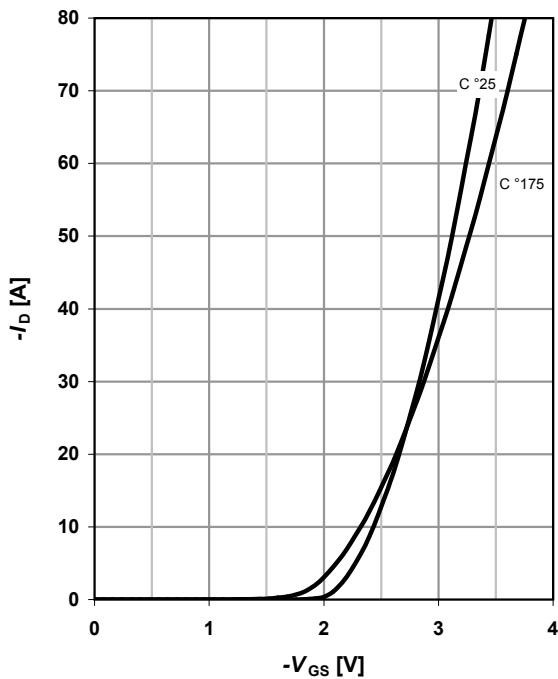

**8 Typ. forward transconductance**

$g_{fs} = f(I_D); T_j = 25\text{ }^\circ\text{C}$

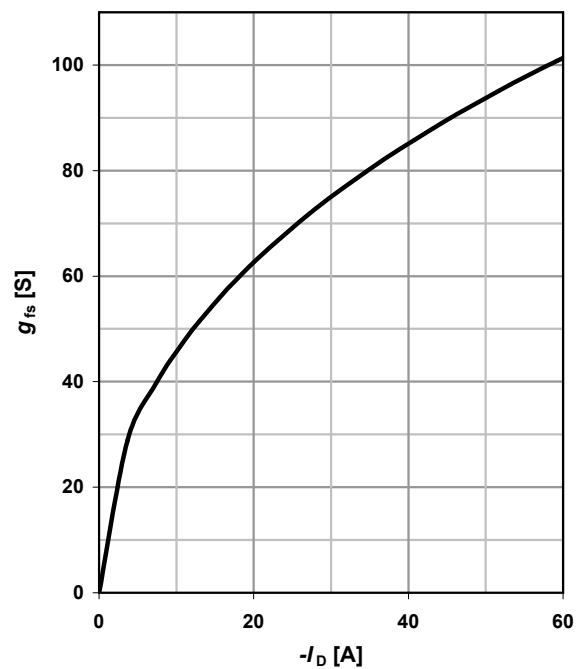

**9 Drain-source on-state resistance**

$R_{DS(on)} = f(T_j); I_D = -50 \text{ A}; V_{GS} = -10 \text{ V}$

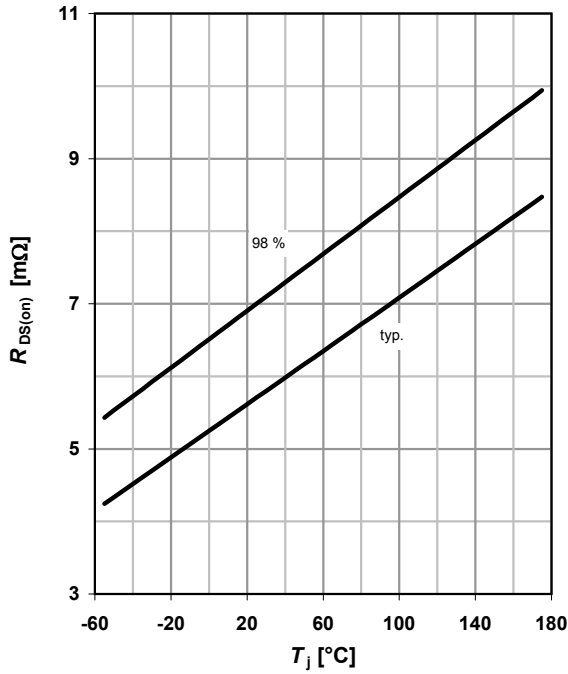

**10 Typ. gate threshold voltage**

$V_{GS(th)} = f(T_j); V_{GS} = V_{DS}; I_D = -250 \mu\text{A}$

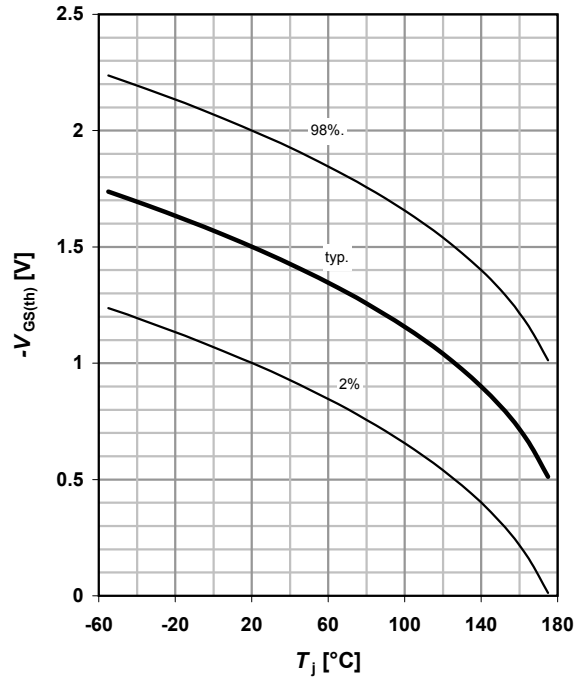

**11 Typ. capacitances**

$C = f(V_{DS}); V_{GS} = 0 \text{ V}; f = 1 \text{ MHz}$

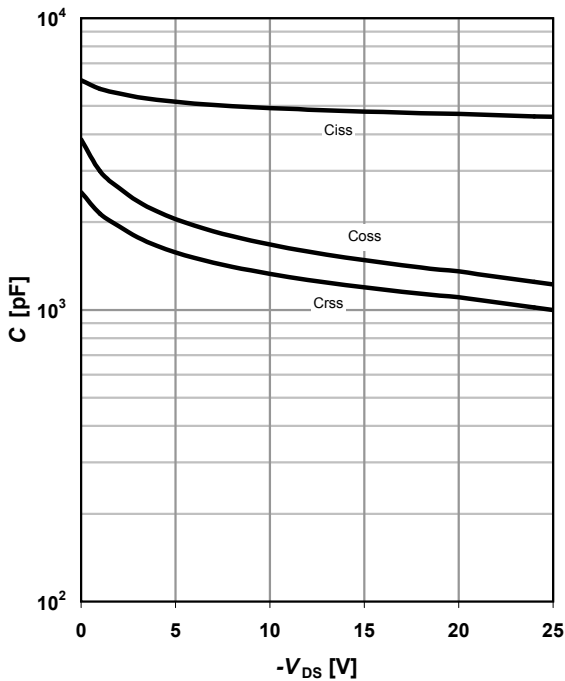

**12 Forward characteristics of reverse diode**

$I_F = f(V_{SD})$

parameter:  $T_j$

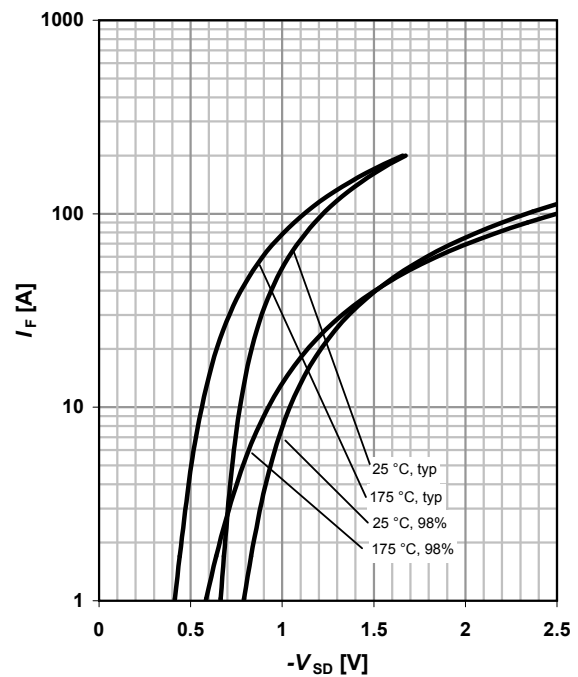

**13 Avalanche characteristics**

$$I_{AS} = f(t_{AV}); R_{GS} = 25 \Omega$$

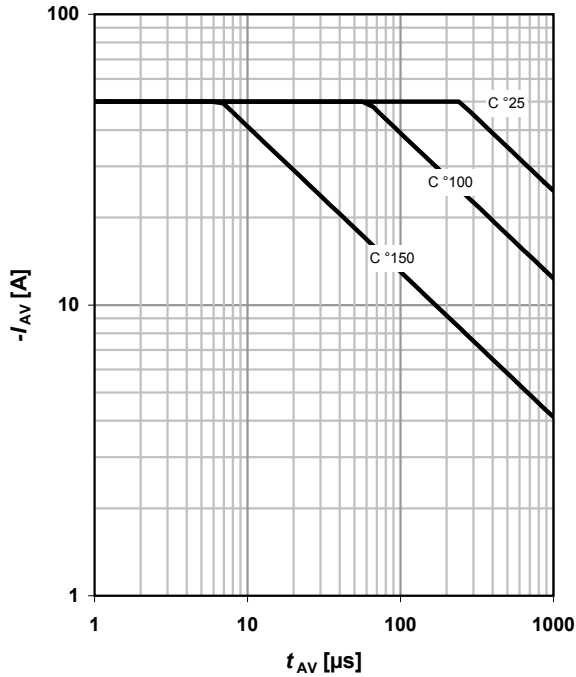
 parameter:  $T_{j(\text{start})}$ 

**14 Typ. gate charge**

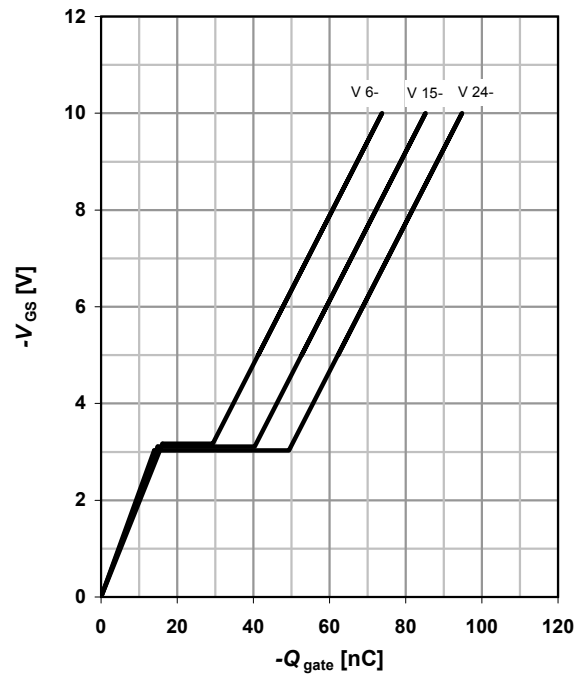
$$V_{GS} = f(Q_{\text{gate}}); I_D = -50 \text{ A pulsed}$$

 parameter:  $V_{DD}$ 

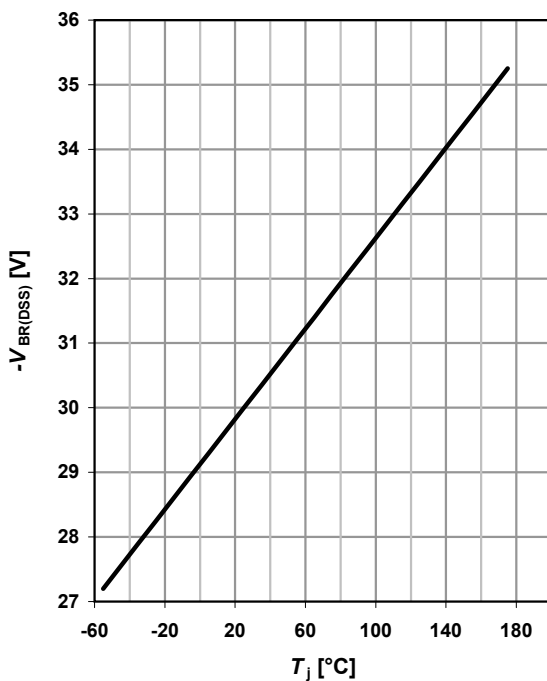
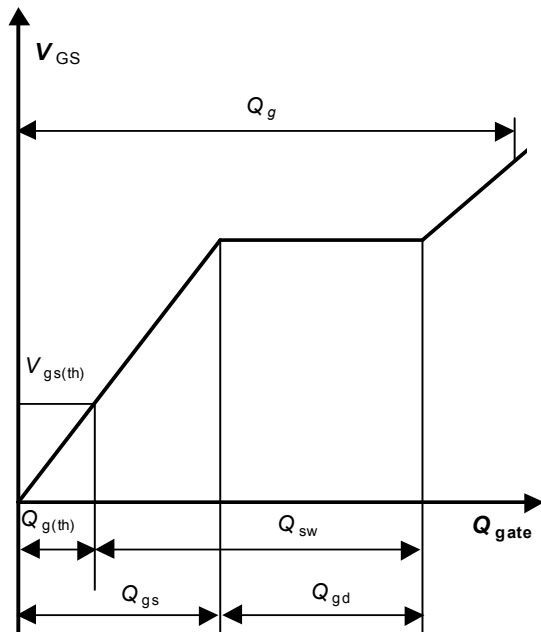
**15 Drain-source breakdown voltage**

$$V_{BR(DSS)} = f(T_j); I_D = -250 \mu\text{A}$$

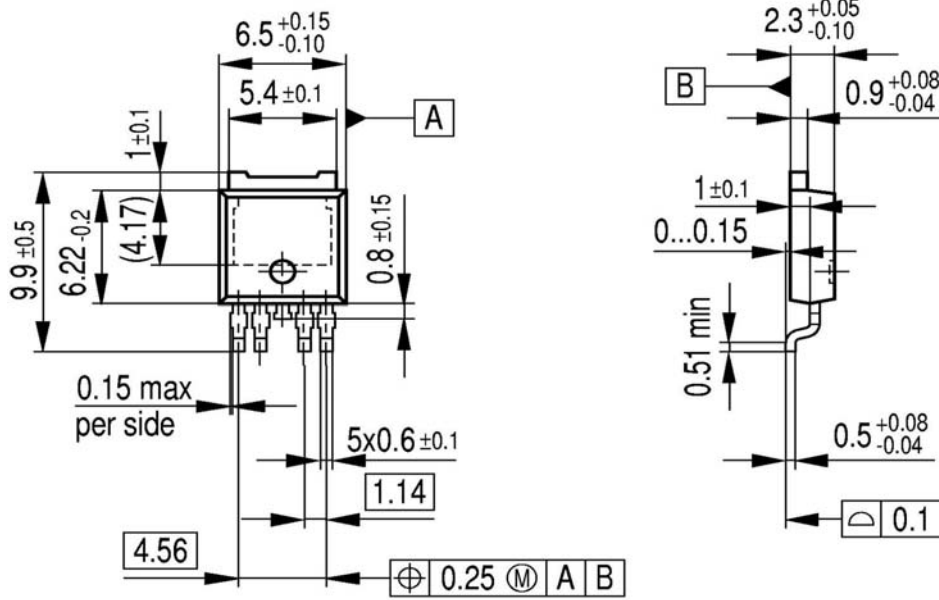

**16 Gate charge waveforms**

Package Outline

PG-TO252-5: Outline

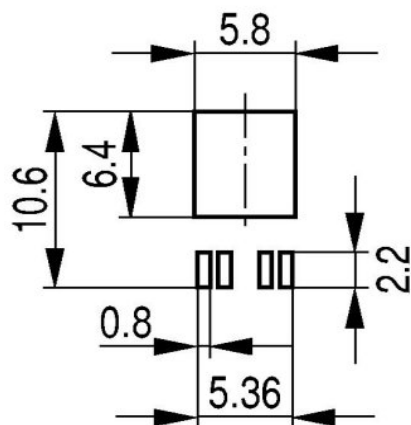

Footprint



Packaging Tape

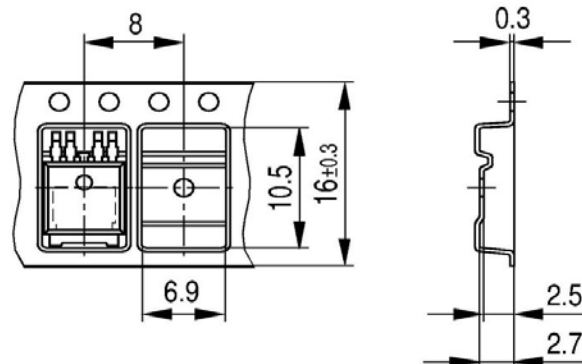

Dimensions in mm



**Published by**  
**Infineon Technologies AG**  
**81726 Munich, Germany**  
**© 2008 Infineon Technologies AG**  
**All Rights Reserved.**

**Legal Disclaimer**

The information given in this document shall in no event be regarded as a guarantee of conditions or characteristics. With respect to any examples or hints given herein, any typical values stated herein and/or any information regarding the application of the device, Infineon Technologies hereby disclaims any and all warranties and liabilities of any kind, including without limitation, warranties of non-infringement of intellectual property rights of any third party.

**Information**

For further information on technology, delivery terms and conditions and prices, please contact the nearest Infineon Technologies Office ([www.infineon.com](http://www.infineon.com)).

**Warnings**

Due to technical requirements, components may contain dangerous substances. For information on the types in question, please contact the nearest Infineon Technologies Office. Infineon Technologies components may be used in life-support devices or systems only with the express written approval of Infineon Technologies, if a failure of such components can reasonably be expected to cause the failure of that life-support device or system or to affect the safety or effectiveness of that device or system. Life support devices or systems are intended to be implanted in the human body or to support and/or maintain and sustain and/or protect human life. If they fail, it is reasonable to assume that the health of the user or other persons may be endangered.

# Mouser Electronics

Authorized Distributor

Click to View Pricing, Inventory, Delivery & Lifecycle Information:

[Infineon:](#)

[SPD50P03LGBTMA1](#) [SPD50P03LGXT](#)