

Features

- 0.39 inch digit height.
- Low current operation.
- Excellent character appearance.
- Easy mounting on P.C. boards or sockets.
- Mechanically rugged.
- Standard : gray face, white segment.
- RoHS compliant.

Description

The Super Bright Red source color devices are made with Gallium Aluminum Arsenide Red Light Emitting Diode.

Package Dimensions & Internal Circuit Diagram

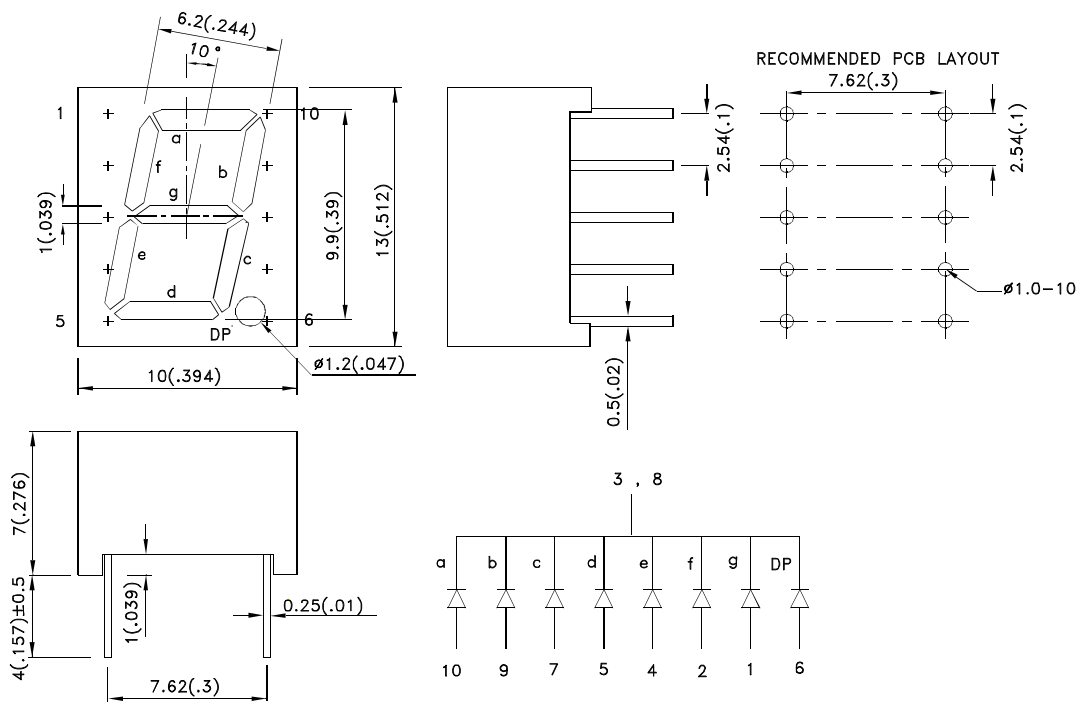

Notes:

1. All dimensions are in millimeters (inches), Tolerance is $\pm 0.25(0.01)$ unless otherwise noted.
2. The specifications, characteristics and technical data described in the datasheet are subject to change without prior notice.



Selection Guide

| Part No. | Dice | Lens Type | Iv (ucd) [1] @ 10mA | | Description |
|-------------|---------------------------|----------------|------------------------|-------|-----------------------------------|
| | | | Min. | Typ. | |
| SC39-11SRWA | Super Bright Red (GaAlAs) | White Diffused | 9000 | 17000 | Common Cathode, Rt. Hand Decimal. |

Note:

1. Luminous intensity/ luminous Flux: +/-15%.

Electrical / Optical Characteristics at TA=25°C

| Symbol | Parameter | Device | Typ. | Max. | Units | Test Conditions |
|-----------------------|--------------------------|------------------|------|------|-------|---------------------------|
| λ_{peak} | Peak Wavelength | Super Bright Red | 660 | | nm | I _F =20mA |
| λ_D [1] | Dominant Wavelength | Super Bright Red | 640 | | nm | I _F =20mA |
| $\Delta\lambda_{1/2}$ | Spectral Line Half-width | Super Bright Red | 20 | | nm | I _F =20mA |
| C | Capacitance | Super Bright Red | 45 | | pF | V _F =0V;f=1MHz |
| V _F [2] | Forward Voltage | Super Bright Red | 1.85 | 2.5 | V | I _F =20mA |
| I _R | Reverse Current | Super Bright Red | | 10 | uA | V _R =5V |

Notes:

1. Wavelength: +/-1nm.

2. Forward Voltage: +/-0.1V.

Absolute Maximum Ratings at TA=25°C

| Parameter | Super Bright Red | Units |
|---------------------------------|-----------------------|-------|
| Power dissipation | 75 | mW |
| DC Forward Current | 30 | mA |
| Peak Forward Current [1] | 155 | mA |
| Reverse Voltage | 5 | V |
| Operating / Storage Temperature | -40°C To +85°C | |
| Lead Solder Temperature[2] | 260°C For 3-5 Seconds | |

Notes:

1. 1/10 Duty Cycle, 0.1ms Pulse Width.

2. 2mm below package base.

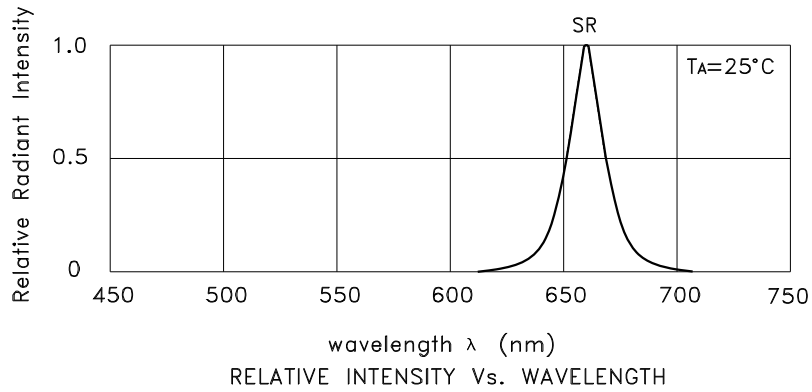

Super Bright Red

SC39-11SRWA

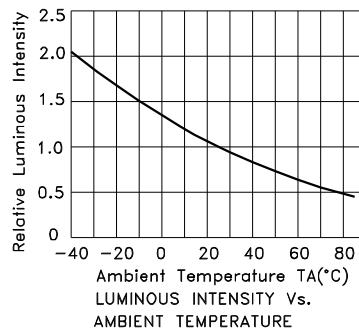
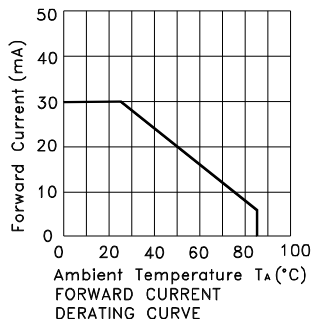
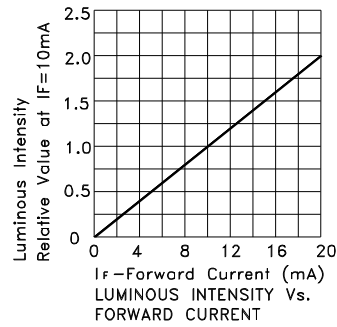
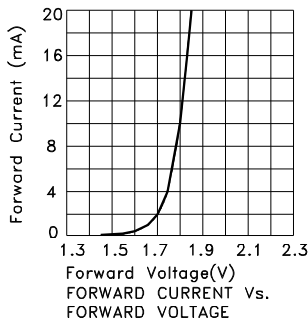

PACKING & LABEL SPECIFICATIONS

SC39-11SRWA

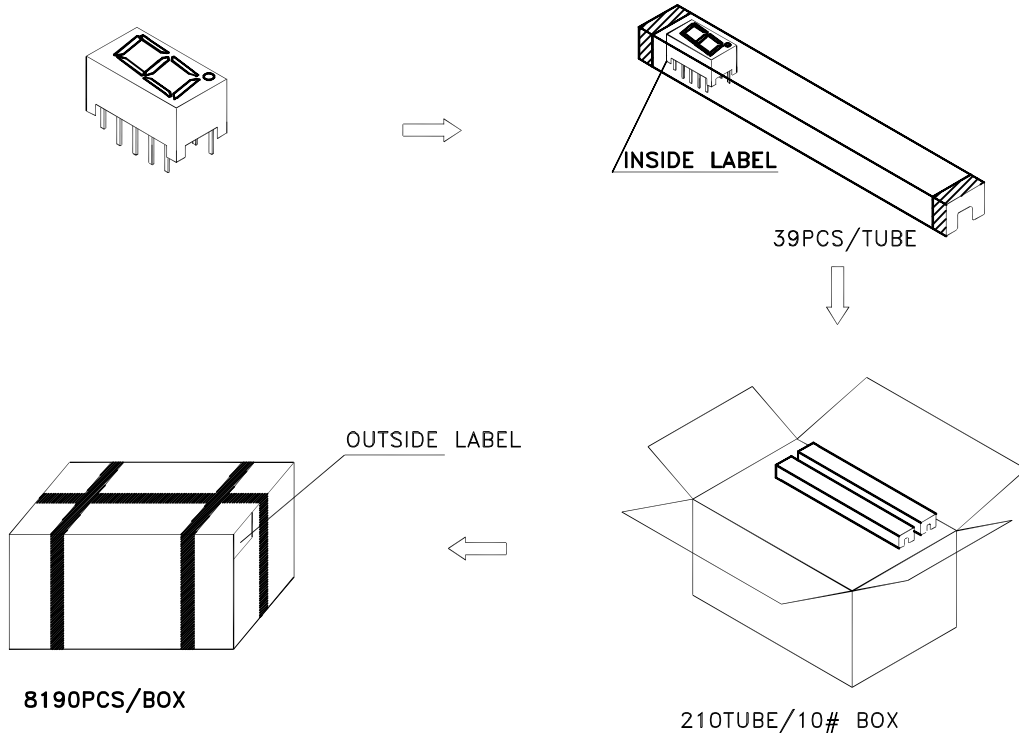

Inside Label On IC-tube

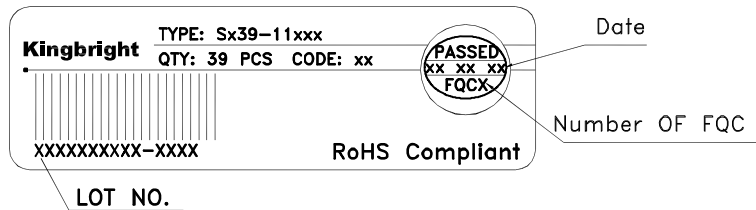

Outside Label On Box

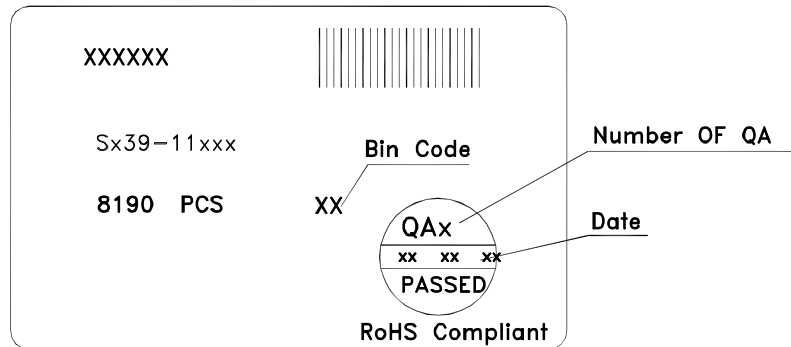

THROUGH HOLE DISPLAY MOUNTING METHOD

Lead Forming

Do not bend the component leads by hand without proper tools.
The leads should be bent by clinching the upper part of the lead firmly such that the bending force is not exerted on the plastic body.

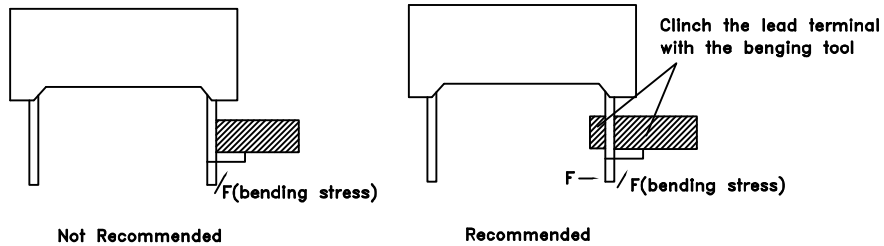

Installation

- 1.The installation process should not apply stress to the lead terminals.
- 2.When inserting for assembly, ensure the terminal pitch matches the substrate board's hole pitch to prevent spreading or pinching the lead terminals.

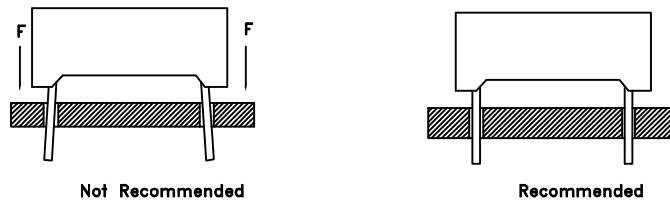

DISPLAY SOLDERING CONDITIONS

Wave Soldering Profile For Lead-free Through-hole LED.

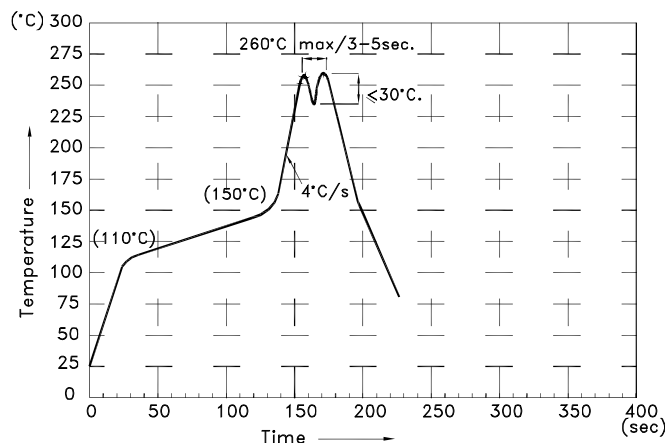

NOTES:

- 1.Recommend the wave temperature 245°C~260°C.The maximum soldering temperature should be less than 260°C.
- 2.Do not apply stress on epoxy resins when temperature is over 85°C.
- 3.The soldering profile apply to the lead free soldering (Sn/Cu/Ag alloy).
- 4.During wave soldering , the PCB top-surface temperature should be kept below 105°C
- 5.No more than once.

Soldering General Notes:

- a. Through-hole displays are incompatible with reflow soldering.
- b. If components will undergo multiple soldering processes, or other processes where the components may be subjected to intense heat, please check with Kingbright for compatibility.

CLEANING

1. Mild "no-clean" fluxes are recommended for use in soldering.
2. If cleaning is required, Kingbright recommends to wash components with water only. Do not use harsh organic solvents for cleaning, because they may damage the plastic parts. And the devices should not be washed for more than one minute.

CIRCUIT DESIGN NOTES

1. Protective current-limiting resistors may be necessary to operate the Displays.
2. LEDs mounted in parallel should each be placed in series with its own current-limiting resistor.

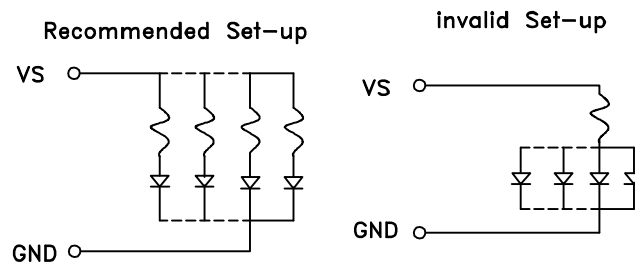

Mouser Electronics

Authorized Distributor

Click to View Pricing, Inventory, Delivery & Lifecycle Information:

[Kingbright:](#)

[SC39-11SRWA](#)