

RO3112C

433.420 MHz SAW Resonator

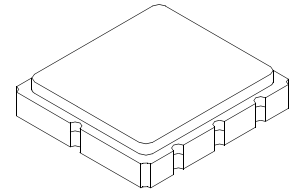

SM5050-8 Case
5 X 5

- Ideal for European 433.420 MHz Remote Control and Security Transmitters
- Very Low Series Resistance
- Quartz Stability
- Complies with Directive 2002/95/EC (RoHS)



The RO3112C is a true one-port, surface-acoustic-wave (SAW) resonator in a surface-mount ceramic case. It provides reliable, fundamental-mode, quartz frequency stabilization of fixed-frequency transmitters operating at 433.42 MHz. This SAW is designed specifically for use in remote control and wireless security transmitters operating in Europe under ETSI I-ETS 300 220.

Absolute Maximum Ratings

Rating	Value	Units
Input Power Level	0	dBm
DC Voltage	12	VDC
Storage Temperature	-40 to +85	°C
Soldering Temperature (10 seconds / 5 cycles maximum)	260	°C

Electrical Characteristics

Characteristic		Sym	Notes	Minimum	Typical	Maximum	Units
Center Frequency +25 °C	Absolute Frequency	f_C	2,3,4,5	433.345		433.495	MHz
	Tolerance from 433.420 MHz	Δf_C					
Insertion Loss		IL	2,5,6		1.2	1.5	dB
Quality Factor	Unloaded Q	Q_U			8700		
	50Ω Loaded Q	Q_L			920		
Temperature Stability	Turnover Temperature	T_O	6,7,8	10	25	40	°C
	Turnover Frequency	f_O					
	Frequency Temperature Coefficient	FTC					
Frequency Aging	Absolute Value during the First Year	$ f_A $	1		≤ 10		ppm/yr
DC Insulation Resistance between Any Two Terminals			5	1.0			MΩ
RF Equivalent RLC Model	Motional Resistance	R_M	5, 7, 9		11.9		Ω
	Motional Inductance	L_M			37.9		μH
	Motional Capacitance	C_M			3.6		fF
	Shunt Static Capacitance	C_O			3.8		pF
Test Fixture Shunt Inductance		L_{TEST}	2, 7		35.4		nH
Lid Symbolization (in addition to Lot and/or Date Codes)		657 // YWWS					
Standard Reel Quantity	Reel Size 7 Inch		500 Pieces/Reel				
	Reel Size 13 Inch		3000 Pieces/Reel				

 **CAUTION: Electrostatic Sensitive Device. Observe precautions for handling.**

NOTES:

- Frequency aging is the change in f_C with time and is specified at +65 °C or less. Aging may exceed the specification for prolonged temperatures above +65 °C. Typically, aging is greatest the first year after manufacture, decreasing in subsequent years.
- The center frequency, f_C , is measured at the minimum insertion loss point, IL_{MIN} , with the resonator in the 50 Ω test system (VSWR $\leq 1.2:1$). The shunt inductance, L_{TEST} , is tuned for parallel resonance with C_O at f_C . Typically, $f_{OSCILLATOR}$ or $f_{TRANSMITTER}$ is approximately equal to the resonator f_C .
- One or more of the following United States patents apply: 4,454,488 and 4,616,197.
- Typically, equipment utilizing this device requires emissions testing and government approval, which is the responsibility of the equipment manufacturer.
- Unless noted otherwise, case temperature $T_C = +25 \pm 2$ °C.
- The design, manufacturing process, and specifications of this device are subject to change without notice.
- Derived mathematically from one or more of the following directly measured parameters: f_C , IL, 3 dB bandwidth, f_C versus T_C , and C_O .
- Turnover temperature, T_O , is the temperature of maximum (or turnover) frequency, f_O . The nominal frequency at any case temperature, T_C , may be calculated from: $f = f_O [1 - FTC (T_O - T_C)^2]$. Typically *oscillator* T_O is approximately equal to the specified *resonator* T_O .
- This equivalent RLC model approximates resonator performance near the resonant frequency and is provided for reference only. The capacitance C_O is the static (nonmotional) capacitance between the two terminals measured at low frequency (10 MHz) with a capacitance meter. The measurement includes parasitic capacitance with "NC" pads unconnected. Case parasitic capacitance is approximately 0.05 pF. Transducer parallel capacitance can be calculated as: $C_P \approx C_O - 0.05$ pF.

Electrical Connections

The SAW resonator is bidirectional and may be installed with either orientation. The two terminals are interchangeable and unnumbered. The callout NC indicates no internal connection. The NC pads assist with mechanical positioning and stability. External grounding of the NC pads is recommended to help reduce parasitic capacitance in the circuit.

Pin	Connection
1	NC
2	Terminal
3	NC
4	NC
5	NC
6	Terminal
7	NC
8	NC

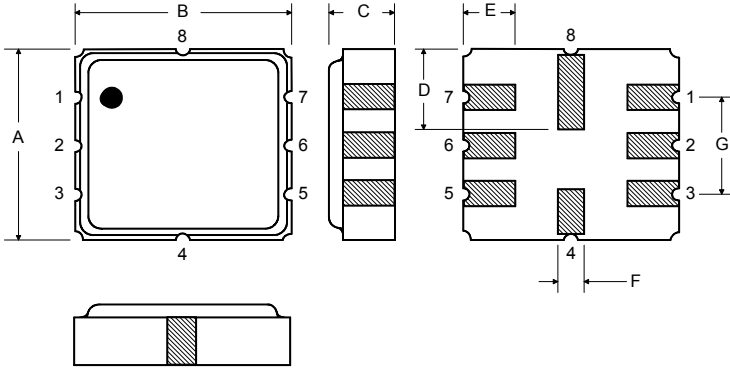

Dimension	mm			Inches		
	Min	Nom	Max	Min	Nom	Max
A	4.80	5.00	5.20	0.189	0.197	0.205
B	4.80	5.00	5.20	0.189	0.197	0.205
C	1.30	1.50	1.70	0.050	0.060	0.067
D	1.98	2.08	2.18	0.078	0.082	0.086
E	1.07	1.17	1.27	0.042	0.046	0.050
F	0.50	0.64	0.70	0.020	0.025	0.028
G	2.39	2.54	2.69	0.094	0.100	0.106
H		1.27			0.050	
I		0.76			0.030	
J		1.55			0.061	
K		2.79			0.110	
L		0.76			0.030	
M		2.36			0.093	
N		1.55			0.061	
O		2.79			0.110	
P		2.79			0.110	
Q		2.79			0.110	

Parameter Test Circuit

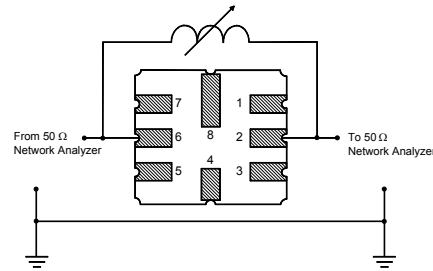

Power Test Circuit

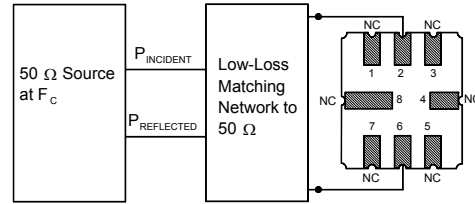

Example Application Circuits

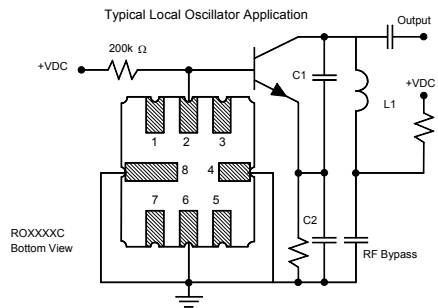
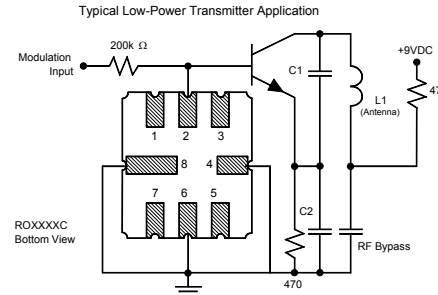

Equivalent RLC Model

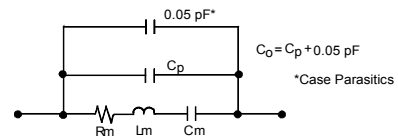

Temperature Characteristics

The curve shown on the right accounts for resonator contribution only and does not include LC component temperature contributions.

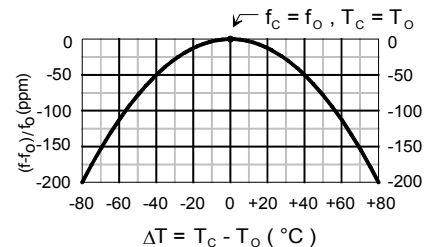

Mouser Electronics

Authorized Distributor

Click to View Pricing, Inventory, Delivery & Lifecycle Information:

[Murata:](#)

[RO3112C](#)