

Schottky Barrier Rectifier

DO-201AD
FEATURES

- Guardring for overvoltage protection
- Extremely fast switching
- Low forward voltage drop
- High forward surge capability
- High frequency operation
- Solder dip 275 °C max. 10 s, per JESD 22-B106
- Compliant to RoHS directive 2002/95/EC and in accordance to WEEE 2002/96/EC

RoHS
COMPLIANT

TYPICAL APPLICATIONS

For use in low voltage high frequency inverters, freewheeling, dc-to-dc converters, and polarity protection applications.

MECHANICAL DATA
Case: DO-201AD

Molding compound meets UL 94 V-0 flammability rating
Base P/N-E3 - RoHS compliant, commercial grade

Terminals: Matte tin plated leads, solderable per J-STD-002 and JESD 22-B102

E3 suffix meets JESD 201 class 1A whisker test

Polarity: Color band denotes the cathode end

PRIMARY CHARACTERISTICS	
$I_{F(AV)}$	5.0 A
V_{RRM}	20 V to 60 V
I_{FSM}	220 A
V_F	0.48 V, 0.65 V
T_J max.	150 °C

MAXIMUM RATINGS ($T_A = 25\text{ °C}$ unless otherwise noted)							
PARAMETER	SYMBOL	SB520	SB530	SB540	SB550	SB560	UNIT
Maximum repetitive peak reverse voltage	V_{RRM}	20	30	40	50	60	V
Maximum RMS voltage	V_{RMS}	14	21	28	35	42	V
Maximum DC blocking voltage	V_{DC}	20	30	40	50	60	V
Maximum average forward rectified current at 0.375" (9.5 mm) lead length (fig. 1)	$I_{F(AV)}$	5.0					A
Peak forward surge current, 8.3 ms single half sine-wave superimposed on rated load	I_{FSM}	220					A
Operating junction temperature range	T_J	- 65 to + 150					°C
Storage temperature range	T_{STG}	- 65 to + 150					°C

ELECTRICAL CHARACTERISTICS ($T_A = 25\text{ °C}$ unless otherwise noted)								
PARAMETER	TEST CONDITIONS	SYMBOL	SB520	SB530	SB540	SB550	SB560	UNIT
Maximum instantaneous forward voltage	5.0 A	$V_F^{(1)}$	0.48			0.65		V
Maximum instantaneous reverse current at rated DC blocking voltage	$T_A = 25\text{ °C}$	$I_R^{(1)}$	0.5					mA
	$T_A = 100\text{ °C}$		50		25			

Note

(1) Pulse test: 300 μ s pulse width, 1 % duty cycle

THERMAL CHARACTERISTICS ($T_A = 25\text{ }^\circ\text{C}$ unless otherwise noted)

PARAMETER	SYMBOL	SB520	SB530	SB540	SB550	SB560	UNIT
Typical thermal resistance	$R_{\theta JA}^{(1)}$			25			$^\circ\text{C/W}$
	$R_{\theta JL}^{(1)}$			8			

Note

(1) Thermal resistance from junction to lead vertical P.C.B. mounting, 0.375" (9.5 mm) lead length

ORDERING INFORMATION (Example)

PREFERRED P/N	UNIT WEIGHT (g)	PREFERRED PACKAGE CODE	BASE QUANTITY	DELIVERY MODE
SB540-E3/54	1.09	54	1400	13" diameter paper tape and reel
SB540-E3/73	1.09	73	1000	Ammo pack packaging

RATINGS AND CHARACTERISTICS CURVES

($T_A = 25\text{ }^\circ\text{C}$ unless otherwise noted)

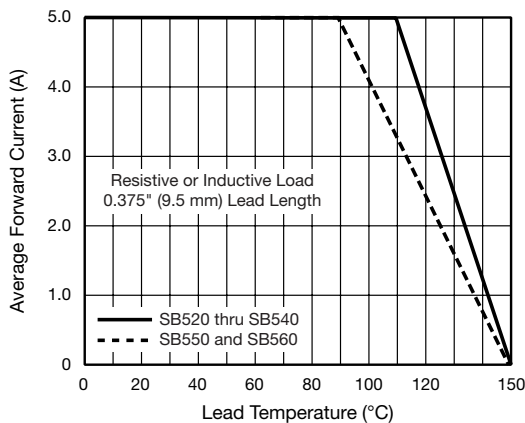

Fig. 1 - Forward Current Derating Curve

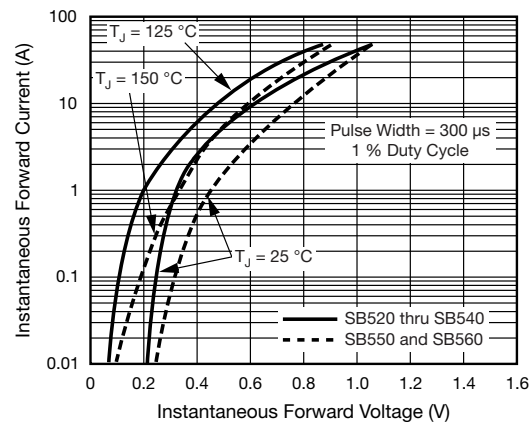

Fig. 3 - Typical Instantaneous Forward Characteristics

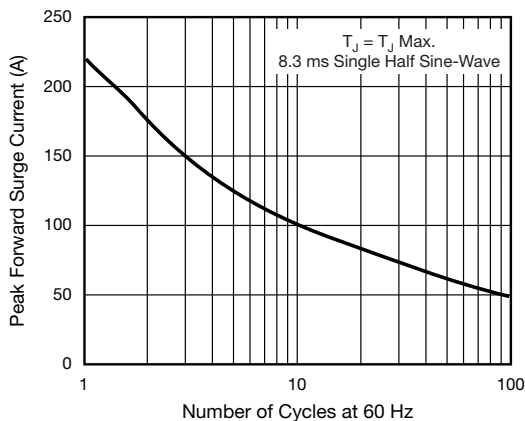

Fig. 2 - Maximum Non-Repetitive Peak Forward Surge Current

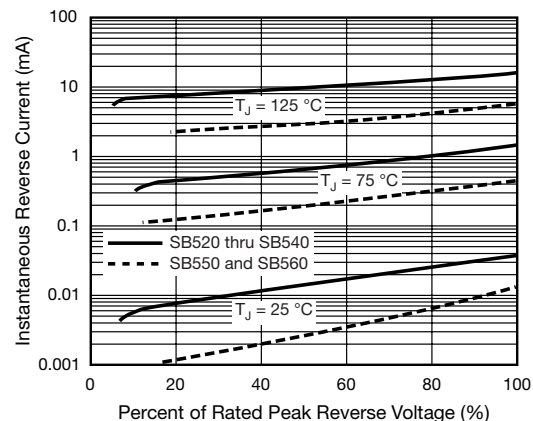

Fig. 4 - Typical Reverse Characteristics

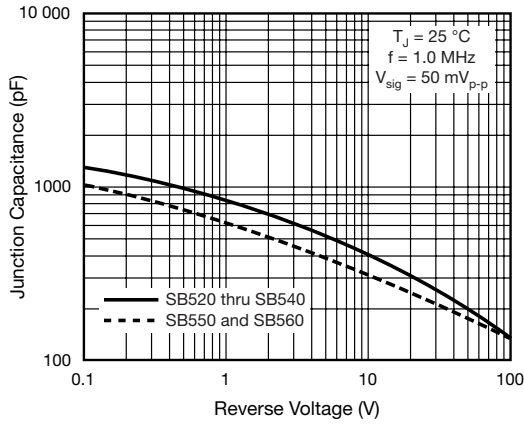

Fig. 5 - Typical Junction Capacitance

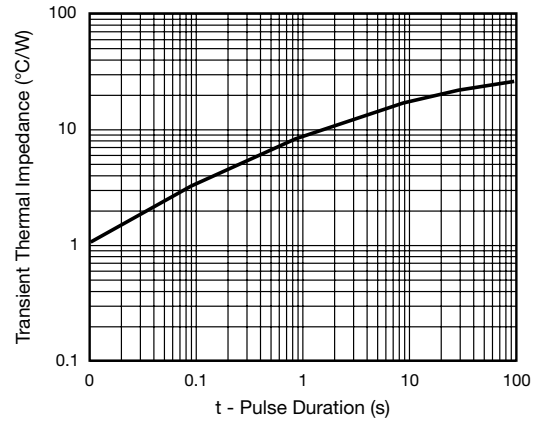
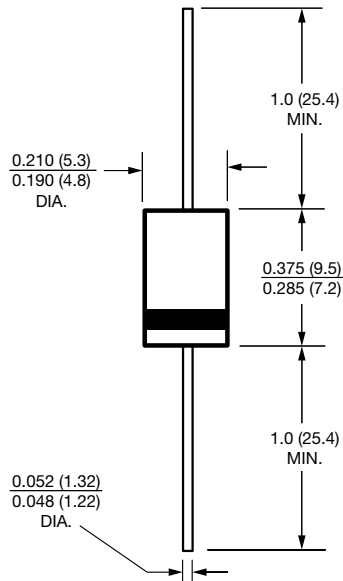

Fig. 6 - Typical Transient Thermal Impedance

PACKAGE OUTLINE DIMENSIONS in inches (millimeters)

DO-201AD





Disclaimer

ALL PRODUCT, PRODUCT SPECIFICATIONS AND DATA ARE SUBJECT TO CHANGE WITHOUT NOTICE TO IMPROVE RELIABILITY, FUNCTION OR DESIGN OR OTHERWISE.

Vishay Intertechnology, Inc., its affiliates, agents, and employees, and all persons acting on its or their behalf (collectively, "Vishay"), disclaim any and all liability for any errors, inaccuracies or incompleteness contained in any datasheet or in any other disclosure relating to any product.

Vishay makes no warranty, representation or guarantee regarding the suitability of the products for any particular purpose or the continuing production of any product. To the maximum extent permitted by applicable law, Vishay disclaims (i) any and all liability arising out of the application or use of any product, (ii) any and all liability, including without limitation special, consequential or incidental damages, and (iii) any and all implied warranties, including warranties of fitness for particular purpose, non-infringement and merchantability.

Statements regarding the suitability of products for certain types of applications are based on Vishay's knowledge of typical requirements that are often placed on Vishay products in generic applications. Such statements are not binding statements about the suitability of products for a particular application. It is the customer's responsibility to validate that a particular product with the properties described in the product specification is suitable for use in a particular application. Parameters provided in datasheets and / or specifications may vary in different applications and performance may vary over time. All operating parameters, including typical parameters, must be validated for each customer application by the customer's technical experts. Product specifications do not expand or otherwise modify Vishay's terms and conditions of purchase, including but not limited to the warranty expressed therein.

Except as expressly indicated in writing, Vishay products are not designed for use in medical, life-saving, or life-sustaining applications or for any other application in which the failure of the Vishay product could result in personal injury or death. Customers using or selling Vishay products not expressly indicated for use in such applications do so at their own risk. Please contact authorized Vishay personnel to obtain written terms and conditions regarding products designed for such applications.

No license, express or implied, by estoppel or otherwise, to any intellectual property rights is granted by this document or by any conduct of Vishay. Product names and markings noted herein may be trademarks of their respective owners.

Mouser Electronics

Authorized Distributor

Click to View Pricing, Inventory, Delivery & Lifecycle Information:

[Vishay:](#)

[SB520A-E3/54](#) [SB520A-E3/73](#) [SB520-E3/51](#) [SB520-E3/54](#) [SB520-E3/73](#) [SB530-E3/51](#) [SB530-E3/54](#) [SB530-E3/73](#) [SB540A-E3/51](#) [SB540A-E3/54](#) [SB540-E3/51](#) [SB540-E3/54](#) [SB540-E3/73](#) [SB550A-E3/51](#) [SB550A-E3/54](#) [SB550-E3/51](#) [SB550-E3/54](#) [SB550-E3/73](#) [SB560A-E3/51](#) [SB560A-E3/54](#) [SB560A-E3/73](#) [SB560-E3/51](#) [SB560-E3/54](#) [SB560-E3/73](#) [SB520/54](#) [SB520A/54](#) [SB520A/73](#) [SB520-E3/23](#) [SB530/1](#) [SB530/23](#) [SB530/4](#) [SB530/54](#) [SB540/1](#) [SB540/23](#) [SB540/4](#) [SB540/51](#) [SB540/54](#) [SB540A/54](#) [SB540A-E3/73](#) [SB540-E3/1](#) [SB540-E3/23](#) [SB550/23](#) [SB550/54](#) [SB560/1](#) [SB560/23](#) [SB560/4](#) [SB560/51](#) [SB560/54](#) [SB560A/23](#) [SB560A/54](#) [SB560A-E3/1](#) [SB560A-E3/23](#) [SB560-E3/1](#) [SB560-E3/23](#) [SB560-E3/4](#) [SB550A-E3/73](#)