Ultrafast Soft Recovery Dual Rectifier Diode
PRODUCT APPLICATIONS

- Anti-Parallel Diode
 - Switchmode Power Supply
 - Inverters
- Free Wheeling Diode
 - Motor Controllers
 - Converters
- Snubber Diode
- Uninterruptible Power Supply
- Induction Heating
- High Speed Rectifiers

PRODUCT FEATURES

- Ultrafast Recovery Times (t_{rr})
- Soft Recovery Characteristics
- Low Forward Voltage
- Low Forward Voltage
- High Blocking Voltage
- Low Leakage Current

PRODUCT BENEFITS

- Low Losses
- Low Noise Switching
- Cooler Operation
- Higher Reliability Systems
- Increased System Power Density

MAXIMUM RATINGS

 All Ratings per Diode: $T_C = 25^\circ\text{C}$ unless otherwise specified.

Symbol	Characteristic / Test Conditions	Ratings	Unit
V_R	Maximum D.C. Reverse Voltage	600	Volts
V_{RRM}	Maximum Peak Repetitive Reverse Voltage		
V_{RWM}	Maximum Working Peak Reverse Voltage		
$I_{F(AV)}$	Maximum Average Forward current ($T_C = 40^\circ\text{C}$, Duty Cycle = 0.5)	150	Amps
$I_{F(RMS)}$	RMS Forward Current (Square wave, 50% duty)	165	
I_{FSM}	Non-Repetitive Forward Surge Current ($T_J = 45^\circ\text{C}$, 8.3 ms)	1000	
T_J, T_{STG}	Operating and Storage Junction Temperature Range	-55 to 175	°C

STATIC ELECTRICAL CHARACTERISTICS

Symbol	Characteristic / Test Conditions	Min	Typ	Max	Unit	
V_F	Forward Voltage		$I_F = 150\text{A}$	1.25	1.6	Volts
			$I_F = 300\text{A}$	2.0		
			$I_F = 150\text{A}, T_J = 125^\circ\text{C}$	1.25		
I_{RM}	Maximum Reverse Leakage Current		$V_R = 600\text{V}$		25	μA
			$V_R = 600\text{V}, T_J = 125^\circ\text{C}$		250	
C_T	Junction Capacitance, $V_R = 200\text{V}$		139		pF	

1 Continuous current limited by package lead temperature.

DYNAMIC CHARACTERISTICS

APT2X151_150DL60J

Symbol	Characteristic / Test Conditions	Min	Typ	Max	Unit
t_{rr}	Reverse Recovery Time $I_F = 1A, di_F/dt = -15A/\mu s, V_R = 30V, T_J = 25^\circ C$		51		ns
t_{rr}	Reverse Recovery Time		408		
Q_{rr}	Reverse Recovery Charge		2387		nC
I_{RRM}	Maximum Reverse Recovery Current		13		
t_{rr}	Reverse Recovery Time		639		ns
Q_{rr}	Reverse Recovery Charge		7253		
I_{RRM}	Maximum Reverse Recovery Current		21		Amps
t_{rr}	Reverse Recovery Time		299		ns
Q_{rr}	Reverse Recovery Charge		12075		
I_{RRM}	Maximum Reverse Recovery Current		68		Amps

THERMAL AND MECHANICAL CHARACTERISTICS

Symbol	Characteristic / Test Conditions	Min	Typ	Max	Unit
$R_{\theta JC}$	Junction-to-Case Thermal Resistance			0.56	$^\circ C/W$
$V_{Isolation}$	RMS Voltage (50-60mHz Sinusoidal Waveform from Terminals to Mounting Base for 1 Min.)	2500			
W_T	Package Weight		1.03		oz
			29.2		g
Torque	Maximum Mounting Torque			10	lb-in
				1.1	N-m

Microsemi reserves the right to change, without notice, the specifications and information contained herein.

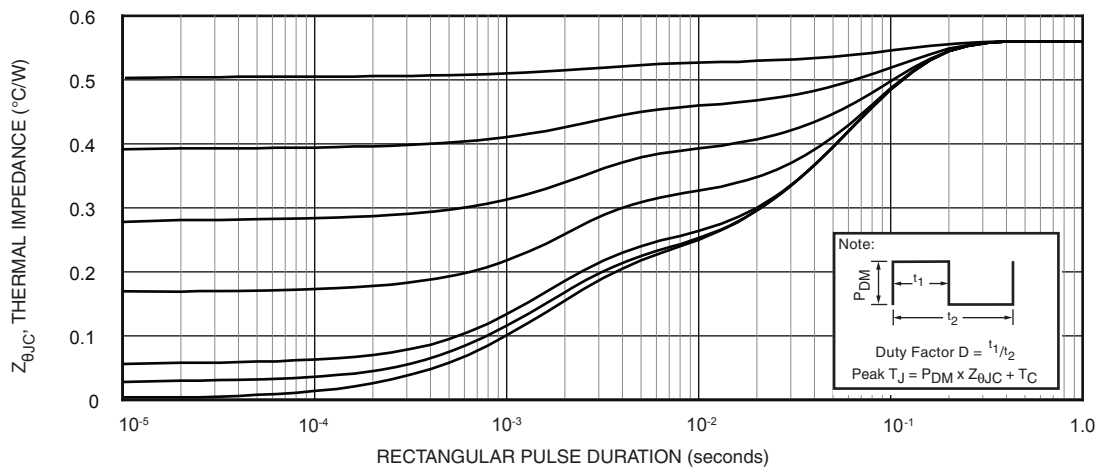

FIGURE 1. MAXIMUM EFFECTIVE TRANSIENT THERMAL IMPEDANCE, JUNCTION-TO-CASE vs. PULSE DURATION

TYPICAL PERFORMANCE CURVES

APT2X151_150DL60J

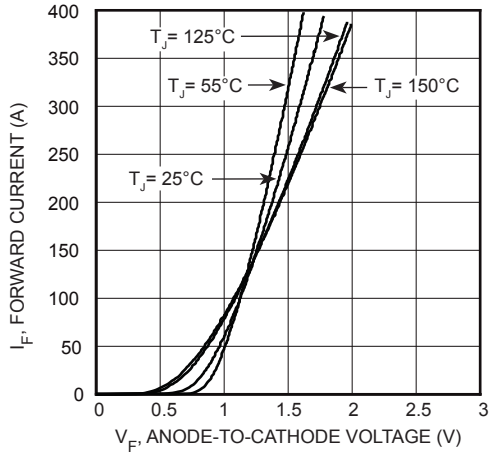

FIGURE 2, Forward Current vs. Forward Voltage

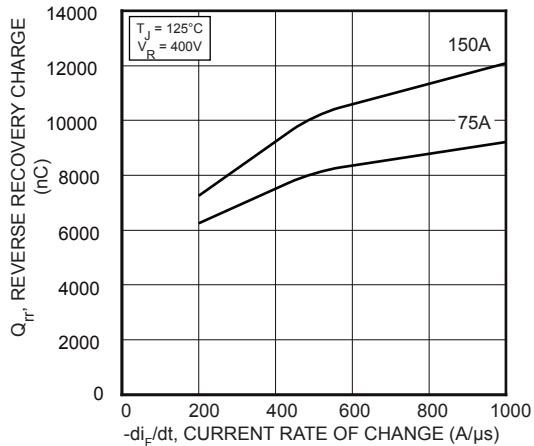

FIGURE 4, Reverse Recovery Charge vs. Current Rate of Change

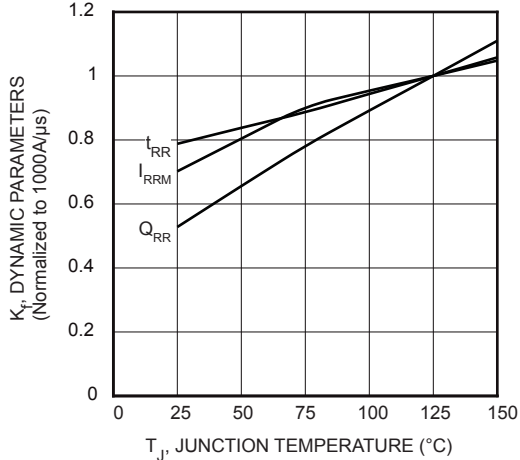

FIGURE 6, Dynamic Parameters vs. Junction Temperature

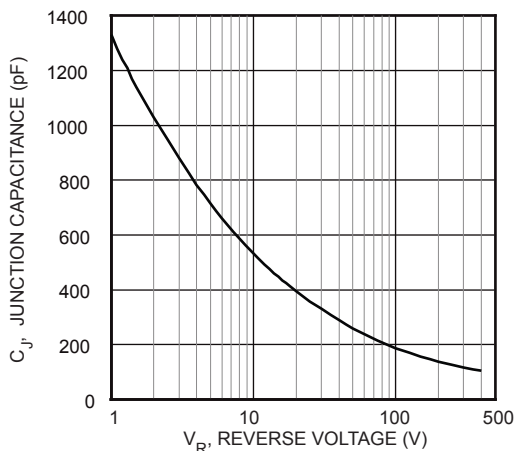

FIGURE 8, Junction Capacitance vs. Reverse Voltage

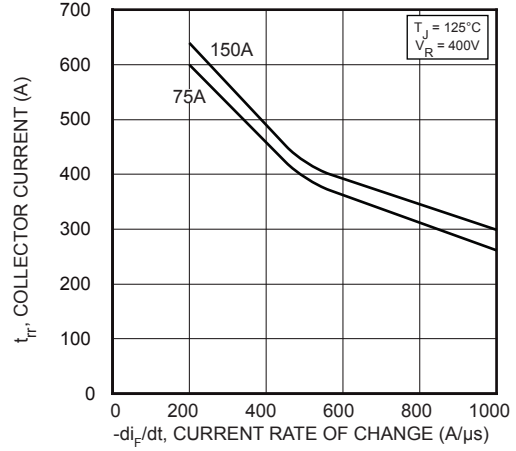

FIGURE 3, Reverse Recovery Time vs. Current Rate of Change

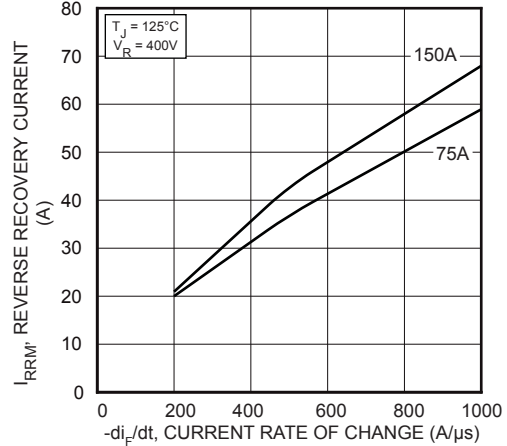

FIGURE 5, Reverse Recovery Current vs. Current Rate of Change

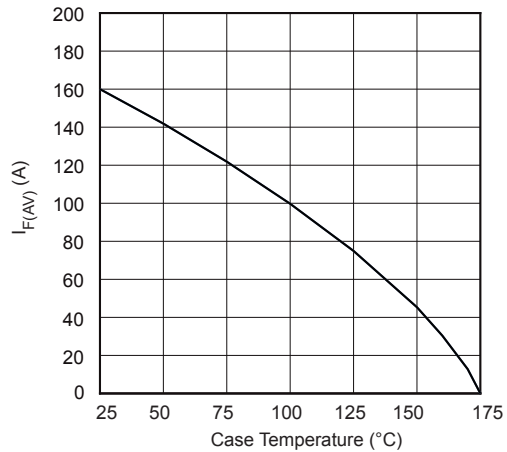

FIGURE 7, Maximum Average Forward Current vs. Case Temperature

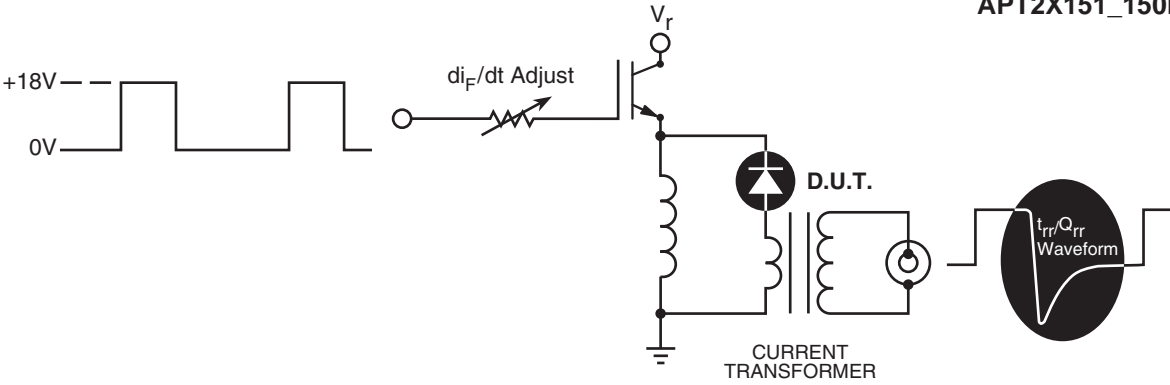

Figure 9. Diode Test Circuit

- 1 I_F - Forward Conduction Current
- 2 di_F/dt - Rate of Diode Current Change Through Zero Crossing.
- 3 I_{RRM} - Maximum Reverse Recovery Current.
- 4 t_{rr} - Reverse Recovery Time, measured from zero crossing where diode current goes from positive to negative, to the point at which the straight line through I_{RRM} and $0.25 \cdot I_{RRM}$ passes through zero.
- 5 Q_{rr} - Area Under the Curve Defined by I_{RRM} and t_{rr} .
- 6 di_M/dt - Maximum Rate of Current Increase During the Trailing Portion of t_{rr} .

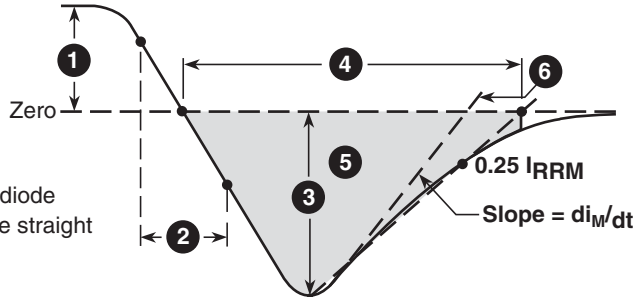
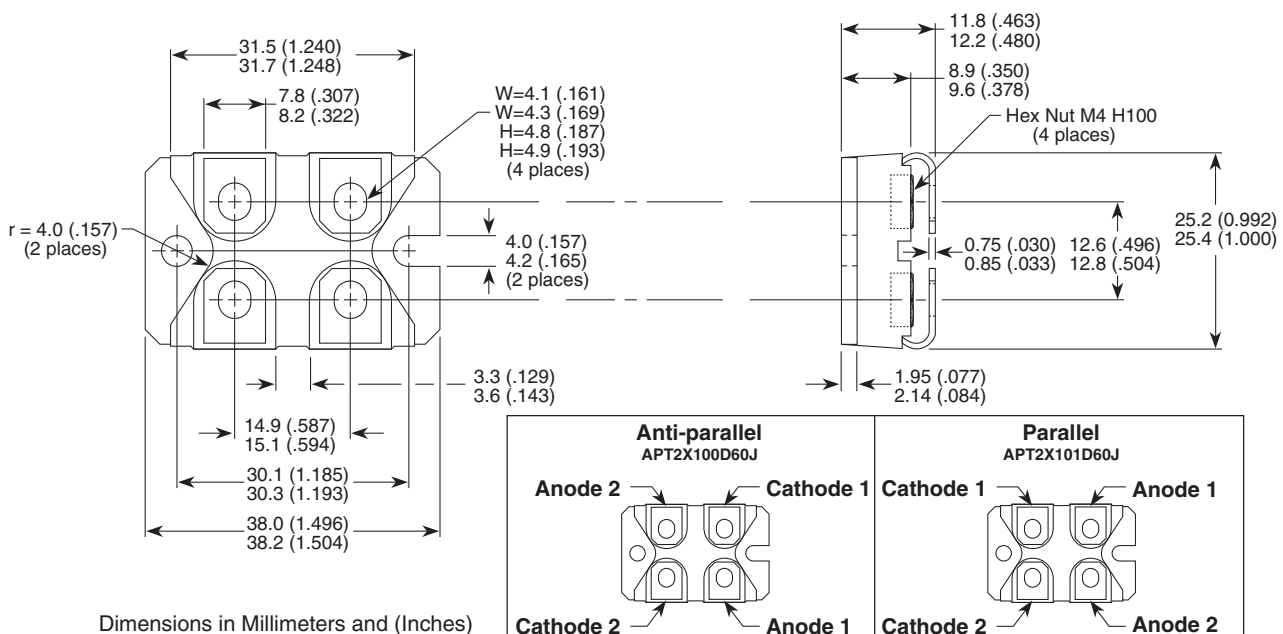

Figure 10, Diode Reverse Recovery Waveform and Definitions

SOT-227 (ISOTOP®) Package Outline



Mouser Electronics

Authorized Distributor

Click to View Pricing, Inventory, Delivery & Lifecycle Information:

[Microsemi:](#)

[APT2X151DL60J](#)