

HiPerFRED²

$$V_{RRM} = 400V$$

$$I_{FAV} = 2 \times 15A$$

$$t_{rr} = 45ns$$

High Performance Fast Recovery Diode
 Low Loss and Soft Recovery
 Common Cathode

Part number

DPG30C400HB

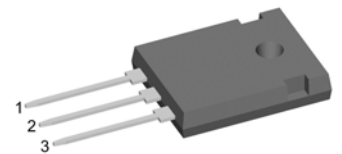

Backside: cathode

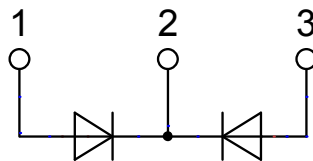
**Features / Advantages:**

- Planar passivated chips
- Very low leakage current
- Very short recovery time
- Improved thermal behaviour
- Very low I_{rm} -values
- Very soft recovery behaviour
- Avalanche voltage rated for reliable operation
- Soft reverse recovery for low EMI/RFI
- Low I_{rm} reduces:
 - Power dissipation within the diode
 - Turn-on loss in the commutating switch

Applications:

- Antiparallel diode for high frequency switching devices
- Antisaturation diode
- Snubber diode
- Free wheeling diode
- Rectifiers in switch mode power supplies (SMPS)
- Uninterruptible power supplies (UPS)

Package: TO-247

- Industry standard outline
- RoHS compliant
- Epoxy meets UL 94V-0

Fast Diode				Ratings		
Symbol	Definition	Conditions	min.	typ.	max.	Unit
V_{RSM}	max. non-repetitive reverse blocking voltage	$T_{VJ} = 25^{\circ}\text{C}$			400	V
V_{RRM}	max. repetitive reverse blocking voltage	$T_{VJ} = 25^{\circ}\text{C}$			400	V
I_R	reverse current, drain current	$V_R = 400\text{ V}$	$T_{VJ} = 25^{\circ}\text{C}$		1	μA
		$V_R = 400\text{ V}$	$T_{VJ} = 150^{\circ}\text{C}$		0.18	mA
V_F	forward voltage drop	$I_F = 15\text{ A}$	$T_{VJ} = 25^{\circ}\text{C}$		1.38	V
		$I_F = 30\text{ A}$			1.61	V
		$I_F = 15\text{ A}$	$T_{VJ} = 150^{\circ}\text{C}$		1.13	V
		$I_F = 30\text{ A}$			1.39	V
I_{FAV}	average forward current	$T_C = 140^{\circ}\text{C}$ rectangular $d = 0.5$	$T_{VJ} = 175^{\circ}\text{C}$		15	A
V_{FO}	threshold voltage	} for power loss calculation only	$T_{VJ} = 175^{\circ}\text{C}$		0.84	V
r_F	slope resistance				15.9	m Ω
R_{thJC}	thermal resistance junction to case				1.7	K/W
R_{thCH}	thermal resistance case to heatsink			0.25		K/W
P_{tot}	total power dissipation		$T_C = 25^{\circ}\text{C}$		90	W
I_{FSM}	max. forward surge current	$t = 10\text{ ms}; (50\text{ Hz}), \text{ sine}; V_R = 0\text{ V}$	$T_{VJ} = 45^{\circ}\text{C}$		190	A
C_J	junction capacitance	$V_R = 200\text{ V}$ $f = 1\text{ MHz}$	$T_{VJ} = 25^{\circ}\text{C}$		16	pF
I_{RM}	max. reverse recovery current	} $I_F = 15\text{ A}; V_R = 270\text{ V}$ $-di_F/dt = 200\text{ A}/\mu\text{s}$	$T_{VJ} = 25^{\circ}\text{C}$		4	A
t_{rr}	reverse recovery time		$T_{VJ} = 125^{\circ}\text{C}$		5.5	A
			$T_{VJ} = 25^{\circ}\text{C}$		45	ns
			$T_{VJ} = 125^{\circ}\text{C}$		70	ns

Package TO-247			Ratings			
Symbol	Definition	Conditions	min.	typ.	max.	Unit
I_{RMS}	RMS current	per terminal ¹⁾			35	A
T_{VJ}	virtual junction temperature		-55		175	°C
T_{op}	operation temperature		-55		150	°C
T_{stg}	storage temperature		-55		150	°C
Weight				6		g
M_D	mounting torque		0.8		1.2	Nm
F_C	mounting force with clip		20		120	N

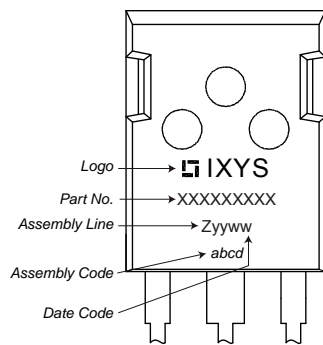
Product Marking

Part number

- D = Diode
- P = HiPerFRED
- G = extreme fast
- 30 = Current Rating [A]
- C = Common Cathode
- 400 = Reverse Voltage [V]
- HB = TO-247AD (3)

Ordering	Part Number	Marking on Product	Delivery Mode	Quantity	Code No.
Standard	DPG30C400HB	DPG30C400HB	Tube	30	505790

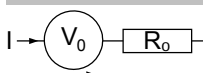
Similar Part	Package	Voltage class
DPG30C400PB	TO-220AB (3)	400

Equivalent Circuits for Simulation
** on die level*
 $T_{VJ} = 175\text{ °C}$

Fast Diode

$V_{0\ max}$	threshold voltage	0.84	V
$R_{0\ max}$	slope resistance *	13.3	mΩ

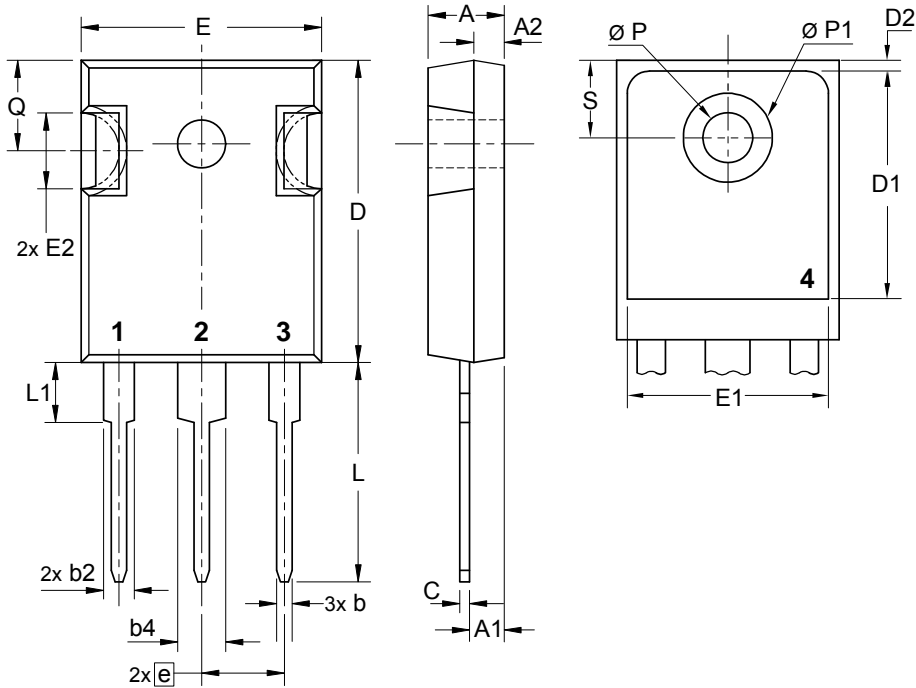
Outlines TO-247

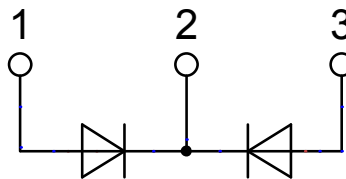

Sym.	Inches		Millimeter	
	min.	max.	min.	max.
A	0.185	0.209	4.70	5.30
A1	0.087	0.102	2.21	2.59
A2	0.059	0.098	1.50	2.49
D	0.819	0.845	20.79	21.45
E	0.610	0.640	15.48	16.24
E2	0.170	0.216	4.31	5.48
e	0.215 BSC		5.46 BSC	
L	0.780	0.800	19.80	20.30
L1	-	0.177	-	4.49
Ø P	0.140	0.144	3.55	3.65
Q	0.212	0.244	5.38	6.19
S	0.242 BSC		6.14 BSC	
b	0.039	0.055	0.99	1.40
b2	0.065	0.094	1.65	2.39
b4	0.102	0.135	2.59	3.43
c	0.015	0.035	0.38	0.89
D1	0.515	-	13.07	-
D2	0.020	0.053	0.51	1.35
E1	0.530	-	13.45	-
Ø P1	-	0.29	-	7.39



Fast Diode

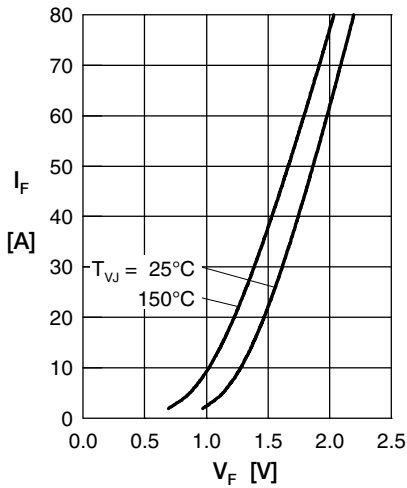

Fig. 1 Forward current I_F versus V_F

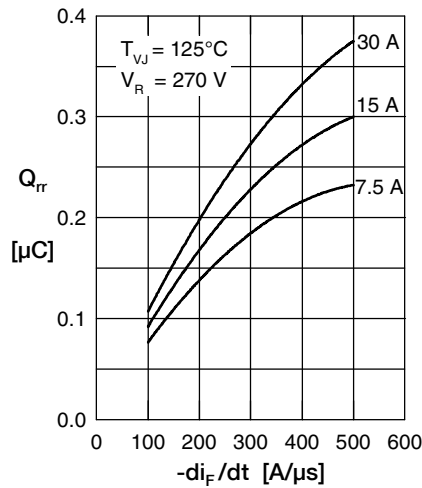

Fig. 2 Typ. reverse recov. charge Q_{rr} versus $-di_F/dt$

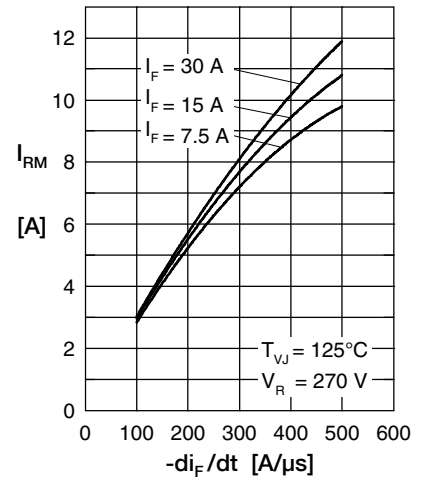

Fig. 3 Typ. peak reverse current I_{RM} versus $-di_F/dt$

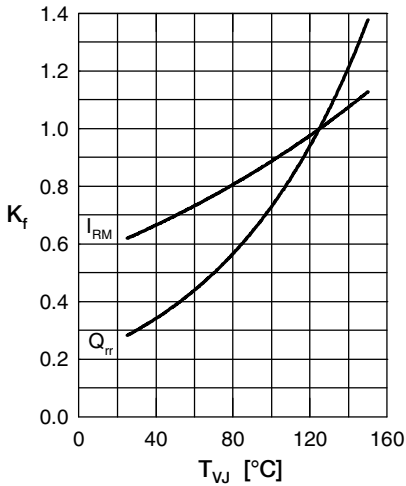

Fig. 4 Typ. dynamic parameters Q_{rr} , I_{RM} versus T_{VJ}

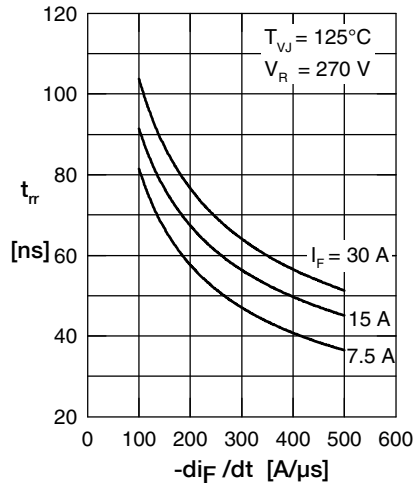

Fig. 5 Typ. recovery time t_{rr} versus $-di_F/dt$

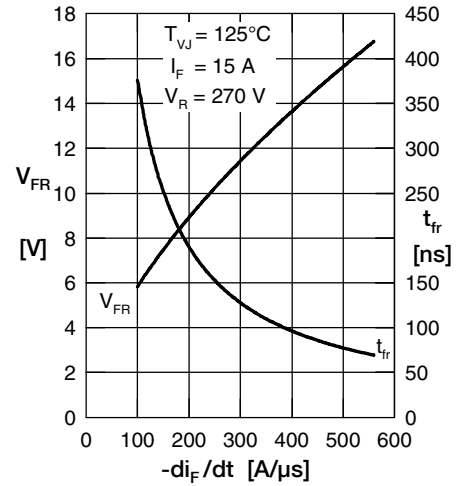

Fig. 6 Typ. peak forward voltage V_{FR} and t_{fr} versus di_F/dt

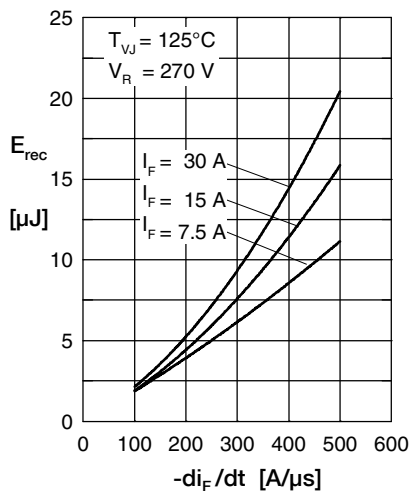

Fig. 7 Typ. recovery energy E_{rec} versus $-di_F/dt$

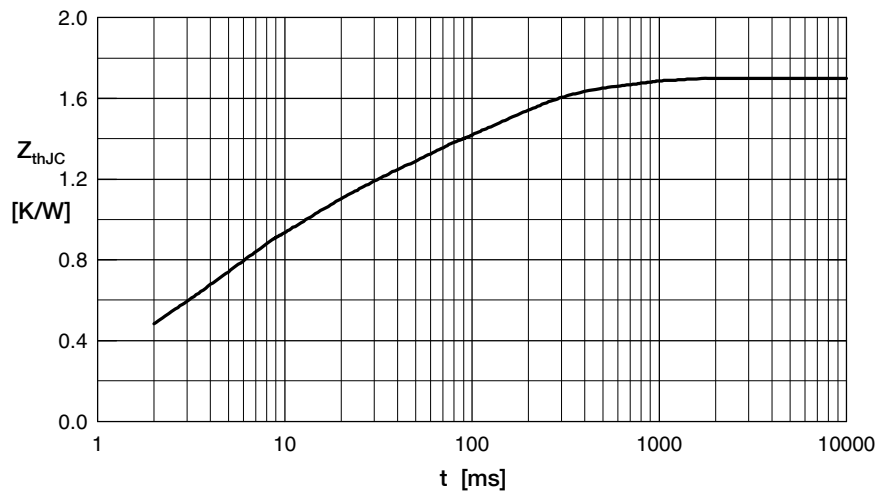

Fig. 8 Transient thermal resistance junction to case

Mouser Electronics

Authorized Distributor

Click to View Pricing, Inventory, Delivery & Lifecycle Information:

[IXYS:](#)

[DPG30C400HB](#)