

TL714C HIGH-SPEED DIFFERENTIAL COMPARATOR

SLCS015A – DECEMBER 1988 – REVISED AUGUST 2003

- Operates From a 5-V Supply
- Self-Biasing Inputs
- Hysteresis . . . 10 mV Typ
- Response Time . . . 6 ns Typ
- Maximum Operating Frequency . . . 50 MHz Typ

D OR P PACKAGE
(TOP VIEW)

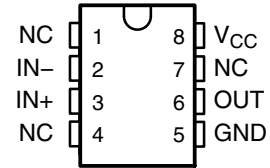

NC – No internal connection

description/ordering information

The TL714C is a high-speed differential comparator fabricated with bipolar Schottky process technology. The circuit has differential inputs and a TTL-compatible logic output with symmetrical switching characteristics.

The device operates from a single 5-V supply and is useful as a disk-memory read-chain data comparator.

ORDERING INFORMATION

T _A	PACKAGE†		ORDERABLE PART NUMBER	TOP-SIDE MARKING
0°C to 70°C	PDIP (P)	Tube of 50	TL714CP	TL714CP
	SOIC (D)	Tube of 75	TL714CD	TL714C
		Reel of 2500	TL714CDR	

† Package drawings, standard packing quantities, thermal data, symbolization, and PCB design guidelines are available at www.ti.com/sc/package.

symbol

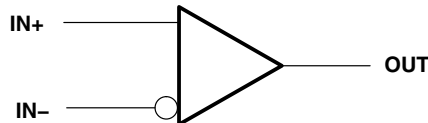

Please be aware that an important notice concerning availability, standard warranty, and use in critical applications of Texas Instruments semiconductor products and disclaimers thereto appears at the end of this data sheet.

PRODUCTION DATA information is current as of publication date. Products conform to specifications per the terms of Texas Instruments standard warranty. Production processing does not necessarily include testing of all parameters.

 **TEXAS
INSTRUMENTS**

POST OFFICE BOX 655303 • DALLAS, TEXAS 75265

Copyright © 2003, Texas Instruments Incorporated

TL714C HIGH-SPEED DIFFERENTIAL COMPARATOR

SLCS015A – DECEMBER 1988 – REVISED AUGUST 2003

schematic of inputs and outputs

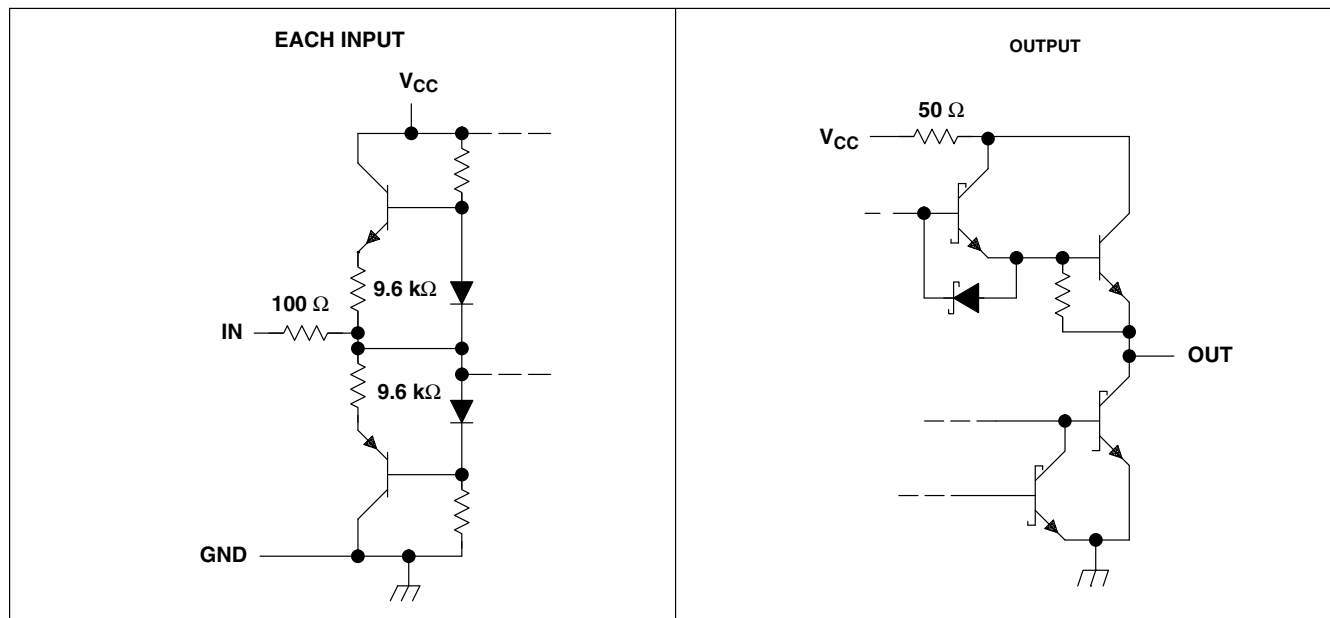

All resistor values shown are nominal.

absolute maximum ratings over operating free-air temperature range (unless otherwise noted)†

Supply voltage, V_{CC} (see Note 1)	7 V
Differential input voltage, V_{ID} (see Note 2)	± 5 V
Input voltage range, V_I	V_{CC} to GND
Low-level output current, I_{OL}	40 mA
Package thermal impedance, θ_{JA} (see Notes 3 and 4):	
D package	97°C/W
P package	85°C/W
Operating virtual junction temperature, T_J	150°C
Lead temperature 1,6 mm (1/16 inch) from case for 10 seconds	260°C
Storage temperature range, T_{stg}	-65°C to 150°C

† Stresses beyond those listed under “absolute maximum ratings” may cause permanent damage to the device. These are stress ratings only, and functional operation of the device at these or any other conditions beyond those indicated under “recommended operating conditions” is not implied. Exposure to absolute-maximum-rated conditions for extended periods may affect device reliability.

- NOTES:
1. All voltage values, except differential voltage, are with respect to the network ground.
 2. Differential voltage values are at IN+ with respect to IN-.
 3. Maximum power dissipation is a function of $T_J(\max)$, θ_{JA} , and T_A . The maximum allowable power dissipation at any allowable ambient temperature is $P_D = (T_J(\max) - T_A) / \theta_{JA}$. Operating at the absolute maximum T_J of 150°C can affect reliability.
 4. The package thermal impedance is calculated in accordance with JESD 51-7.

recommended operating conditions

		MIN	MAX	UNIT
V_{CC}	Supply voltage	4.75	5.25	V
V_{IC}	Common-mode input voltage	1.4 to $V_{CC}-1.4$		V
I_{OH}	High-level output current		-1	mA
I_{OL}	Low-level output current		16	mA
T_A	Operating free-air temperature	0	70	°C



POST OFFICE BOX 655303 • DALLAS, TEXAS 75265

TL714C HIGH-SPEED DIFFERENTIAL COMPARATOR

SLCS015A – DECEMBER 1988 – REVISED AUGUST 2003

electrical characteristics over free-air operating temperature range, $V_{CC} = 5\text{ V}$ (unless otherwise noted)

PARAMETER		TEST CONDITIONS	MIN	TYP†	MAX	UNIT
V_T	Threshold voltage (V_{T+} and V_{T-})	$V_{IC} = 1.4\text{ V to } 3.6\text{ V}$	-75‡		75	mV
V_{hys}	Hysteresis ($V_{T+} - V_{T-}$)		2	10	30	mV
V_{OH}	High-level output voltage	$V_{ID} = 100\text{ mV}, I_{OH} = -1\text{ mA}$	2.7	3.4		V
V_{OL}	Low-level output voltage	$V_{ID} = -100\text{ mV}, I_{OL} = 16\text{ mA}$		0.4	0.5	V
I_{OS}	Short-circuit output current		-30		-110	mA
r_i	Differential input resistance		2.9			k Ω
I_{CC}	Supply current	$V_{ID} = -100\text{ mV}, I_O = 0$		7	12	mA

† All typical values are at $T_A = 25^\circ\text{C}$.

‡ The algebraic convention, where the more-negative limit is designated as minimum, is used in this data sheet for input threshold voltage levels only.

switching characteristics, $V_{CC} = 5\text{ V}, T_A = 25^\circ\text{C}$

PARAMETER		TEST CONDITIONS	MIN	TYP†	MAX	UNIT
f_{max}	Maximum operating frequency	$V_{ID} = \pm 250\text{ mV},$ $C_L = 25\text{ pF},$ $t_r = t_f = 4\text{ ns},$ Input duty cycle = 50%		50		MHz
t_{PLH}	Propagation delay time, low-to-high-level output	$V_{ID} = \pm 100\text{ mV},$ $C_L = 25\text{ pF},$ See Figures 1 and 2		6	12	ns
t_{PHL}	Propagation delay time, high-to-low-level output	See Figures 1 and 2		6	12	ns
t_r	Rise time	$V_{ID} = \pm 100\text{ mV},$ $C_L = 25\text{ pF},$		4	8	ns
t_f	Fall time	See Figure 3		4	8	ns

† All typical values are at $T_A = 25^\circ\text{C}$.

PARAMETER MEASUREMENT INFORMATION

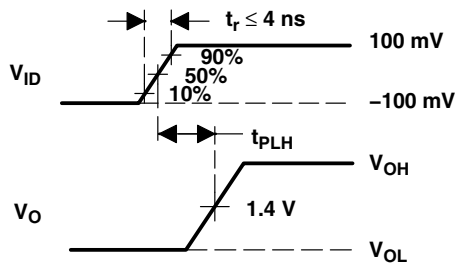

Figure 1. Propagation Delay Time, Low to High (t_{PLH})

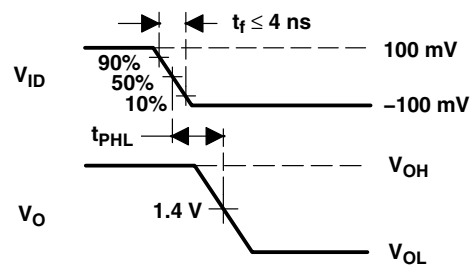

Figure 2. Propagation Delay Time, High to Low (t_{PHL})

TL714C HIGH-SPEED DIFFERENTIAL COMPARATOR

SLCS015A – DECEMBER 1988 – REVISED AUGUST 2003

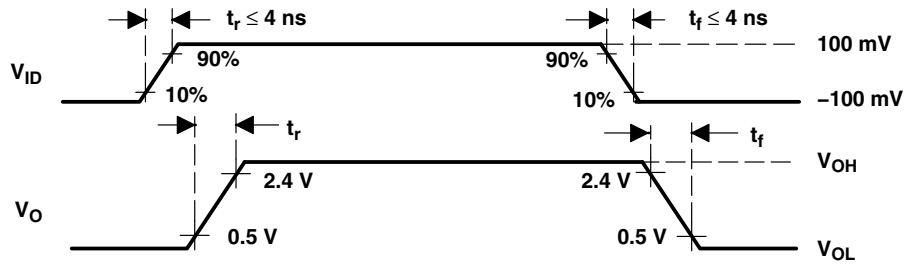

Figure 3. Rise and Fall Times (t_r , t_f)

PACKAGING INFORMATION

Orderable Device	Status (1)	Package Type	Package Drawing	Pins	Package Qty	Eco Plan (2)	Lead/Ball Finish (6)	MSL Peak Temp (3)	Op Temp (°C)	Device Marking (4/5)	Samples
TL714CD	ACTIVE	SOIC	D	8	75	Green (RoHS & no Sb/Br)	NIPDAU	Level-1-260C-UNLIM	0 to 70	TL714C	Samples
TL714CDR	ACTIVE	SOIC	D	8	2500	Green (RoHS & no Sb/Br)	NIPDAU	Level-1-260C-UNLIM	0 to 70	TL714C	Samples
TL714CP	ACTIVE	PDIP	P	8	50	Green (RoHS & no Sb/Br)	NIPDAU	N / A for Pkg Type	0 to 70	TL714CP	Samples

(1) The marketing status values are defined as follows:

ACTIVE: Product device recommended for new designs.

LIFEBUY: TI has announced that the device will be discontinued, and a lifetime-buy period is in effect.

NRND: Not recommended for new designs. Device is in production to support existing customers, but TI does not recommend using this part in a new design.

PREVIEW: Device has been announced but is not in production. Samples may or may not be available.

OBsolete: TI has discontinued the production of the device.

(2) **RoHS:** TI defines "RoHS" to mean semiconductor products that are compliant with the current EU RoHS requirements for all 10 RoHS substances, including the requirement that RoHS substance do not exceed 0.1% by weight in homogeneous materials. Where designed to be soldered at high temperatures, "RoHS" products are suitable for use in specified lead-free processes. TI may reference these types of products as "Pb-Free".

RoHS Exempt: TI defines "RoHS Exempt" to mean products that contain lead but are compliant with EU RoHS pursuant to a specific EU RoHS exemption.

Green: TI defines "Green" to mean the content of Chlorine (Cl) and Bromine (Br) based flame retardants meet JS709B low halogen requirements of <=1000ppm threshold. Antimony trioxide based flame retardants must also meet the <=1000ppm threshold requirement.

(3) MSL, Peak Temp. - The Moisture Sensitivity Level rating according to the JEDEC industry standard classifications, and peak solder temperature.

(4) There may be additional marking, which relates to the logo, the lot trace code information, or the environmental category on the device.

(5) Multiple Device Markings will be inside parentheses. Only one Device Marking contained in parentheses and separated by a "-" will appear on a device. If a line is indented then it is a continuation of the previous line and the two combined represent the entire Device Marking for that device.

(6) Lead/Ball Finish - Orderable Devices may have multiple material finish options. Finish options are separated by a vertical ruled line. Lead/Ball Finish values may wrap to two lines if the finish value exceeds the maximum column width.

Important Information and Disclaimer: The information provided on this page represents TI's knowledge and belief as of the date that it is provided. TI bases its knowledge and belief on information provided by third parties, and makes no representation or warranty as to the accuracy of such information. Efforts are underway to better integrate information from third parties. TI has taken and continues to take reasonable steps to provide representative and accurate information but may not have conducted destructive testing or chemical analysis on incoming materials and chemicals. TI and TI suppliers consider certain information to be proprietary, and thus CAS numbers and other limited information may not be available for release.

In no event shall TI's liability arising out of such information exceed the total purchase price of the TI part(s) at issue in this document sold by TI to Customer on an annual basis.

TAPE AND REEL INFORMATION



QUADRANT ASSIGNMENTS FOR PIN 1 ORIENTATION IN TAPE



*All dimensions are nominal

Device	Package Type	Package Drawing	Pins	SPQ	Reel Diameter (mm)	Reel Width W1 (mm)	A0 (mm)	B0 (mm)	K0 (mm)	P1 (mm)	W (mm)	Pin1 Quadrant
TL714CDR	SOIC	D	8	2500	330.0	12.4	6.4	5.2	2.1	8.0	12.0	Q1

TAPE AND REEL BOX DIMENSIONS

*All dimensions are nominal

Device	Package Type	Package Drawing	Pins	SPQ	Length (mm)	Width (mm)	Height (mm)
TL714CDR	SOIC	D	8	2500	340.5	338.1	20.6



D0008A

PACKAGE OUTLINE

SOIC - 1.75 mm max height

SMALL OUTLINE INTEGRATED CIRCUIT



4214825/C 02/2019

NOTES:

- Linear dimensions are in inches [millimeters]. Dimensions in parenthesis are for reference only. Controlling dimensions are in inches. Dimensioning and tolerancing per ASME Y14.5M.
- This drawing is subject to change without notice.
- This dimension does not include mold flash, protrusions, or gate burrs. Mold flash, protrusions, or gate burrs shall not exceed .006 [0.15] per side.
- This dimension does not include interlead flash.
- Reference JEDEC registration MS-012, variation AA.

EXAMPLE BOARD LAYOUT

D0008A

SOIC - 1.75 mm max height

SMALL OUTLINE INTEGRATED CIRCUIT



LAND PATTERN EXAMPLE
EXPOSED METAL SHOWN
SCALE:8X



SOLDER MASK DETAILS

4214825/C 02/2019

NOTES: (continued)

6. Publication IPC-7351 may have alternate designs.

7. Solder mask tolerances between and around signal pads can vary based on board fabrication site.

EXAMPLE STENCIL DESIGN

D0008A

SOIC - 1.75 mm max height

SMALL OUTLINE INTEGRATED CIRCUIT



SOLDER PASTE EXAMPLE
BASED ON .005 INCH [0.125 MM] THICK STENCIL
SCALE:8X

4214825/C 02/2019

NOTES: (continued)

8. Laser cutting apertures with trapezoidal walls and rounded corners may offer better paste release. IPC-7525 may have alternate design recommendations.
9. Board assembly site may have different recommendations for stencil design.

P (R-PDIP-T8)

PLASTIC DUAL-IN-LINE PACKAGE

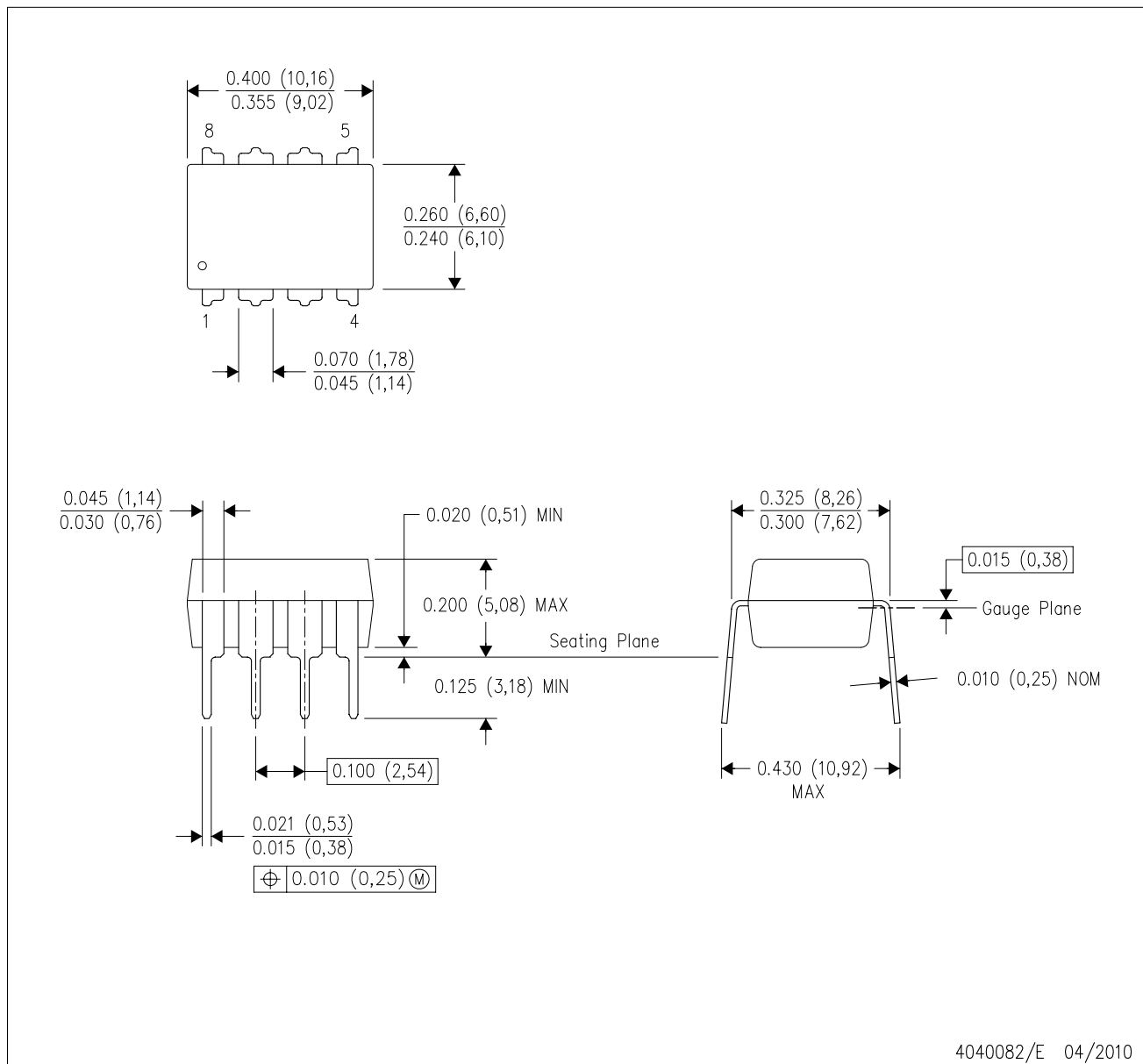

- NOTES:
- A. All linear dimensions are in inches (millimeters).
 - B. This drawing is subject to change without notice.
 - C. Falls within JEDEC MS-001 variation BA.

IMPORTANT NOTICE AND DISCLAIMER

TI PROVIDES TECHNICAL AND RELIABILITY DATA (INCLUDING DATASHEETS), DESIGN RESOURCES (INCLUDING REFERENCE DESIGNS), APPLICATION OR OTHER DESIGN ADVICE, WEB TOOLS, SAFETY INFORMATION, AND OTHER RESOURCES "AS IS" AND WITH ALL FAULTS, AND DISCLAIMS ALL WARRANTIES, EXPRESS AND IMPLIED, INCLUDING WITHOUT LIMITATION ANY IMPLIED WARRANTIES OF MERCHANTABILITY, FITNESS FOR A PARTICULAR PURPOSE OR NON-INFRINGEMENT OF THIRD PARTY INTELLECTUAL PROPERTY RIGHTS.

These resources are intended for skilled developers designing with TI products. You are solely responsible for (1) selecting the appropriate TI products for your application, (2) designing, validating and testing your application, and (3) ensuring your application meets applicable standards, and any other safety, security, or other requirements. These resources are subject to change without notice. TI grants you permission to use these resources only for development of an application that uses the TI products described in the resource. Other reproduction and display of these resources is prohibited. No license is granted to any other TI intellectual property right or to any third party intellectual property right. TI disclaims responsibility for, and you will fully indemnify TI and its representatives against, any claims, damages, costs, losses, and liabilities arising out of your use of these resources.

TI's products are provided subject to TI's Terms of Sale (www.ti.com/legal/termsofsale.html) or other applicable terms available either on ti.com or provided in conjunction with such TI products. TI's provision of these resources does not expand or otherwise alter TI's applicable warranties or warranty disclaimers for TI products.

Mailing Address: Texas Instruments, Post Office Box 655303, Dallas, Texas 75265
Copyright © 2020, Texas Instruments Incorporated