

# 300 & 400 SERIES - MINIATURE PUSHBUTTON SWITCHES



## FEATURES

- Dry circuit through power ratings .
- Compact size SPST momentary and alternate action models with numerous options.
- Panel, panel & p.c. and p.c. mounting models, lighted and unlighted.

## SPECIFICATIONS

### Contact ratings & life:

(Q) power models - coin silver: 1 Amp at 125 VAC or 28 VDC or 0.5 Amps at 250 VAC - electric life 250,000 cycles min. 3 Amps at 125 VAC or 28 VDC, or 1.5 Amps at 250 VAC - electric life 10,000 cycles min. (All previous loads are resistive).

(B) dry circuit models - gold over nickel over brass: 0.4 VA max. at 20 V max.- electric life 250,000 cycles min.

UL models - coin silver: 1 Amp at 125 VAC or 0.5 Amps at 250 VAC (75% power factor). UL file no. E66367.

### Initial contact resistance:

10 milliohms max. at 3 VDC, 0.1 Amp.

### Insulation resistance:

Greater than 10,000 megohms.

### Dielectric strength:

1000 Volts RMS min. at sea level.

### Operating temperature range:

-30°C to +85°C

## MATERIALS

### Contacts:

Coin silver for power & UL models. Gold over nickel over brass for dry circuit models.

### Actuator:

Nylon. Black color is standard for 300 Series. White is standard for 400 Series.

### Bushing:

Nickel plated brass

### Base:

DAP, color blue.

### Terminal seal:

Epoxy (standard)

### Support bracket:

Brass or steel, tin plated

### Spring mounting bracket:

Stainless steel

### Bezel & cap:

Nylon. Available in black, red or white. Consult factory for other colors.

### Hardware:

See Miscellaneous section.

### LED:

Intensity: 2.0 mcd at 10 mA. Forward voltage: 2.0V (3.0V max.). Max. continuous forward current: 30 mA at 25°C. Red standard - yellow & green are optional. Specifications are subject to change without notice - consult factory.

## AGENCY RECOGNITION



UL Marking: Switches ordered with '/UL' added at end of model no. are supplied with recognized mark.

## ABOUT THIS SERIES

The material in this series is organized in the following sequence:

- Completely specified switch models & options
- 'build your own switch' order format
- Additional options & panel cut-outs

# 300 & 400 SERIES - MINIATURE PUSHBUTTON SWITCHES

## 300 SERIES SPST Momentary (Normally open or normally closed)



White actuator optional - black is standard

Switch caps optional - see Hardware section of catalog.

(Q) Power Model No.	(B) Dry ckt. Model No.	UL Model No.
301ZQE	301ZBE	301ZQE/UL
302ZQE	302ZBE	302ZQE/UL
305ZQE	305ZBE	305ZQE/UL
306ZQE	306ZBE	306ZQE/UL

\* indicates 'Q' option not available for these models

### 302

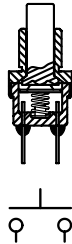
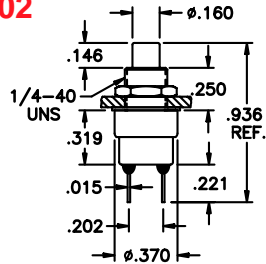

N.O. without overtravel  
Total travel: .060  
Actuation force: 10 oz. ± 4 oz.

### 301

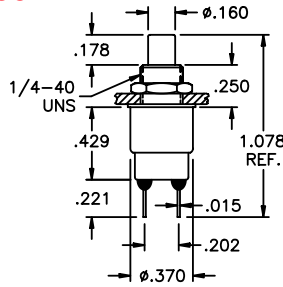

N.O. with overtravel  
Total travel: .110  
Overtravel: .020 min.  
Actuation force: 8.5 oz. ± 4 oz.

### 305

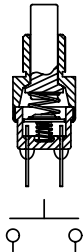
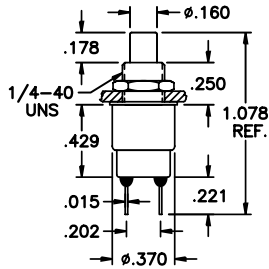

N.O. with more overtravel than 301  
Total travel: .110  
Pretravel to contact closure: .030  
Actuation force to contact closure: 3 oz.  
Overtravel: .075  
Actuation force at full travel: 8 oz.

### 306

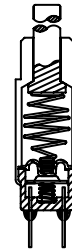
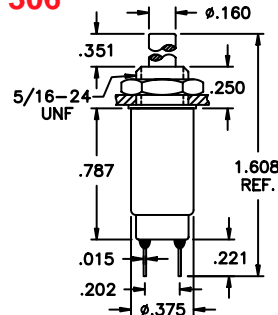

N.O. with sealed contact area and maximum overtravel.  
Total travel: .310  
Pretravel to contact closure: .025  
Actuator force to contact closure: 1.5 oz.  
Overtravel: .250 minimum  
Actuation force at full travel: 9 oz.  
Note: Electrical or mechanical life for this model is 20,000 cycles.

## 400 SERIES (401 Push on/ push off, 402 N.O. momentary)



Black actuator optional - white is standard

(Q) Power Model No.	(B) Dry ckt. Model No.	UL Model No.
401ZQE	401ZBE	401ZQE/UL
402ZQE	402ZBE	402ZQE/UL

### SNAP-ACTION MECHANISM

Pretravel to contact closure: .026  
Travel to actuate switch: .106  
Total travel: .137  
Force to actuate switch: 22 oz.  
Force at maximum travel: 35 oz.  
Mechanical life: 1,000,000 cycles minimum

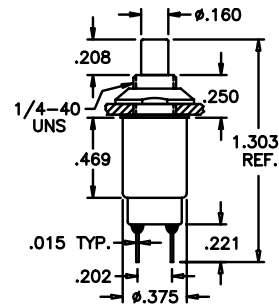

NOTE: When using sealing boot U5321 with 400 Series switches, add 'S1' to model number.

United States Patent 4,319,106

Switchcaps optional - see Hardware section of catalog.

## OPTIONS

### Colored operating actuator

Available in dyed nylon. To specify, add digit at end of model number - 1 blue, 2 black, 3 green, 5 yellow, 6 red, 7/1 white or 9 orange. Black is standard for 300 Series. White is standard for 400 Series.

### Z

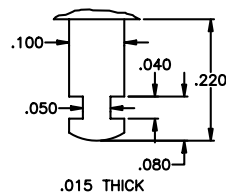

Solder lug terminal

### C

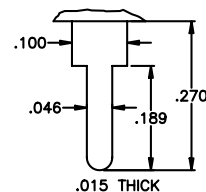

Printed circuit terminal

### E (standard)

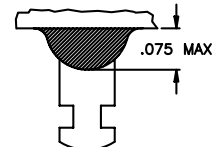

Epoxy seal

# 300 & 400 SERIES - MINIATURE PUSHBUTTON SWITCHES

## OPTIONS FOR SELECTIVE MODELS ONLY

### Options V30

For models 301, 302 & 305 only

Straight p.c. terminals w/bracket

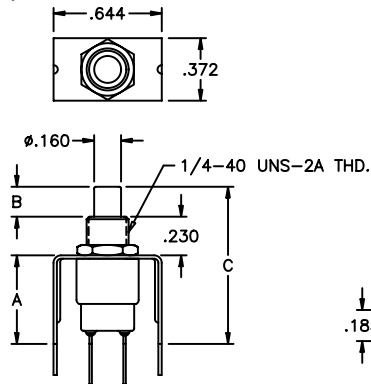

MODEL NO.	*OPTION	DIM. A	DIM. B	DIM. C.	DIM. D.
301,305	V30	.527	.173	.933	.237
302	V30	.527	.150	.910	.125

\* Options V31 with crimped leg design also available - see prior page.

TO SPECIFY, ADD OPTION FROM BOX TO SWITCH MODEL NO. - EXAMPLE: 302V31BE

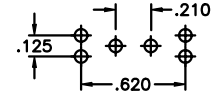

P.C. BOARD LAYOUT

### Options V & V-1 Right angle terminals w/bracket

For models 301, 302, 305, 401 & 402 only

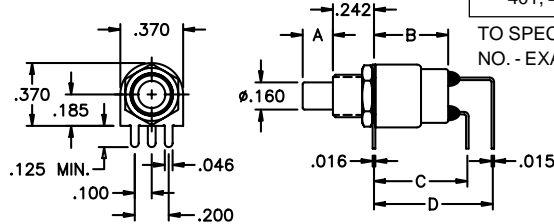
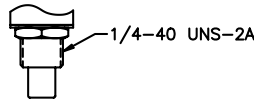

MODEL NO.	OPTION	DIM. A	DIM. B	DIM. C.	DIM. D.
301, 305	V	.173	.439	.550	.700
301, 305	V-1	.173	.439	.550	.650
302	V	.150	.327	.450	.600
302	V-1	.150	.327	.450	.550
401, 402	V	.210	.653	.750	.900
401, 402	V-1	.210	.653	.750	.850

TO SPECIFY, ADD OPTION FROM BOX TO SWITCH MODEL NO. - EXAMPLE: 301V-1BE

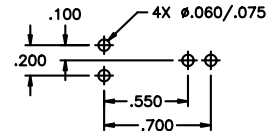

P.C. BOARD LAYOUT

Support Bracket is Brass, Solder Coated. Available with B, N, or T Contact Materials. (See pg. C29)

Supplied with Epoxy Sealed Terminals.

Note: Terminals are not fully bent, to facilitate spring retention in p.c. board.

SPECIFICATIONS SUBJECT TO CHANGE WITHOUT NOTICE

L

# 300 & 400 SERIES - MINIATURE PUSHBUTTON SWITCHES

## OPTIONS FOR SELECTIVE MODELS ONLY

**Option T1** 15/32" bushing mounts from front or rear of panel  
For models 301, 303 & 305 only

MODEL NO.	A
301,305	.250

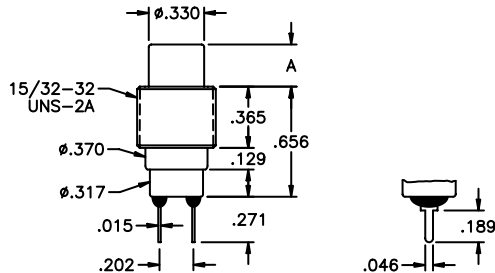

TO SPECIFY, ADD 'T1' TO SWITCH MODEL NO. - EXAMPLE: 301T1CQE6

Threaded bushing: Brass, nickel plated  
Actuator button: Nylon. Specify color - see order format.

Supplied with 2 Hex Nuts, p/n A465 & 1 Lockwasher, p/n A466 (see Hardware section of catalog).

Printed circuit or solder lug terminals available.

**Option S** Long actuator  
For models 301, 302, 305, 401 & 402 only

TO SPECIFY, ADD 'S' TO SWITCH MODEL NO. - EXAMPLE: 301SCQE

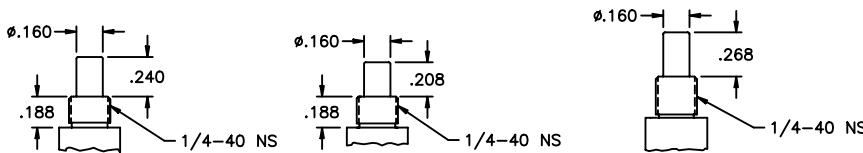

301 & 305

302

401 & 402

Actuator: Nylon  
Color: Black standard for 300 Series  
White standard for 400 Series.  
Other colors available - see options.

NOTE: When using sealing boot U5321 with 400 Series switches, add 'S1' to model number. This option is not illustrated.

**Additional ordering information:** Commonly ordered models are shown above and on prior pages with complete model numbers and specifications. Below is an order format that enables you to 'build your own switch' and specify the correct switch model number by simply selecting from all available options shown and filling in the boxes.

## 'BUILD YOUR OWN SWITCH' ORDER FORMAT

Fill in boxes with selections shown for **Model Structure**, then add **Options** selections for complete model number. Allowable options are shown below each respective box with brief description - see option dwgs. & info. following. Notes: 'NONE' indicates box may be left empty. Not all combinations can be made - see other pages of Series.

### Model Structure:

Series	Actuators	Bushings	Terminations	Contact materials	Sealing
<input type="text"/>	<input type="text"/>	<input type="text"/>	<input type="text"/>	<input type="text"/>	<input type="text"/>
3 0 1	(NONE)	(NONE)	Z Solder lug	B Gold	Epoxy
3 0 2	S Long (see	T 1 15/32" thd'd.	C Printed circuit	Q Coin silver	terminal
3 0 5	dwg. - specify	(see dwg -	V Right angle p.c. term-	(Not avail-	seal is
3 0 6	for all models	for 301,	V - 1 inals for 301, 302, 305,	able with	standard
4 0 1	with bezels-	303 & 305	401 & 402 only (see dwg.).	303 & 304)	
4 0 2	not available	only).	V 3 0 Straight p.c. terminals	N Economy	
	for 306).			gold	
	S 1 For			T Economy	
	400 Series			silver	
	switches used				
	with sealing				
	boot U5321				
	only.				

Recognitions

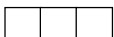

(NONE)  
/UL

Switch caps for switches without bezels also available - see Hardware section of catalog.

Example of completely specified model number:  
**301SZQE/UL**

Although most combinations of options are available, some may result in incompatibilities. Consult factory if there is any question.

# 300 & 400 SERIES - MINIATURE PUSHBUTTON SWITCHES

## CONTACT MATERIAL OPTIONS

- B** Dry circuit - gold over nickel over brass.  
 RATING: 0.4 Volt-Amps (VA) max. at 20 V max.  
 ELECTRIC LIFE: 250,000 cycles minimum.
- Q** Power circuit - coin silver.  
 RATING: 1 Amp at 120 VAC or 28 VDC or 0.5 Amps at 250 VAC. ELECTRIC LIFE: 250,000 cycles minimum at full load.  
 Also - 3 Amps at 120 VAC or 28 VDC or 1.5 Amps at 250 VAC. ELECTRIC LIFE: 10,000 cycles minimum at full load.
- G** Dry circuit or power circuit - gold over nickel over coin silver  
 RATINGS & ELECTRIC LIFE: Same as B & Q above -i.e.- can be used in either dry circuit or power circuit, however once used in power circuit, switch cannot be re-used in dry circuit. This option permits customers to inventory one switch to satisfy either application,
- N** Dry circuit - gold over nickel over coin silver.  
 RATING: 0.4 Volt-Amps (VA) max. at 20 V max. Note- less gold than B option.  
 ELECTRIC LIFE: 10,000 cycles min. at 13 cycles per minute.
- T** Power circuit - Silver plate over brass.  
 RATING: 0.5 Amps at 120 VAC or 0.25 Amps at 250 VAC (resistive loads).  
 ELECTRIC LIFE: 10,000 cycles min. at 13 cycles per minute.

Solder dipped terminals and custom contact plating available - contact factory.

## UL OPTION

- /UL** For power circuits - coin silver  
 RATING: 1.0 Amps at 125 VAC or 0.5 Amps at 250 VAC (75% power factor).  
 Underwriter Laboratories file no. E66367. Note - applicable only to terminations with coin silver contacts (Q or G options).

## HARDWARE

### HARDWARE SUPPLIED

(See Hardware section of catalog)

Panel mounted 300 Series switches with threaded 1/4" bushing are supplied with 1 Hex Nut A112 and 1 Lockwasher A115.

Panel mounted 300 Series switches with threaded 15/32" bushing are supplied with 2 Hex Nuts A465 and 1 Lockwasher A466.

Panel mounted 306 Series switches with threaded 5/16" bushing are supplied with 1 Hex Nut A713 and 1 Lockwasher A734.

Panel mounted 400 Series switches with threaded bushing are supplied with 1 Panel Dress Nut A274 and 1 Lockwasher A115.

## PANEL CUT-OUTS

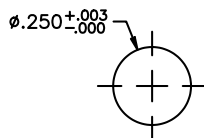

Accepts all 1/4" threaded bushings

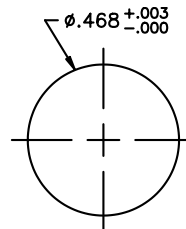

Accepts all 15/32" threaded bushings

SPECIFICATIONS SUBJECT TO CHANGE WITHOUT NOTICE

L

# Mouser Electronics

Authorized Distributor

Click to View Pricing, Inventory, Delivery & Lifecycle Information:

## [Apem:](#)

[401ZQE2](#) [302ZNE](#) [301ZQE](#) [303ZTE](#) [402ZQE](#) [305ZBE](#) [301CBE](#) [301SCBE](#) [301SZBE](#) [301ZBE](#) [302CBE](#)  
[302SZBEJ8182](#) [302SZQE](#) [302ZBE](#) [306ZBE](#) [306ZQE](#) [401SZQE](#) [402ZBE](#) [402ZQE2](#) [301T1ZQE2UL](#) [301ZQEUL](#)  
[301T1CBE2](#) [301T1CQE2](#) [301T1ZBE2](#) [301T1ZQE2](#) [302SCQE](#) [302ZQE](#) [306CBE](#) [306CQE](#) [401CQE2](#) [401ZBE](#)  
[402CQE](#) [401 ZQE](#) [402ZBE2](#) [305CBE](#) [305T1ZQE2](#) [301CQE](#) [401CQE](#) [302V1NE](#) [401ZQEUL](#) [302SZQEJ8126UL](#)  
[302V1BE](#) [301T1ZQE6UL](#) [302ZQEUL](#) [401ZQEA112](#) [301SZQEUL](#) [402SCQEJ8122](#) [402SCQEUL](#)