

### HALF-BRIDGE DRIVER

#### Features

- Floating channel designed for bootstrap operation
- Fully operational to +600 V
- Tolerant to negative transient voltage, dV/dt immune
- Gate drive supply range from 10 V to 20 V
- Undervoltage lockout
- 3.3 V, 5 V, and 15 V input logic compatible
- Cross-conduction prevention logic
- Internally set deadtime
- High-side output in phase with input
- Shutdown input turns off both channels
- Matched propagation delay for both channels
- RoHS compliant

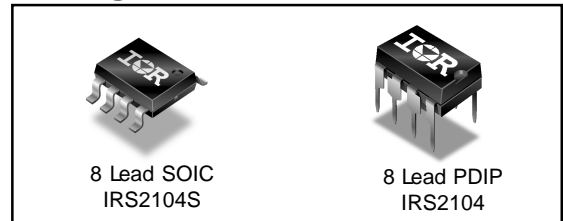
#### Product Summary

$V_{\text{OFFSET}}$	600 V max.
$I_{\text{O+/-}}$	130 mA/270 mA
$V_{\text{OUT}}$	10 V - 20 V
$t_{\text{on/off (typ.)}}$	680 ns/150 ns
Deadtime (typ.)	520 ns

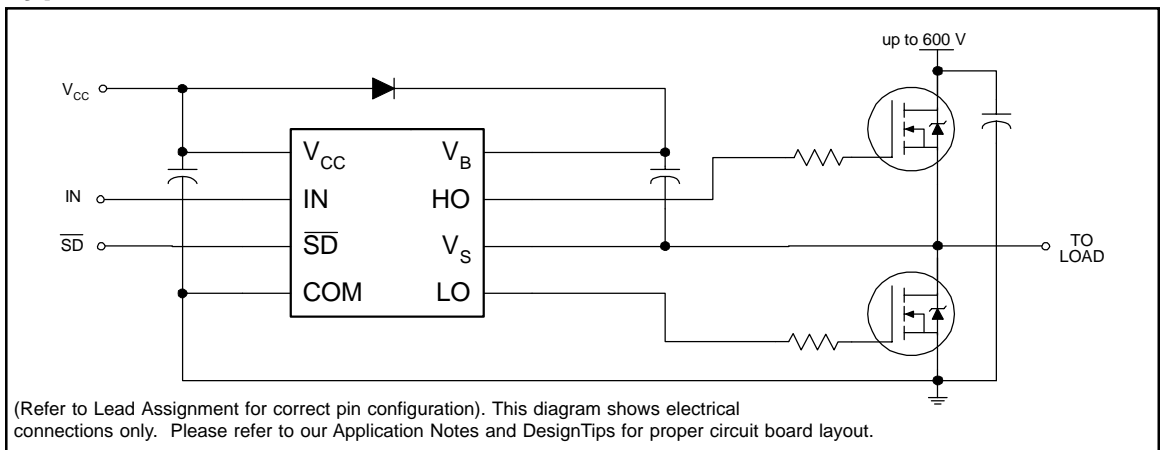
#### Description

The IRS2104 is a high voltage, high speed power MOSFET and IGBT driver with dependent high- and low-side referenced output channels. Proprietary HVIC and latch immune CMOS technologies enable ruggedized monolithic construction. The logic input is compatible with standard CMOS or LSTTL output, down to 3.3 V logic. The output drivers feature a high pulse current buffer stage designed for minimum driver cross-conduction. The floating channel can be used to drive an N-channel power MOSFET or IGBT in the high-side configuration which operates from 10 V to 600 V.

#### Packages



#### Typical Connection



## Absolute Maximum Ratings

Absolute maximum ratings indicate sustained limits beyond which damage to the device may occur. All voltage parameters are absolute voltages referenced to COM. The thermal resistance and power dissipation ratings are measured under board mounted and still air conditions.

Symbol	Definition	Min.	Max.	Units	
V <sub>B</sub>	High-side floating absolute voltage	-0.3	625	V	
V <sub>S</sub>	High-side floating supply offset voltage	V <sub>B</sub> - 25	V <sub>B</sub> + 0.3		
V <sub>HO</sub>	High-side floating output voltage	V <sub>S</sub> - 0.3	V <sub>B</sub> + 0.3		
V <sub>CC</sub>	Low-side and logic fixed supply voltage	-0.3	25		
V <sub>LO</sub>	Low-side output voltage	-0.3	V <sub>CC</sub> + 0.3		
V <sub>IN</sub>	Logic input voltage (IN & $\overline{SD}$ )	-0.3	V <sub>CC</sub> + 0.3		
dV <sub>S</sub> /dt	Allowable offset supply voltage transient	—	50	V/ns	
P <sub>D</sub>	Package power dissipation @ T <sub>A</sub> ≤ +25 °C	(8 lead PDIP)	—	1.0	W
		(8 lead SOIC)	—	0.625	
R <sub>thJA</sub>	Thermal resistance, junction to ambient	(8 lead PDIP)	—	125	°C/W
		(8 lead SOIC)	—	200	
T <sub>J</sub>	Junction temperature	—	150	°C	
T <sub>S</sub>	Storage temperature	-55	150		
T <sub>L</sub>	Lead temperature (soldering, 10 seconds)	—	300		

## Recommended Operating Conditions

The input/output logic timing diagram is shown in Fig. 1. For proper operation the device should be used within the recommended conditions. The V<sub>S</sub> offset rating is tested with all supplies biased at a 15 V differential.

Symbol	Definition	Min.	Max.	Units
V <sub>B</sub>	High-side floating supply absolute voltage	V <sub>S</sub> + 10	V <sub>S</sub> + 20	V
V <sub>S</sub>	High-side floating supply offset voltage	Note 1	600	
V <sub>HO</sub>	High-side floating output voltage	V <sub>S</sub>	V <sub>B</sub>	
V <sub>CC</sub>	Low-side and logic fixed supply voltage	10	20	
V <sub>LO</sub>	Low-side output voltage	0	V <sub>CC</sub>	
V <sub>IN</sub>	Logic input voltage (IN & $\overline{SD}$ )	0	V <sub>CC</sub>	
T <sub>A</sub>	Ambient temperature	-40	125	°C

Note 1: Logic operational for V<sub>S</sub> of -5 V to +600 V. Logic state held for V<sub>S</sub> of -5 V to -V<sub>BS</sub>. (Please refer to the Design Tip DT97-3 for more details).

**Dynamic Electrical Characteristics**

V<sub>BIAS</sub> (V<sub>CC</sub>, V<sub>BS</sub>) = 15 V, C<sub>L</sub> = 1000 pF and T<sub>A</sub> = 25 °C unless otherwise specified.

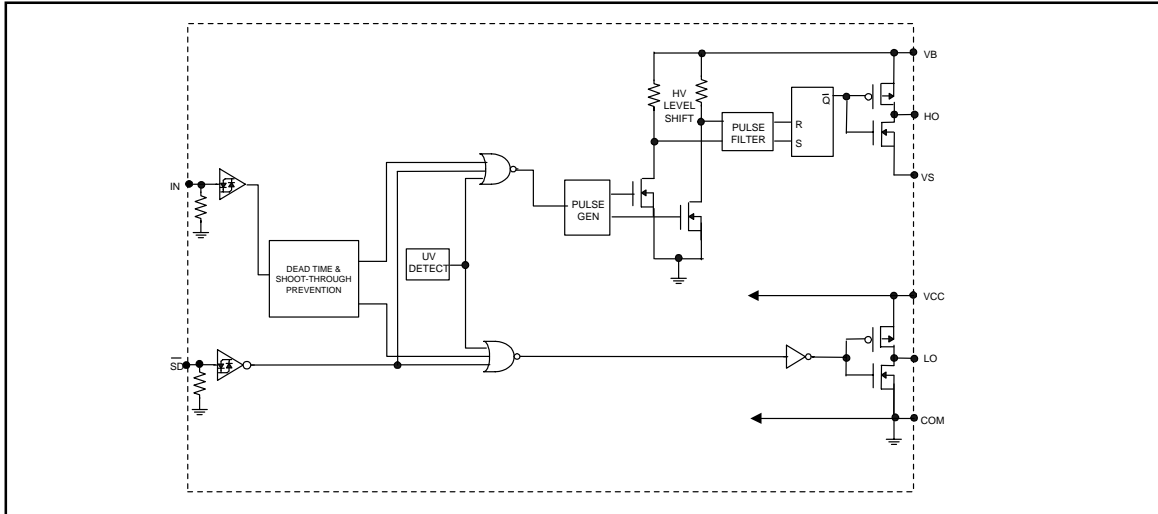
Symbol	Definition	Min.	Typ.	Max.	Units	Test Conditions
t <sub>on</sub>	Turn-on propagation delay	—	680	820	ns	V <sub>S</sub> = 0 V
t <sub>off</sub>	Turn-off propagation delay	—	150	220		V <sub>S</sub> = 600 V
t <sub>sd</sub>	Shutdown propagation delay	—	160	220		
t <sub>r</sub>	Turn-on rise time	—	70	170		
t <sub>f</sub>	Turn-off fall time	—	35	90		
DT	Deadtime, LS turn-off to HS turn-on & HS turn-on to LS turn-off	400	520	650		
MT	Delay matching, HS & LS turn-on/off	—	—	60		

**Static Electrical Characteristics**

V<sub>BIAS</sub> (V<sub>CC</sub>, V<sub>BS</sub>) = 15 V and T<sub>A</sub> = 25 °C unless otherwise specified. The V<sub>IN</sub>, V<sub>TH</sub>, and I<sub>IN</sub> parameters are referenced to COM. The V<sub>O</sub> and I<sub>O</sub> parameters are referenced to COM and are applicable to the respective output leads: HO or LO.

Symbol	Definition	Min.	Typ.	Max.	Units	Test Conditions
V <sub>IH</sub>	Logic “1” (HO) & Logic “0” (LO) input voltage	2.5	—	—	V	V <sub>CC</sub> = 10 V to 20 V
V <sub>IL</sub>	Logic “0” (HO) & Logic “1” (LO) input voltage	—	—	0.8		
V <sub>SD,TH+</sub>	SD input positive going threshold	2.5	—	—		
V <sub>SD,TH-</sub>	SD input negative going threshold	—	—	0.8		
V <sub>OH</sub>	High level output voltage, V <sub>BIAS</sub> - V <sub>O</sub>	—	0.05	0.2		
V <sub>OL</sub>	Low level output voltage, V <sub>O</sub>	—	0.02	0.1		
I <sub>LK</sub>	Offset supply leakage current	—	—	50	μA	V <sub>B</sub> = V <sub>S</sub> = 600 V
I <sub>QBS</sub>	Quiescent V <sub>BS</sub> supply current	—	30	55		V <sub>IN</sub> = 0 V or 5 V
I <sub>QCC</sub>	Quiescent V <sub>CC</sub> supply current	—	150	270		
I <sub>IN+</sub>	Logic “1” input bias current	—	3	10		V <sub>IN</sub> = 5 V
I <sub>IN-</sub>	Logic “0” input bias current	—	—	5	V <sub>IN</sub> = 0 V	
V <sub>CCUV+</sub>	V <sub>CC</sub> supply undervoltage positive going threshold	8	8.9	9.8	V	
V <sub>CCUV-</sub>	V <sub>CC</sub> supply undervoltage negative going threshold	7.4	8.2	9		
I <sub>O+</sub>	Output high short circuit pulsed current	130	290	—	mA	V <sub>O</sub> = 0 V PW ≤ 10 μs
I <sub>O-</sub>	Output low short circuit pulsed current	270	600	—		V <sub>O</sub> = 15 V PW ≤ 10 μs

## Functional Block Diagram



## Lead Definitions

Symbol	Description
IN	Logic input for high-side and low-side gate driver outputs (HO and LO), in phase with HO
$\overline{SD}$	Logic input for shutdown
$V_B$	High-side floating supply
HO	High-side gate drive output
$V_S$	High-side floating supply return
$V_{CC}$	Low-side and logic fixed supply
LO	Low-side gate drive output
COM	Low-side return

## Lead Assignments

<p>8 Lead PDIP</p>	<p>8 Lead SOIC</p>
<b>IRS2104PbF</b>	<b>IRS2104SPbF</b>

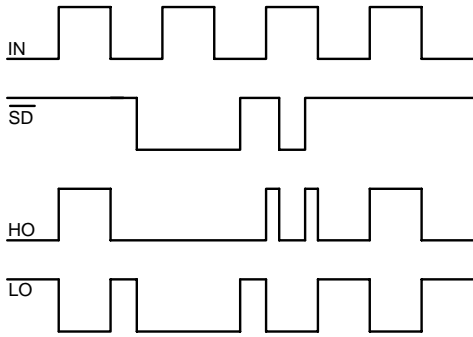


Figure 1. Input/Output Timing Diagram

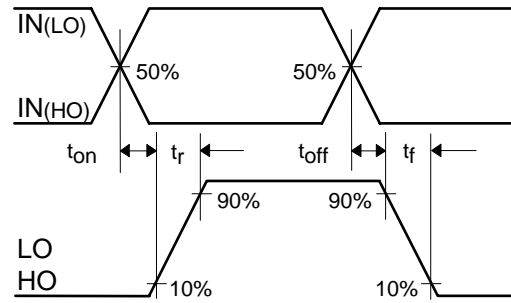


Figure 2. Switching Time Waveform Definitions

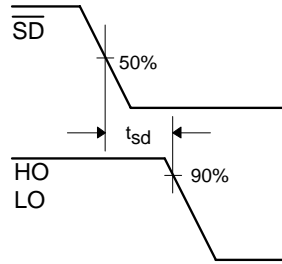


Figure 3. Shutdown Waveform Definitions

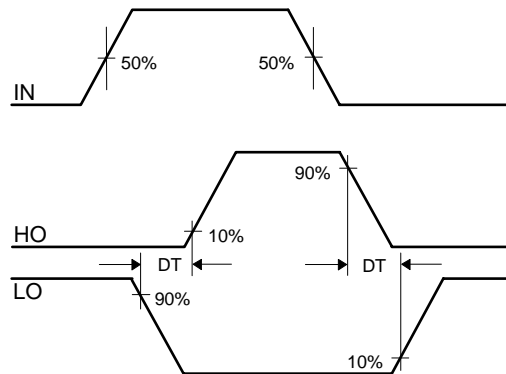


Figure 4. Deadtime Waveform Definitions

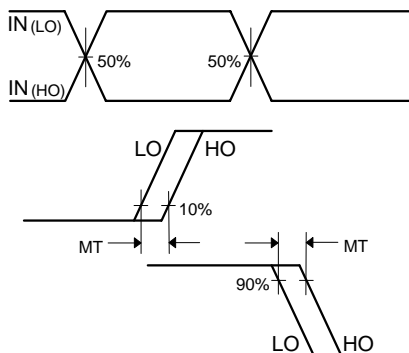


Figure 5. Delay Matching Waveform Definitions

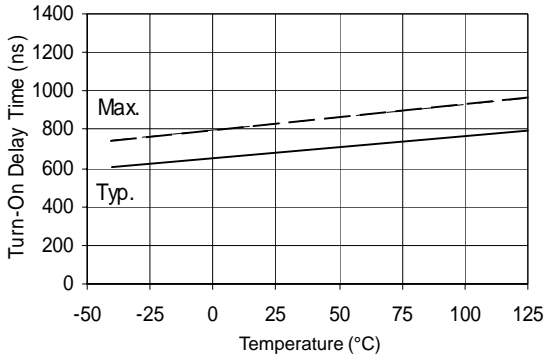


Figure 6A. Turn-On Time vs. Temperature

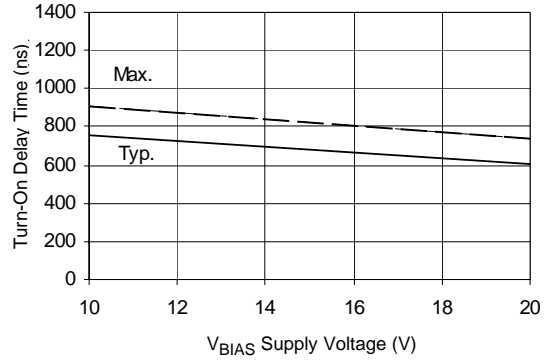


Figure 6B. Turn-On Time vs. Supply Voltage

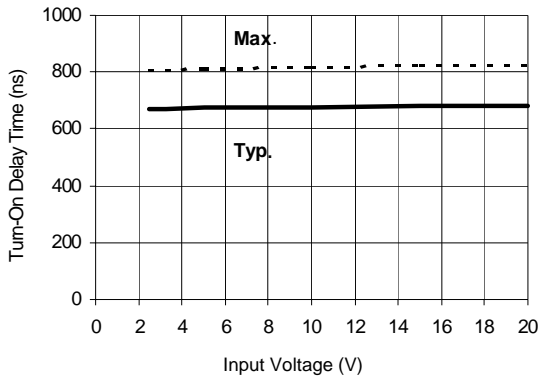


Figure 6C. Turn-On Time vs. Input Voltage

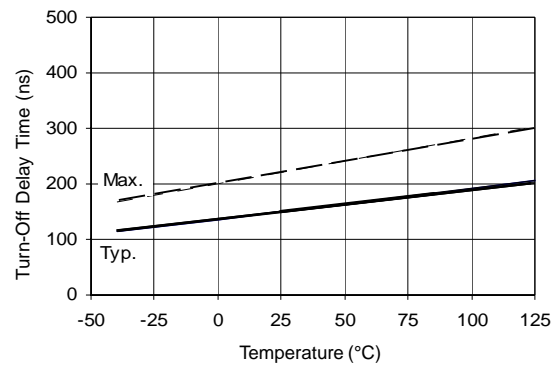


Figure 7A. Turn-Off Time vs. Temperature

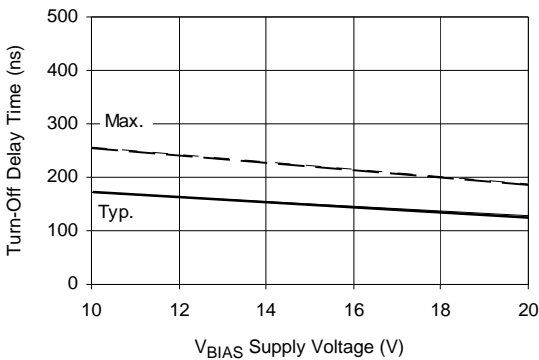


Figure 7B. Turn-Off Time vs. Supply Voltage

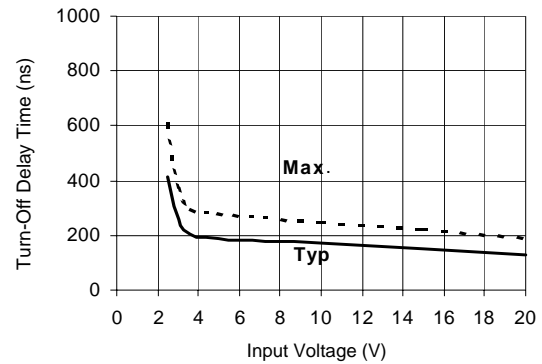
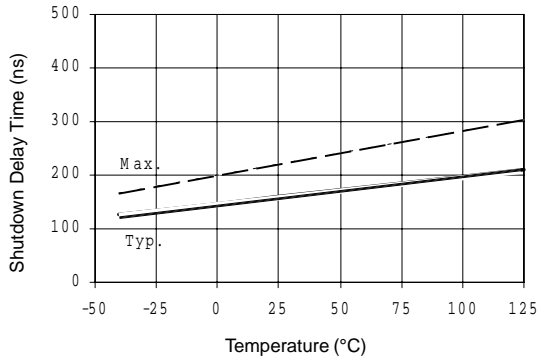
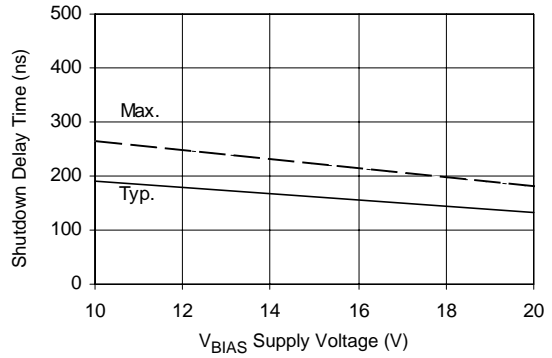


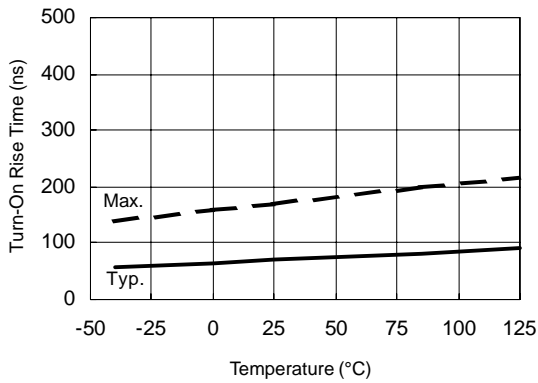
Figure 7C. Turn-Off Time vs. Input Voltage



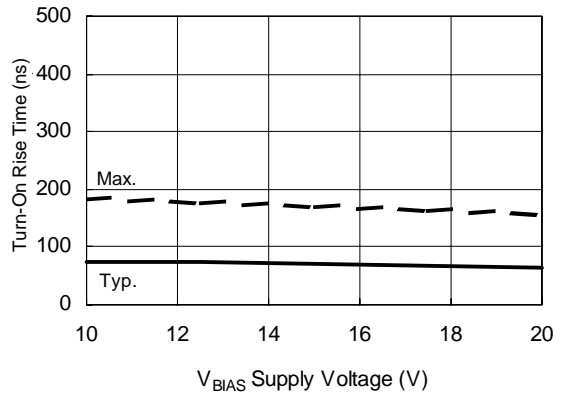
**Figure 8A. Shutdown Time vs. Temperature**



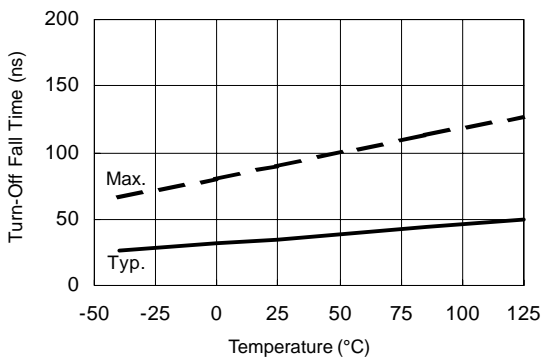
**Figure 8B. Shutdown Time vs. Voltage**



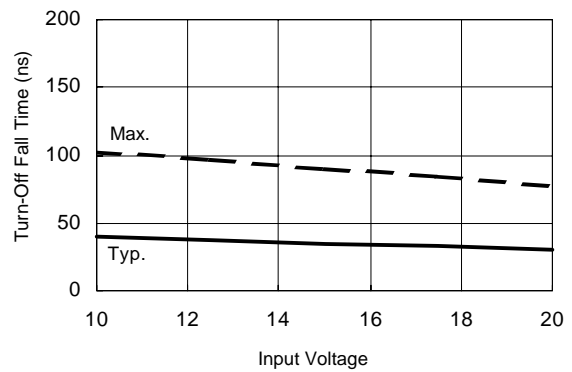
**Figure 9A. Turn-On Rise Time vs. Temperature**



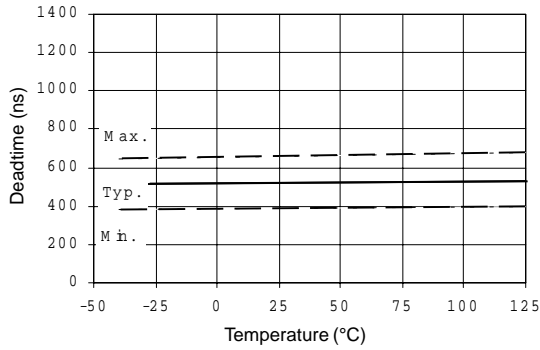
**Figure 9B. Turn-On Rise Time vs. Voltage**



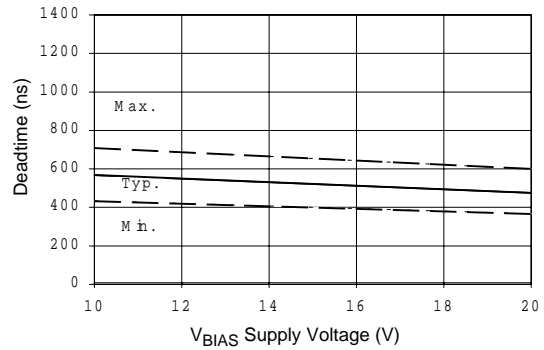
**Figure 10A. Turn-Off Fall Time vs. Temperature**



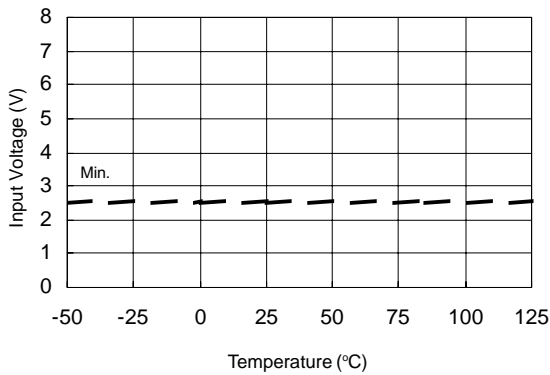
**Figure 10B. Turn-Off Fall Time vs. Input Voltage**



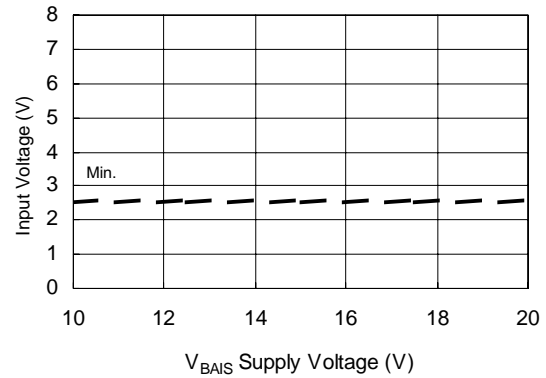
**Figure 11A. Deadtime vs. Temperature**



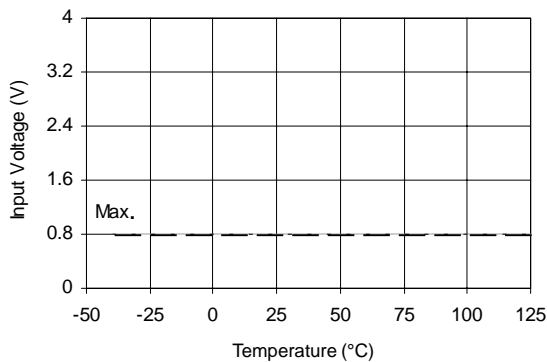
**Figure 11B. Deadtime vs. Voltage**



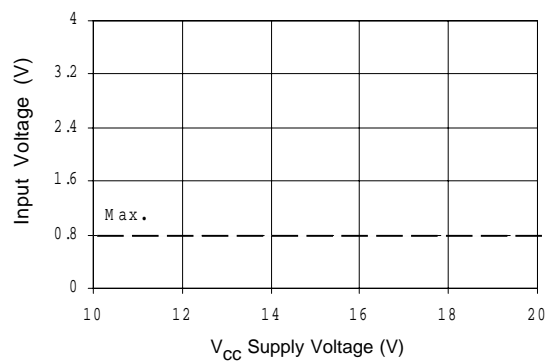
**Figure 12A. Logic "1" Input Voltage vs. Temperature**



**Figure 12B. Logic "1" Input Voltage vs. Supply Voltage**

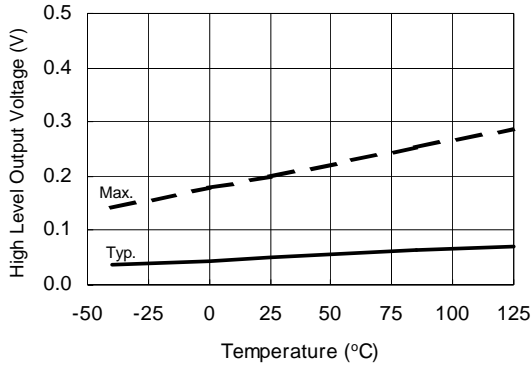


**Figure 13A. Logic "0" (HO) & Logic "1" (LO) & Active SD Input Voltage vs. Temperature**

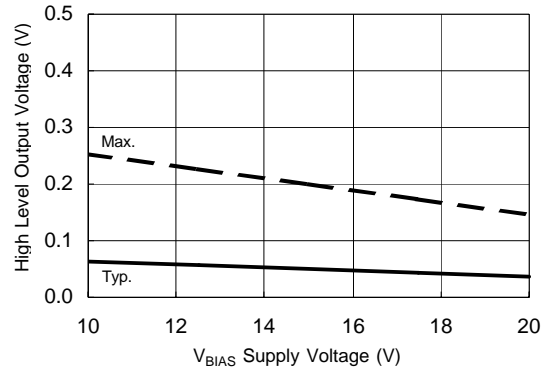


**Figure 13B. Logic "0" (HO) & Logic "1" (LO) & Active SD Input Voltage vs. Voltage**

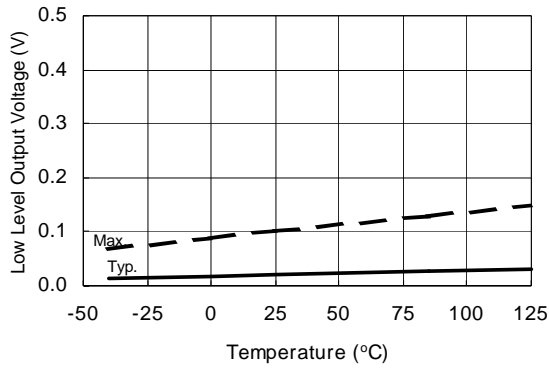




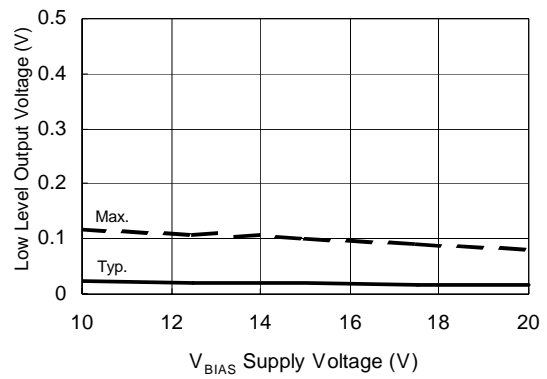
**Figure 14A. High Level Output Voltage vs. Temperature**



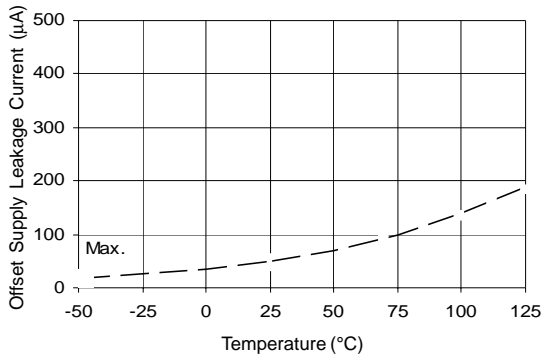
**Figure 14B. High Level Output Voltage vs. Supply Voltage**



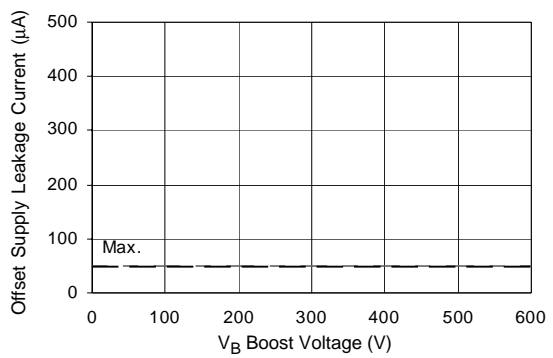
**Figure 15A. Low Level Output Voltage vs. Temperature**



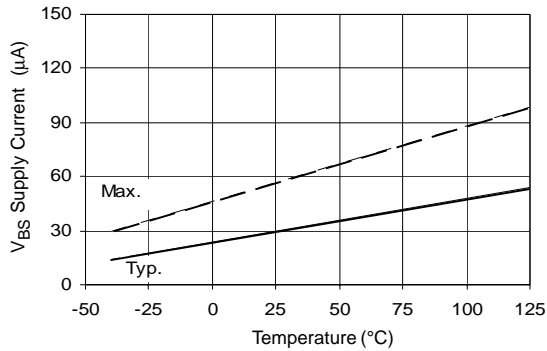
**Figure 15B. Low Level Output Voltage vs. Supply Voltage**



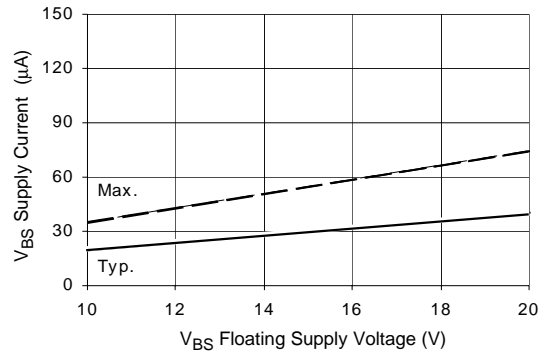
**Figure 16A. Offset Supply Current vs. Temperature**



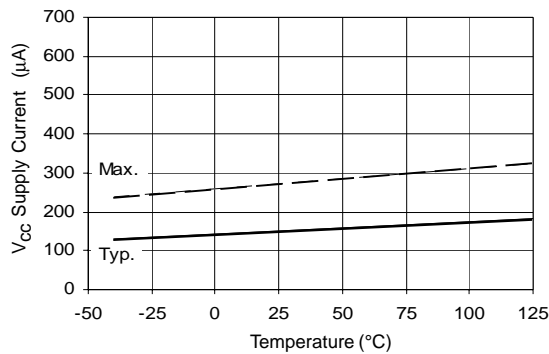
**Figure 16B. Offset Supply Current vs. Voltage**



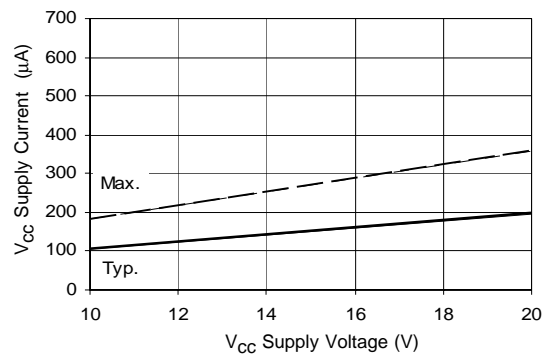
**Figure 17A. V<sub>BS</sub> Supply Current vs. Temperature**



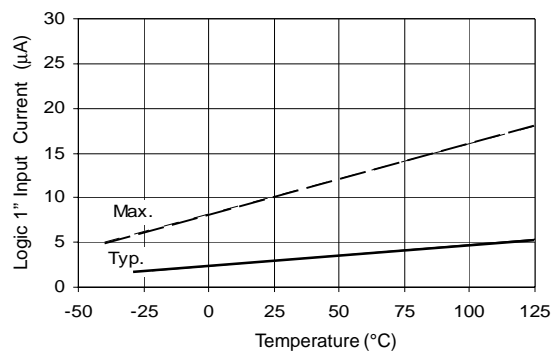
**Figure 17B. V<sub>BS</sub> Supply Current vs. Voltage**



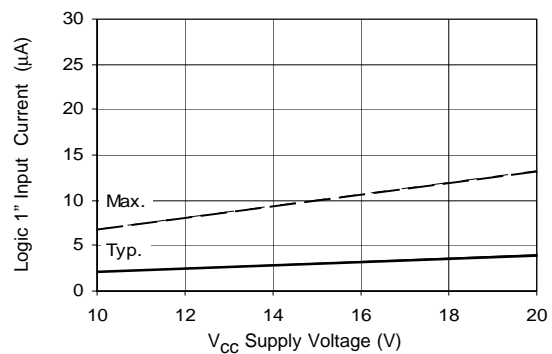
**Figure 18A. V<sub>CC</sub> Supply Current vs. Temperature**



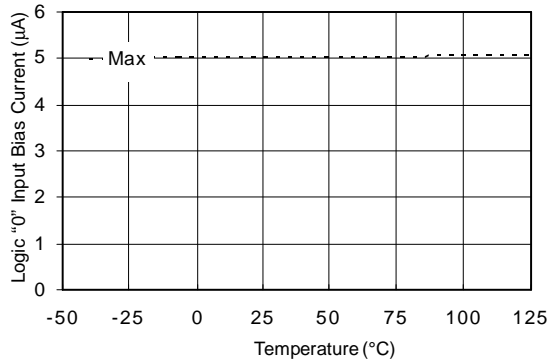
**Figure 18B. V<sub>CC</sub> Supply Current vs. Voltage**



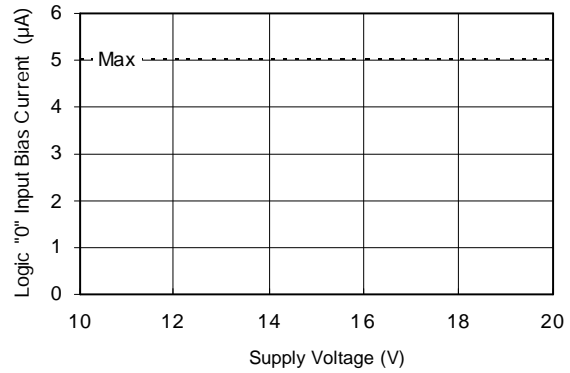
**Figure 19A. Logic "1" Input Current vs. Temperature**



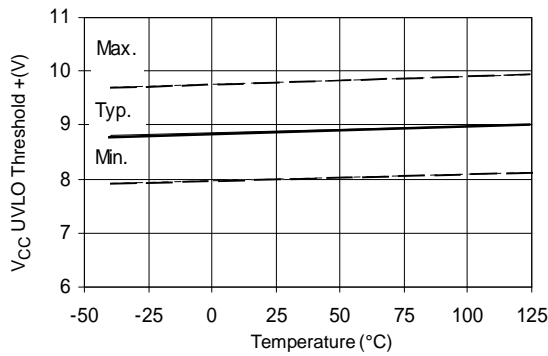
**Figure 19B. Logic "1" Input Current vs. Voltage**



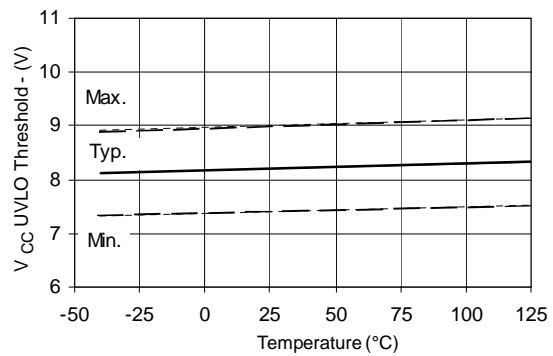
**Figure 20A. Logic "0" Input Bias Current vs. Temperature**



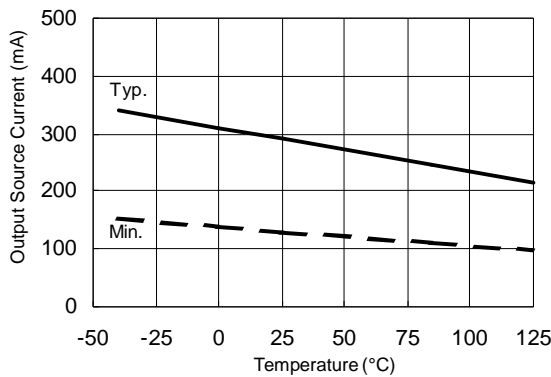
**Figure 20B. Logic "0" Input Bias Current vs. Voltage**



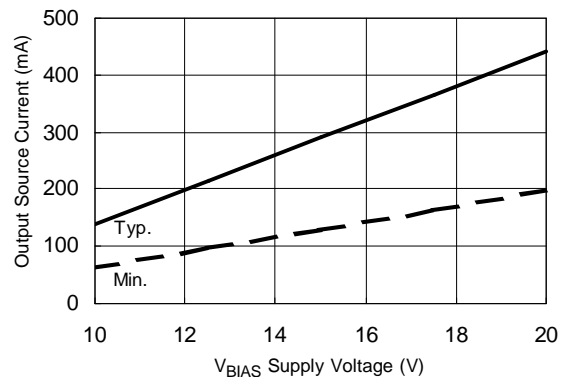
**Figure 21A. V<sub>CC</sub> Undervoltage Threshold(+) vs. Temperature**



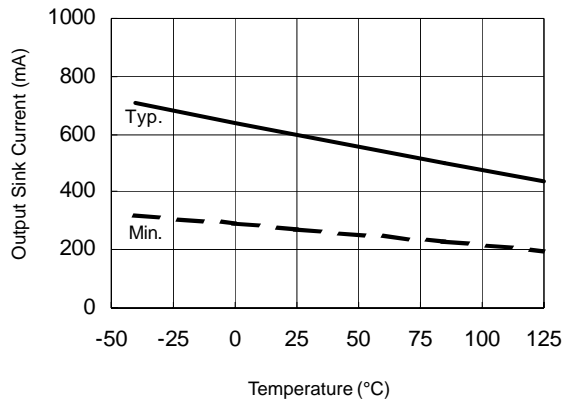
**Figure 21B. V<sub>CC</sub> Undervoltage Threshold(-) vs. Temperature**



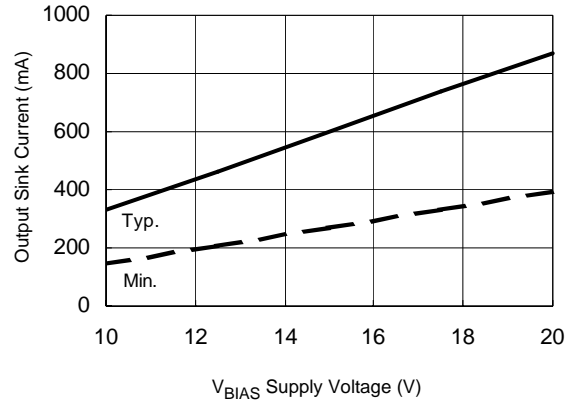
**Figure 22A. Output Source Current vs. Temperature**



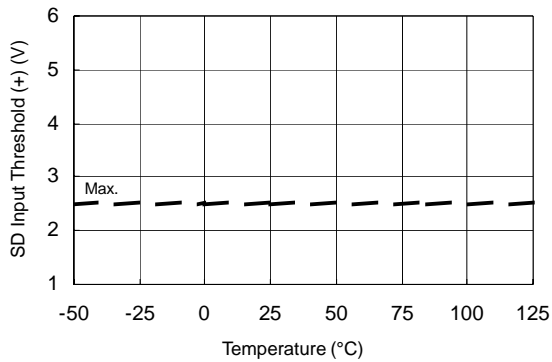
**Figure 22B. Output Source Current vs. Voltage**



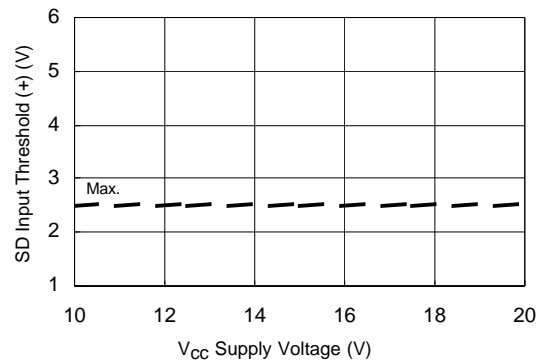
**Figure 23A. Output Sink Current vs. Temperature**



**Figure 23B. Output Sink Current vs. Supply Voltage**

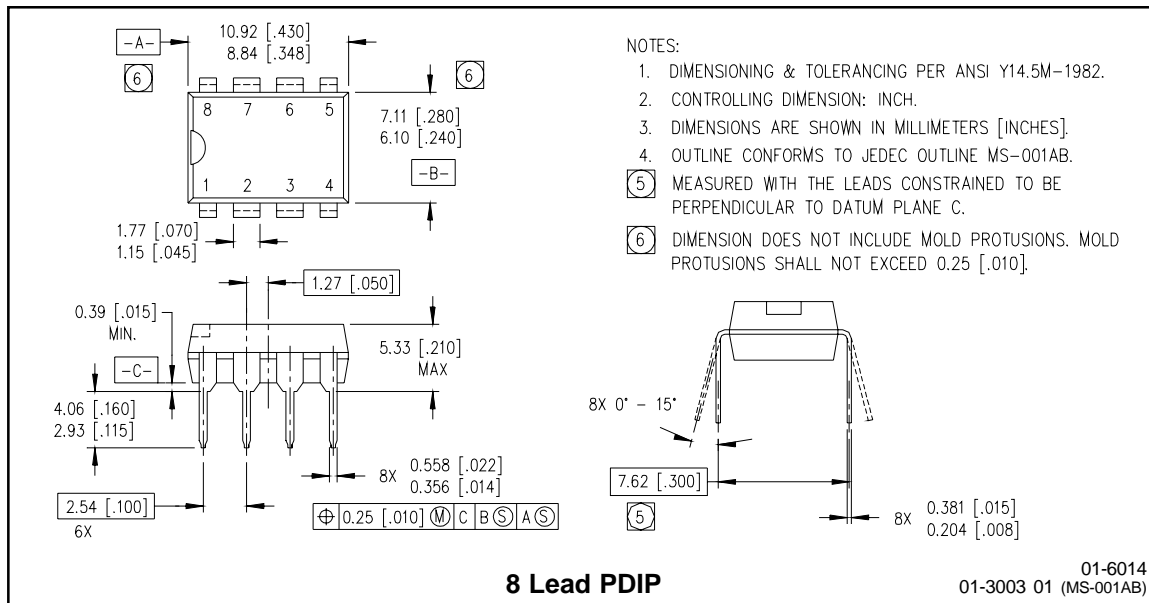
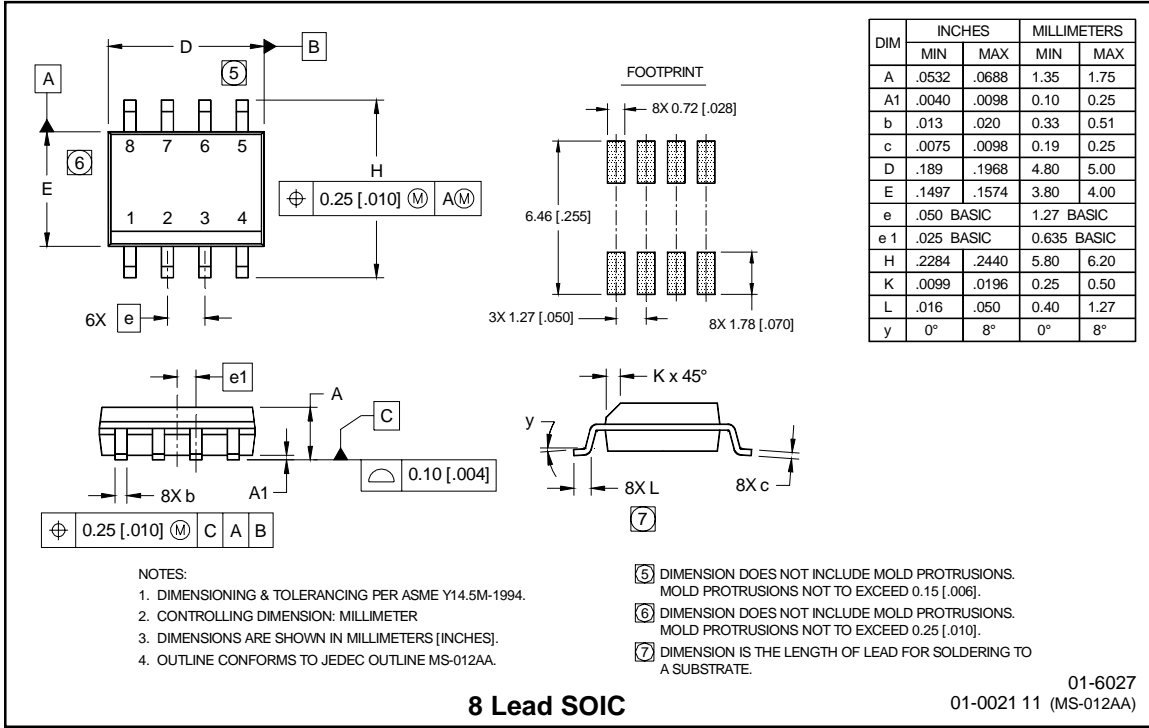


**Figure 24A. SD Input Positive Going Threshold (+) vs. Temperature**

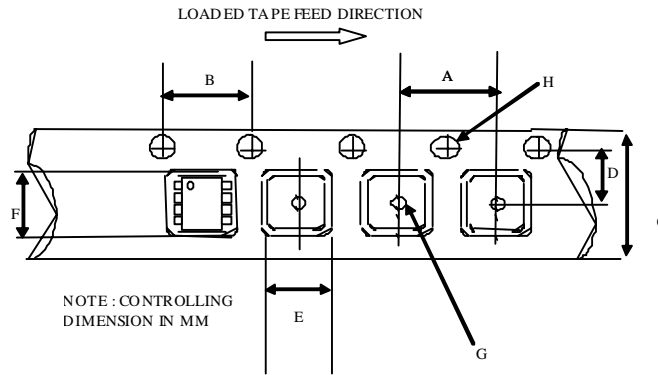


**Figure 24B. SD Input Positive Going Threshold (+) vs. Supply Voltage**

## Case Outline

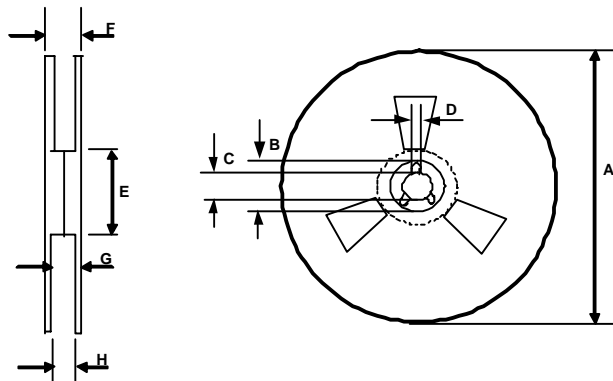


## Tape & Reel 8-lead SOIC



CARRIER TAPE DIMENSION FOR 8SOICN

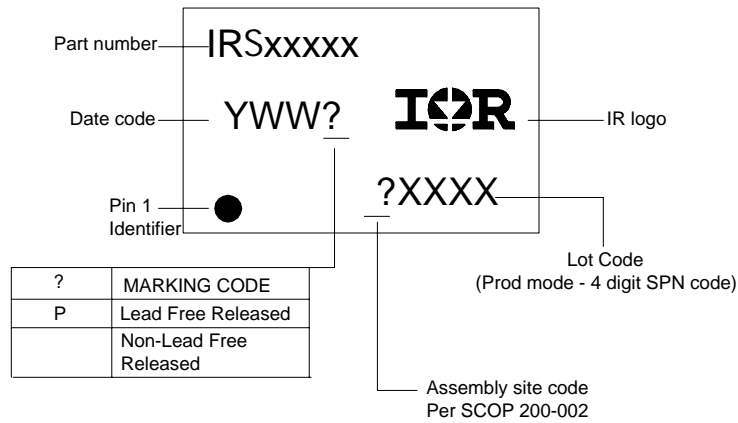
Code	Metric		Imperial	
	Min	Max	Min	Max
A	7.90	8.10	0.311	0.318
B	3.90	4.10	0.153	0.161
C	11.70	12.30	0.46	0.484
D	5.45	5.55	0.214	0.218
E	6.30	6.50	0.248	0.255
F	5.10	5.30	0.200	0.208
G	1.50	n/a	0.059	n/a
H	1.50	1.60	0.059	0.062



REEL DIMENSIONS FOR 8SOICN

Code	Metric		Imperial	
	Min	Max	Min	Max
A	329.60	330.25	12.976	13.001
B	20.95	21.45	0.824	0.844
C	12.80	13.20	0.503	0.519
D	1.95	2.45	0.767	0.096
E	98.00	102.00	3.858	4.015
F	n/a	18.40	n/a	0.724
G	14.50	17.10	0.570	0.673
H	12.40	14.40	0.488	0.566

## LEADFREE PART MARKING INFORMATION



## ORDER INFORMATION

- 8-Lead PDIP IRS2104PbF
- 8-Lead SOIC IRS2104SPbF
- 8-Lead SOIC Tape & Reel IRS2104STRPbF

# Mouser Electronics

Authorized Distributor

Click to View Pricing, Inventory, Delivery & Lifecycle Information:

[Infineon:](#)

[IRS2104SPBF](#) [IRS2104PBF](#) [IRS2104STRPBF](#)