

# Hi-Reliability Optically Coupled Isolator

## JAN / JANTX / JANTXV 4N22, 4N23, 4N24 [A]



### Features:

- TO-78 hermetically sealed package
- High current transfer ratio
- 1 kV electrical isolation
- Base contact provided for conventional transistor biasing
- JAN, JANTX and JANTXV devices processed to MIL-PRF-19500
- Patent No. 4124860

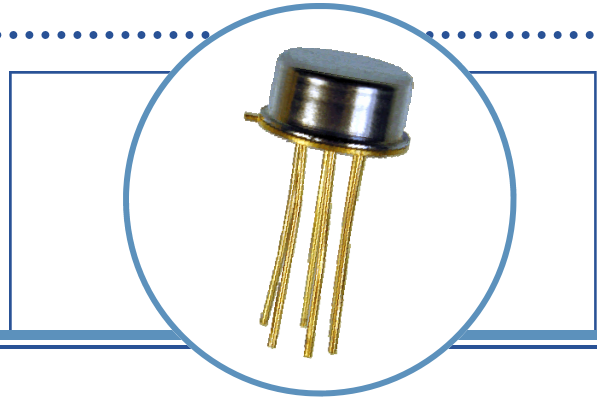

### Description:

Each isolator in this series consists of an infrared emitting diode and a NPN silicon phototransistor, which are mounted in a hermetically sealed TO-78 package. Devices are designed for military and/or harsh environments. The suffix letter "A" denotes the collector is electrically isolated from the case.

The JAN / JANTX / JANTXV 4N22, 4N22A, 4N23, 4N23A, 4N24, and 4N24A devices are processed to MIL-PRF-19500/486.

This series of 4N products are JEDEC registered, DSCC qualified.

Please contact your local representative or OPTEK for more information.

### Applications:

- High-voltage isolation between input and output
- Electrical isolation in dirty environments
- Industrial equipment
- Medical equipment
- Office

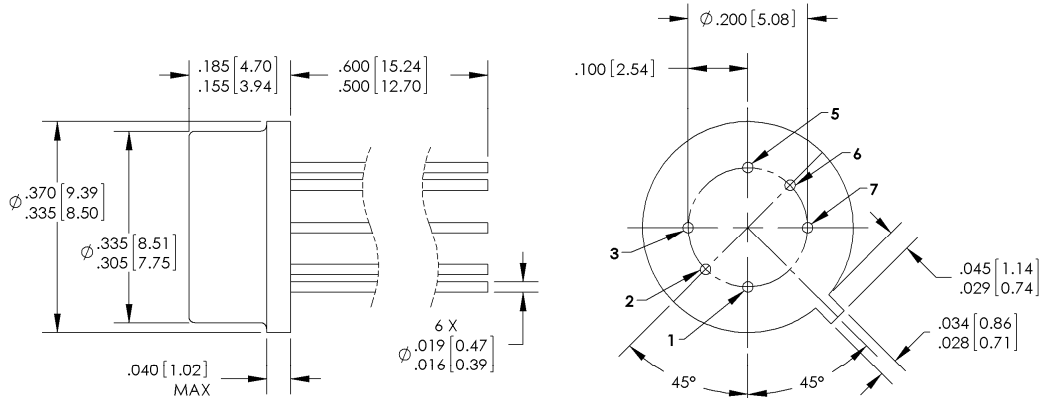

DIMENSIONS ARE IN INCHES [MM]

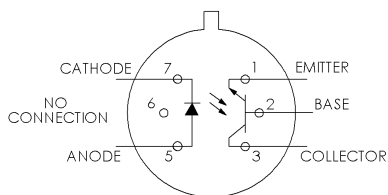

**BOTTOM VIEW**

Pin #	Function	Pin #	Function
3	Collector	5	Anode
2	Base	6	Open
1	Emitter	7	Cathode

This product is built, tested and shipped from the USA

OPTEK reserves the right to make changes at any time in order to improve design and to supply the best product possible.

# Hi-Reliability Optically Coupled Isolator

## JAN / JANTX / JANTXV 4N22, 4N23, 4N24 [A]



### Absolute Maximum Ratings ( $T_A = 25^\circ\text{C}$ unless otherwise noted)

Storage Temperature Range	-65° C to +150° C
Operating Temperature Range	-55° C to +125° C
Input-to-Output Isolation Voltage	$\pm 1.00\text{ kVDC}^{(1)}$
Lead Soldering Temperature [1/16 inch (1.6 mm) from case for 5 seconds with soldering iron]	260° C <sup>(2)</sup>
ESD Class	1C

### Input Diode

Forward DC Current (65° C or below)	40 mA
Reverse Voltage	2 V
Peak Forward Current (1 $\mu\text{s}$ pulse width, 300 pps)	1 A
Power Dissipation	60 mW <sup>(3)</sup>

### Output Sensor:

Continuous Collector Current	50 mA
Collector-Emitter Voltage	40 V
Collector-Base Voltage	45 V
Emitter-Base Voltage	4 V
Power Dissipation	300 mW <sup>(4)</sup>

### Notes:

1. Measured with input leads shorted together and output leads shorted together.
2. RMA flux is recommended. Duration can be extended to 10 seconds maximum when flow soldering.
3. Derate linearly 1.0 mW/° C above 65° C.
4. Derate linearly 3.0 mW/° C above 25° C.

Ordering Information				
Part Number	Isolation Voltage (kV)	I <sub>F</sub> (mA) Typ / Max	V <sub>CE</sub> (Volts) Max	Processing MIL-PRF-195000
JAN4N22 or JAN4N22A	1	10 / 40	40	486
JANTX4N22 or JANTX4N22A				
JANTXV4N22 or JANTXV4N22A				
JAN4N23 or JAN4N23A				
JANTX4N23 or JANTX4N23A				
JANTXV4N23 or JANTXV4N23A				
JAN4N24 or JAN4N24A				
JANTX4N24 or JANTX4N24A				
JANTXV4N24 or JANTXV4N24A				

This product is built, tested and shipped from the USA



OPTEK reserves the right to make changes at any time in order to improve design and to supply the best product possible.

# Hi-Reliability Optically Coupled Isolator

## JAN / JANTX / JANTXV 4N22, 4N23, 4N24 [A]



### Electrical Characteristics ( $T_A = 25^\circ\text{C}$ unless otherwise noted)

SYMBOL	PARAMETER	MIN	TYP	MAX	UNITS	TEST CONDITIONS
--------	-----------	-----	-----	-----	-------	-----------------

#### Output Diode

$V_F$	Forward Voltage	0.80 1.00 0.70	- - -	1.50 1.70 1.30	V	$I_F = 10.0\text{ mA}$ $I_F = 10.0\text{ mA}, T_A = -55^\circ\text{C}^{(1)}$ $I_F = 10.0\text{ mA}, T_A = +100^\circ\text{C}^{(1)}$
$I_R$	Reverse Current	-	-	100	$\mu\text{A}$	$V_R = 2.0\text{ V}$

#### Output Phototransistor

$V_{(BR)CEO}$	Collector-Emitter Breakdown Voltage	40	-	-	V	$I_C = 1.0\text{ mA}, I_B = 0, I_F = 0$
$V_{(BR)CBO}$	Collector-Base Breakdown Voltage	45	-	-	V	$I_C = 100\ \mu\text{A}, I_B = 0, I_F = 0$
$V_{(BR)EBO}$	Emitter-Base Breakdown Voltage	7	-	-	V	$I_E = 100\ \mu\text{A}, I_C = 0, I_F = 0$
$I_{C(OFF)}$	Collector-Emitter Dark Current	-	-	100 100	nA $\mu\text{A}$	$V_{CE} = 20\text{ V}, I_B = 0, I_F = 0$ $V_{CE} = 20\text{ V}, I_B = 0, I_F = 0, T_A = 100^\circ\text{C}$
$I_{CB(OFF)}$	Collector-Base Dark Current	-	-	100	nA	$V_{CB} = 20\text{ V}, I_E = 0, I_F = 0$

#### Coupled

$I_{C(ON)}$	On-State Collector Current JAN / JANTX / JANTXV 4N22 [A]	0.15 2.50 1.00 1.00	- - - -	- - - -	mA	$I_F = 2.0\text{ mA}, V_{CE} = 5\text{ V}, I_B = 0$ $I_F = 10.0\text{ mA}, V_{CE} = 5\text{ V}, I_B = 0$ $I_F = 10.0\text{ mA}, V_{CE} = 5\text{ V}, I_B = 0, T_A = -55^\circ\text{C}^{(1)}$ $I_F = 10.0\text{ mA}, V_{CE} = 5\text{ V}, I_B = 0, T_A = 100^\circ\text{C}^{(1)}$
	JAN / JANTX / JANTXV 4N23 [A]	0.20 6.00 2.50 2.50	- - - -	- - - -		$I_F = 2.0\text{ mA}, V_{CE} = 5\text{ V}, I_B = 0$ $I_F = 10.0\text{ mA}, V_{CE} = 5\text{ V}, I_B = 0$ $I_F = 10.0\text{ mA}, V_{CE} = 5\text{ V}, I_B = 0, T_A = -55^\circ\text{C}^{(1)}$ $I_F = 10.0\text{ mA}, V_{CE} = 5\text{ V}, I_B = 0, T_A = 100^\circ\text{C}^{(1)}$
	JAN / JANTX / JANTXV 4N24 [A]	0.40 10.0 4.00 4.00	- - - -	- - - -		$I_F = 2.0\text{ mA}, V_{CE} = 5\text{ V}, I_B = 0$ $I_F = 10.0\text{ mA}, V_{CE} = 5\text{ V}, I_B = 0$ $I_F = 10.0\text{ mA}, V_{CE} = 5\text{ V}, I_B = 0, T_A = -55^\circ\text{C}^{(1)}$ $I_F = 10.0\text{ mA}, V_{CE} = 5\text{ V}, I_B = 0, T_A = 100^\circ\text{C}^{(1)}$
$V_{CE(SAT)}$	Collector-Emitter Saturation Voltage JAN / JANTX / JANTXV 4N22 [A]	-	-	0.30	V	$I_F = 20\text{ mA}, I_C = 2.5\text{ mA}, I_B = 0$
	JAN / JANTX / JANTXV 4N23 [A]	-	-	0.30		$I_F = 20\text{ mA}, I_C = 5.0\text{ mA}, I_B = 0$
	JAN / JANTX / JANTXV 4N24 [A]	-	-	0.30		$I_F = 20\text{ mA}, I_C = 10.0\text{ mA}, I_B = 0$
$H_{FE}$	DC Current Gain	100	-	-	V	$V_{CE} = 5.0\text{ V}, I_C = 10.0\text{ mA}, I_F = 0\text{ mA}$
$R_{IO}$	Resistance (Input-to-Output)	$10^{11}$	-	-	$\Omega$	$V_{IO} = \pm 1.0\text{ VDC}^{(3)}$
$C_{IO}$	Capacitance (Input-to-Output)	-	-	5	pF	$V_{IO} = 0\text{ V}, f = 1.0\text{ MHz}^{(3)}$
$T_R, T_F$	Output Rise and Fall Time	-	-	20.0	$\mu\text{s}$	$V_{CC} = 10.0\text{ V}, I_F = 10.0\text{ mA}, R_L = 100\ \Omega$

#### Notes:

1. Guaranteed but not tested.
2. Sample tested, LTPD = 10.
3. Measured with input leads shorted together and output leads shorted together.

This product is built, tested and shipped from the USA



OPTEK reserves the right to make changes at any time in order to improve design and to supply the best product possible.

Typical Performance Curves

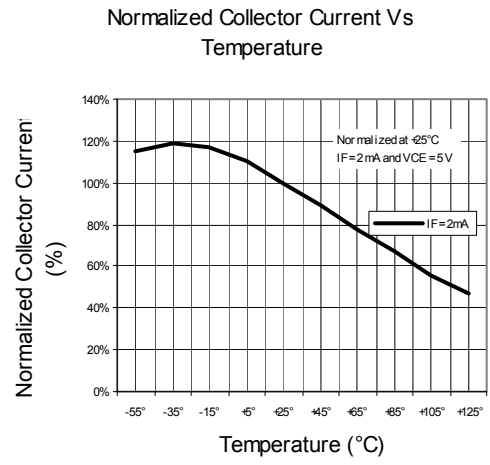
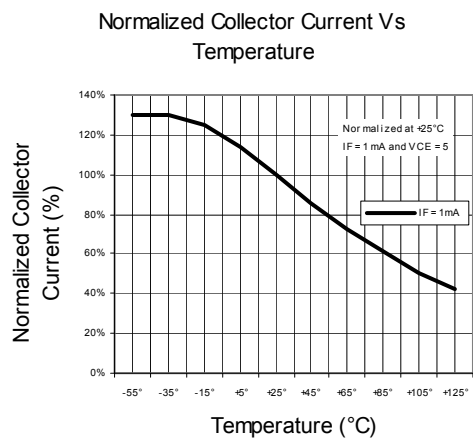
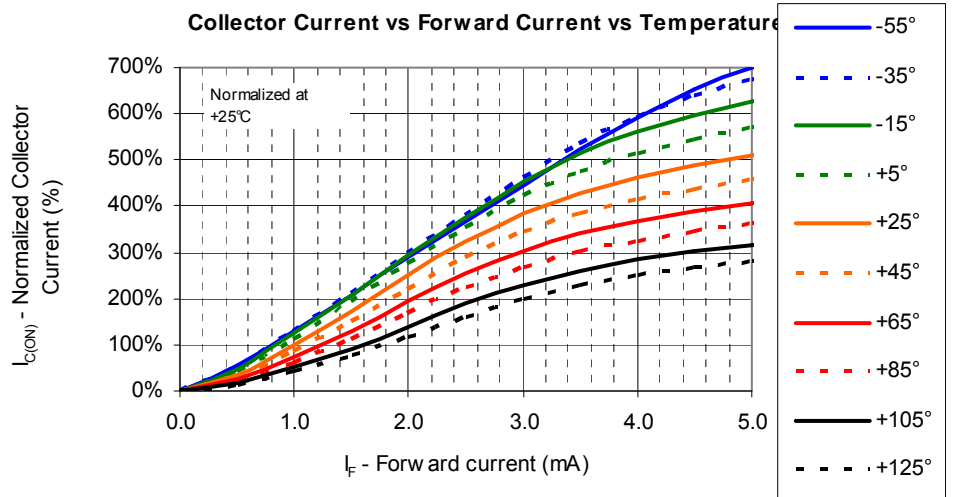
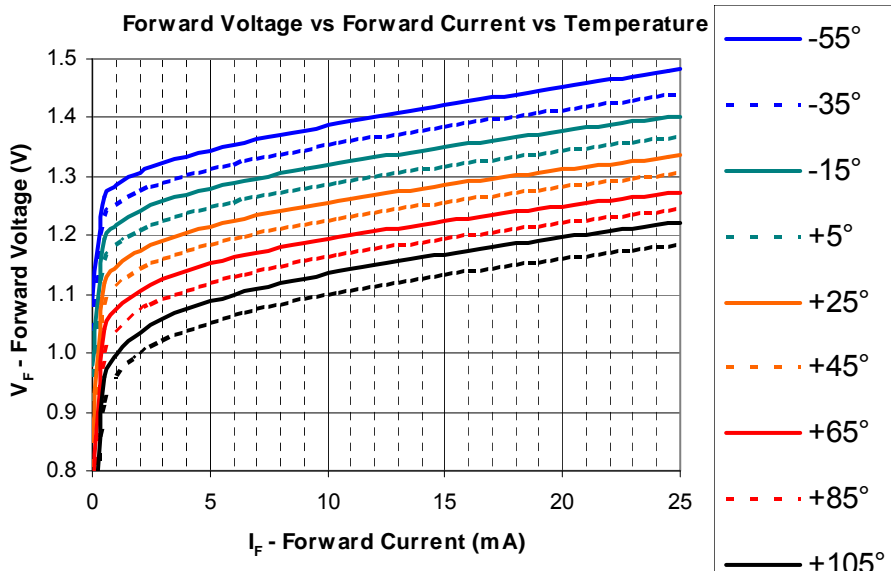

This product is built, tested and shipped from the USA 

OPTEK reserves the right to make changes at any time in order to improve design and to supply the best product possible.

# Mouser Electronics

Authorized Distributor

Click to View Pricing, Inventory, Delivery & Lifecycle Information:

## TT Electronics:

[JANTX4N23U](#) [JAN4N22U](#) [JANTX4N22U](#) [JANTX4N24U](#) [JANTXV4N24U](#) [JAN4N24U](#) [JAN4N23U](#) [JANTXV4N22U](#)  
[JANTXV4N23U](#)