

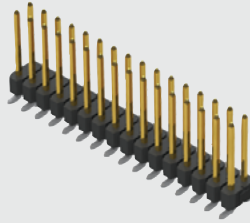

(2.54 mm) .100"

TSM-116-02-S-DV-LC



TSM-121-01-T-SV

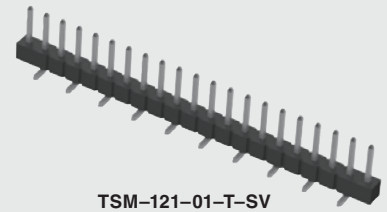

SMT .025" SQ POST HEADER

Board Mates:

SSW, SSQ, SSM, BSW, ESW, ESQ, BCS, SLW, CES, HLE

Cable Mates:

IDSS, IDSD

SPECIFICATIONS

For complete specifications and recommended PCB layouts see www.samtec.com?TSM

Insulator Material:

Black Liquid Crystal Polymer

Terminal Material:

Phosphor Bronze

Plating:

Au or Sn over 50 μm (1.27 μm) Ni

Operating Temp Range:

-55 °C to +105 °C with Tin;

-55 °C to +125 °C with Gold

Voltage Rating:

475 VAC -SV/-DV mated with BCS or SSM

RoHS Compliant: Yes

MATES	CURRENT RATING (PER PIN)
TSM/SSW	4.7 A
TSM/SSM	5.4 A
TSM/HLE	4.1 A
2 PINS POWERED	

PROCESSING

Lead-Free Solderable: Yes

-DH/-SH Lead Coplanarity: (0.15 mm) .006" max (02-36)*

-DV/-SV Lead Coplanarity: (0.10 mm) .004" max (02-05)

(0.13 mm) .005" max (06-10)*

(0.15 mm) .006" max (11-36)*

*(.004" stencil solution may be available; contact IPG@samtec.com)

RECOGNITIONS

For complete scope of recognitions see www.samtec.com/quality



ALSO AVAILABLE (MOQ Required)

- Edge Mount and Locking Clips for -SV
- Solder Locks for -DH and Shrouds for -DV
- Other platings

Note: Some lengths, styles and options are non-standard, non-returnable.

TSM	1	NO. PINS PER ROW	LEAD STYLE	PLATING OPTION	ROW OPTION
		02 thru 36		-F = Gold flash on post, Matte Tin on tail	
				-L = 10 μm (0.25 μm) Gold on post, Matte Tin on tail	
				-S = 30 μm (0.76 μm) Gold on post, Matte Tin on tail	
				-T = Matte Tin	

-SV
= Single Row Vertical Pin

-SH
= Single Row Horizontal Pin

Due to technical progress, all designs, specifications and components are subject to change without notice.

WWW.SAMTEC.COM

All parts within this catalog are built to Samtec's specifications.

Customer specific requirements must be approved by Samtec and identified in a Samtec customer-specific drawing to apply.

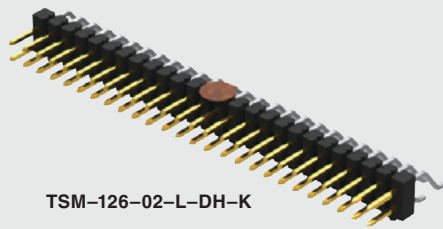

TSM-126-02-L-DH-K

TSM-115-01-T-SH-A

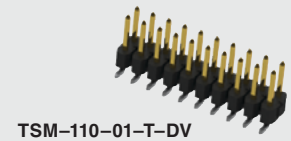
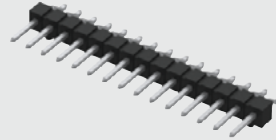

TSM-110-01-T-DV

TSM SERIES

OTHER OPTIONS

-A

= Alignment Pin metal or plastic at Samtec discretion (Not available with -TM or -MT) (02 positions min.) (Not available with -LC)

-LC

= Locking Clip (Not available with -TM) (3 positions min.) (Not available with -A) (Manual placement required)

-K

= (6.50 mm) .256" DIA Polyimide Film Pick & Place Pad (-SH: 4 positions minimum without -TR; 2 & 3 positions available with -TR) (-DH: 4 positions minimum without -TR)

-“XXX”
= Polarized Position

-P

= Plastic Pick & Place Pad (-DV: 4 positions minimum without -TR; 2 & 3 positions available with -TR) (-SH: 4 positions minimum without -TR; 2 & 3 positions available with -TR) (-DH: 5 positions minimum without -TR) (-SV: 4 positions minimum without -TR; 2 & 3 positions available with -TR)

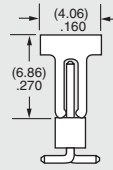

-SV

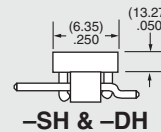

-SH & -DH

-TR

= Tape & Reel Packaging -SV = 02-22 positions -DV = 02-28 positions -SH = 02-30 positions -DH = 02-29 positions Not available with -MT or -TM

-DV

= Double Row Vertical Pin

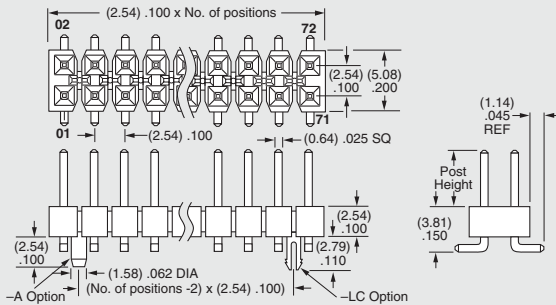

-TM

= Triple Row Vertical Mixed Technology (Style -01 only)

02 thru 30 positions only

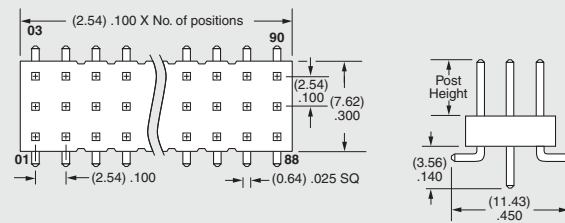

-DH

= Double Row Horizontal Pin (Style -01, -02 or -03 only)

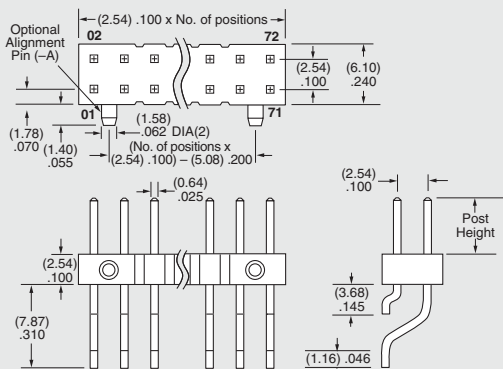

-MT

= Mixed Technology Pin (Style -01, -02 or -03 only)

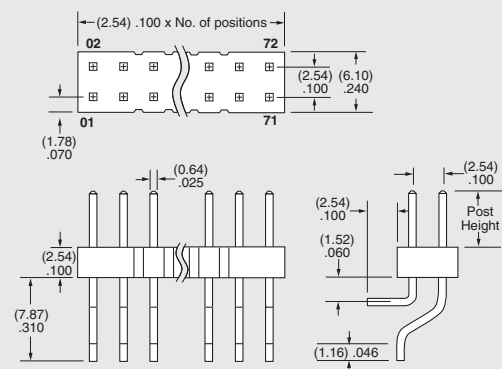

Due to technical progress, all designs, specifications and components are subject to change without notice.

WWW.SAMTEC.COM

All parts within this catalog are built to Samtec's specifications. Customer specific requirements must be approved by Samtec and identified in a Samtec customer-specific drawing to apply.

Mouser Electronics

Authorized Distributor

Click to View Pricing, Inventory, Delivery & Lifecycle Information:

[Samtec:](#)

[TSM-122-01-L-SV](#)