



## Multi-Port Modular Jacks

### Product Facts

- Meets or exceeds FCC Part 68 rules and regulations with standard pc board footprints
- Low profile and narrow width allow more ports to be packed into less space
- Unshielded and shielded versions in popular size configurations
- Positive connection throughout life of equipment with insert molded contacts
- Accurately positioned solder tails reduce assembly labor while selectively deposited gold plating results in lower cost
- Center mounting leg available on 8 port shielded and unshielded versions
- Available with two grounding paths; pc board & panel
- Listed by Underwriters Laboratories Inc., File No. E81956 
- Certified by Canadian Standards Association, File No. LR 7189A 
- Produced under a Quality Management System Certified to ISO 9001  
A copy of the certificate is available upon request

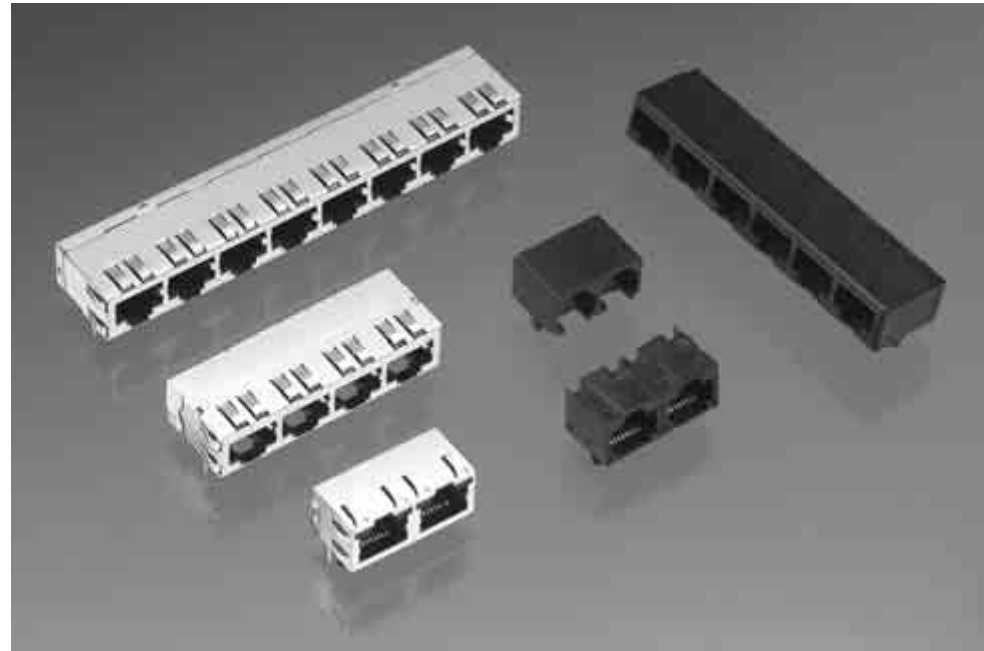

### Specifications

#### Electrical

**Current Rating** — 1.5 amp max. @ 25°C

**Voltage Rating** — 150 VAC max. Contact to Contact

**Dielectric Withstanding Voltage** — 1000 VAC

**Insulation Resistance** — 500 megaohms min.

**Shielding Effectiveness** — 20dB min., 10 to 200 MHz

#### Mechanical

**Durability** — 750 mating cycles

**Mating/Unmating Forces** — 5 lbs. max.

**Operating Temperature** — 40°C to 70°C

### Material and Finish

**Housing** — High temperature nylon, black UL 94V-0 rated

**Contact** — .013 [0.33] Phosphor bronze; plated .000050 [0.00127] gold in localized area and .000150 [0.00381] tin-lead on solder tails, over .000050 [0.00127] nickel underplate

**Shield** — .010 [0.25] or .0077 [0.20] copper alloy tin-lead plated

### Technical Documents

**Application Specifications**  
114-02048

**Product Specifications**  
108-01163

**Multi-Port Modular Jacks** (Continued)

**Side Entry (RA), Thru-Hole**

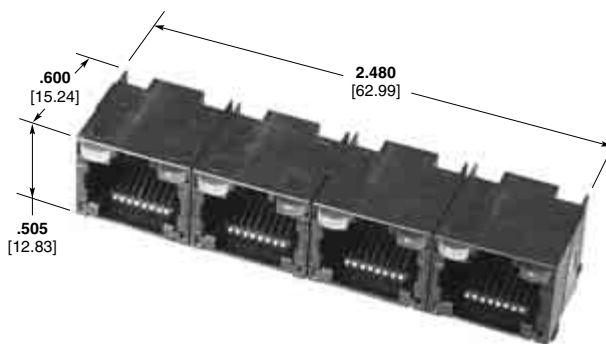

**Multi-Port  
Unshielded**

No. of Ports	Part Number	Positions/Contacts	LEDs	Shielded	Performance	Panel Stops	Inverted	Ground Options
1 x 2	3-1734479-3	6/6	Without	No	Cat 3	Without	Yes	Without
1 x 2	5406542-1	6/6	Without	No	Cat 3	Without	Yes	Without
1 x 2	5406443-1	8/8	Without	Yes	Cat 5	Without	No	PCB Ground
1 x 2	5557560-1	8/8	Without	No	Cat 4	Without	No	Without
1 x 2	6116353-1	8/8	With	Yes	Cat 5	Without	Yes	Panel and PCB
1 x 2	6368419-1	8/8	With	Yes	Cat 5	Without	Yes	Panel and PCB
1 x 4	1734714-2	8/8	Without	Yes	Cat 3	Without	No	Panel and PCB
1 x 4	5406203-3	8/8	Without	Yes	Cat 5	Without	No	Panel and PCB
1 x 4	5406281-3	8/8	Without	Yes	Cat 5	Without	No	Panel and PCB
1 x 4	5557562-1	8/8	Without	No	Cat 4	Without	No	Without
1 x 4	5558503-1	8/8	Without	Yes	Cat 5	Without	No	PCB Ground
1 x 4	5406536-4	8/8	With	No	Cat 5	Without	Yes	Without
1 x 4	5406552-1	8/8	With	Yes	Cat 5	Without	Yes	Panel and PCB
1 x 4	5406552-4	8/8	With	Yes	Cat 5	Without	Yes	Panel and PCB
1 x 6	5406206-1	8/8	Without	Yes	Cat 5	Without	No	Panel and PCB
1 x 8	5558505-1	8/8	Without	Yes	Cat 5	Without	No	PCB Ground

**Side Entry (RA), Thru-Hole  
(Combination RJ11/RJ45)**

No. of Ports	Part Number	Positions/Contacts	LEDs	Shielded	Performance	Panel Stops	Inverted	Ground Options
1 x 2	2-1734712-2	6/2	With	Yes	Cat 3	Without	Yes	PCB Ground

**Note:** All part numbers are RoHS compliant.

**Multi-Port Modular Jacks** (Continued)

**Side Entry (RA), Surface Mount**

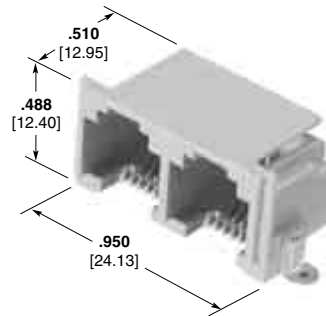

Part Number 406903-1

No. of Ports	Part Number	Positions/Contacts	LEDs	Shielded	Performance	Panel Stops	Inverted	Ground Options
1 x 2	5406903-1	6/6	Without	No	Cat 3	Without	Yes	Without
1 x 2	5406903-2	6/6	Without	No	Cat 3	Without	Yes	Without

Multi-Port Modular Jacks

**Top Entry, Thru-Hole**

No. of Ports	Part Number	Positions/Contacts	LEDs	Shielded	Performance	Panel Stops	Inverted	Ground Options
1 x 6	569748-1	8/8	Without	No	Cat 5	Without	No	Without

**Shorting**

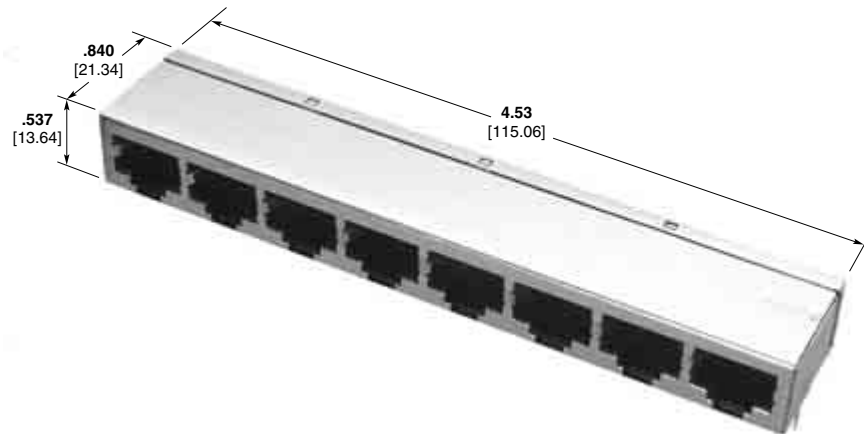

No. of Ports	Positions/Contacts	Shorting Configuration	Panel Grounds	Tray Packaging Part Numbers
1 x 8	8/8	1-4 & 2-5	RJ 48X	5558846-1

**NOTE:** SHIELDED PRODUCT WITH PANEL GROUNDS ALWAYS CONTAINS PCB GROUNDS

**Note:** All part numbers are RoHS compliant.

# Mouser Electronics

Authorized Distributor

Click to View Pricing, Inventory, Delivery & Lifecycle Information:

[TE Connectivity:](#)

[5558505-1](#)