

# TLI4970-D050T4

High precision miniature coreless magnetic current sensor for AC and DC measurements with digital interface and fast overcurrent detection

## Data Sheet

Rev. 1.1, 2016-06-17

**Edition 2016-06-17**

**Published by  
Infineon Technologies AG  
81726 Munich, Germany**

**© 2016 Infineon Technologies AG  
All Rights Reserved.**

### **Legal Disclaimer**

The information given in this document shall in no event be regarded as a guarantee of conditions or characteristics. With respect to any examples or hints given herein, any typical values stated herein and/or any information regarding the application of the device, Infineon Technologies hereby disclaims any and all warranties and liabilities of any kind, including without limitation, warranties of non-infringement of intellectual property rights of any third party.

### **Information**

For further information on technology, delivery terms and conditions and prices, please contact the nearest Infineon Technologies Office ([www.infineon.com](http://www.infineon.com)).

### **Warnings**

Due to technical requirements, components may contain dangerous substances. For information on the types in question, please contact the nearest Infineon Technologies Office.

Infineon Technologies components may be used in life-support devices or systems only with the express written approval of Infineon Technologies, if a failure of such components can reasonably be expected to cause the failure of that life-support device or system or to affect the safety or effectiveness of that device or system. Life support devices or systems are intended to be implanted in the human body or to support and/or maintain and sustain and/or protect human life. If they fail, it is reasonable to assume that the health of the user or other persons may be endangered.

**Revision History**

Page or Item	Subjects (major changes since previous revision)
<b>Rev. 1.1, 2016-06-17</b>	
<b>Page 21</b>	<b>Chapter 3.6</b> added.
<b>Page 12</b>	Added note on default bandwidth.
<b>Page 18</b>	<b>Table 3-4 “OCD Output Parameter” on Page 18</b> updated: Added row for De-glitch filter time. Added note on default OCD level.

**Trademarks of Infineon Technologies AG**

AURIX™, C166™, CanPAK™, CIPOS™, CIPURSE™, EconoPACK™, CoolMOS™, CoolSET™, CORECONTROL™, CROSSAVE™, DAVE™, EasyPIM™, EconoBRIDGE™, EconoDUAL™, EconoPIM™, EiceDRIVER™, eupec™, FCOS™, HITFET™, HybridPACK™, I<sup>2</sup>RF™, ISOFACE™, IsoPACK™, MIPAQ™, ModSTACK™, my-d™, NovalithIC™, OptiMOS™, ORIGA™, PRIMARION™, PrimePACK™, PrimeSTACK™, PRO-SIL™, PROFET™, RASIC™, ReverSave™, SatRIC™, SIEGET™, SINDRION™, SIPMOS™, SmartLEWIS™, SOLID FLASH™, TEMPFET™, thinQ!™, TRENCHSTOP™, TriCore™.

**Other Trademarks**

Advance Design System™ (ADS) of Agilent Technologies, AMBA™, ARM™, MULTI-ICE™, KEIL™, PRIMECELL™, REALVIEW™, THUMB™, μVision™ of ARM Limited, UK. AUTOSAR™ is licensed by AUTOSAR development partnership. Bluetooth™ of Bluetooth SIG Inc. CAT-iq™ of DECT Forum. COLOSSUS™, FirstGPS™ of Trimble Navigation Ltd. EMV™ of EMVCo, LLC (Visa Holdings Inc.). EPCOS™ of Epcos AG. FLEXGO™ of Microsoft Corporation. FlexRay™ is licensed by FlexRay Consortium. HYPERTERMINAL™ of Hilgraeve Incorporated. IEC™ of Commission Electrotechnique Internationale. IrDA™ of Infrared Data Association Corporation. ISO™ of INTERNATIONAL ORGANIZATION FOR STANDARDIZATION. MATLAB™ of MathWorks, Inc. MAXIM™ of Maxim Integrated Products, Inc. MICROTEC™, NUCLEUS™ of Mentor Graphics Corporation. Mifare™ of NXP. MIPI™ of MIPI Alliance, Inc. MIPS™ of MIPS Technologies, Inc., USA. muRata™ of MURATA MANUFACTURING CO., MICROWAVE OFFICE™ (MWO) of Applied Wave Research Inc., OmniVision™ of OmniVision Technologies, Inc. Openwave™ Openwave Systems Inc. RED HAT™ Red Hat, Inc. RFMD™ RF Micro Devices, Inc. SIRIUS™ of Sirius Satellite Radio Inc. SOLARIS™ of Sun Microsystems, Inc. SPANSION™ of Spansion LLC Ltd. Symbian™ of Symbian Software Limited. TAIYO YUDEN™ of Taiyo Yuden Co. TEAKLITE™ of CEVA, Inc. TEKTRONIX™ of Tektronix Inc. TOKO™ of TOKO KABUSHIKI KAISHA TA. UNIX™ of X/Open Company Limited. VERILOG™, PALLADIUM™ of Cadence Design Systems, Inc. VLYNQ™ of Texas Instruments Incorporated. VXWORKS™, WIND RIVER™ of WIND RIVER SYSTEMS, INC. ZETEX™ of Diodes Zetex Limited.

Last Trademarks Update 2011-02-24

## Table of Contents

	<b>Table of Contents</b> .....	4
	<b>List of Figures</b> .....	5
	<b>List of Tables</b> .....	6
<b>1</b>	<b>Product Description</b> .....	7
1.1	Overview .....	7
1.2	Features .....	7
1.3	General Information .....	8
1.4	Target Applications .....	8
<b>2</b>	<b>Functional Description</b> .....	9
2.1	Pin Configuration .....	9
2.2	Block Diagram .....	10
2.3	Functional Description .....	10
2.4	Transfer Function .....	11
2.5	Filter Settings .....	12
2.6	Increased Temperature Range .....	14
<b>3</b>	<b>Specification</b> .....	15
3.1	Absolute Maximum Ratings .....	15
3.2	Operating Conditions .....	15
3.3	Fast Over Current Output .....	18
3.4	Application Circuit .....	19
3.5	Isolation Characteristics .....	20
3.6	CSA Component Acceptance .....	21
3.6.1	Board Description for CSA Component Acceptance Test Conditions .....	21
<b>4</b>	<b>Interfaces</b> .....	23
4.1	SPI Interface Definition .....	23
4.1.1	Logical Interface .....	23
4.1.1.1	Protocol Description .....	23
4.1.1.2	Description of the SPI Data Frames .....	23
4.1.1.3	Sensor Current Message .....	23
4.1.1.4	Sensor Status Message .....	24
4.1.2	Physical SPI Interface .....	25
4.2	Serial Inspection and Configuration Interface (SICI) .....	26
<b>5</b>	<b>Package</b> .....	27
5.1	PG-TISON-8-1 Package Outline .....	27
5.2	Packing .....	28
5.3	Footprint Recommendation .....	29
5.4	PCB Layout Recommendation .....	29
5.5	Laser Marking .....	30

## List of Figures

Figure 1-1	TLI4970-D050T4 device in PG-TISON-8-1 package	7
Figure 2-1	Pin configuration PG-TISON-8-1	9
Figure 2-2	Functional block diagram of the TLI4970-D050T4	10
Figure 2-3	Transfer function formula	11
Figure 2-4	Transfer function	11
Figure 2-5	Bode plots for different filter settings	13
Figure 3-1	Distribution of the maximum total error	17
Figure 3-2	Application circuit for readout of multiple sensors in parallel bus mode	19
Figure 3-3	Test board setting	21
Figure 3-4	Dimension and layout of test board	22
Figure 3-5	Heat sink dimension (in mm)	22
Figure 4-1	SPI interface timing: Readout of sensor data	25
Figure 5-1	PG-TISON-8-1 package dimensions	27
Figure 5-2	Carrier tape of the PG-TISON-8-1 package	28
Figure 5-3	Footprint recommendation for reflow soldering	29
Figure 5-4	PCB layout recommendation	29
Figure 5-5	Laser marking on the top side	30

## List of Tables

Table 1-1	Order Information	7
Table 2-1	Pin Definition and Function	9
Table 2-2	Overview about bandwidth and response time	12
Table 3-1	Absolute Maximum Ratings	15
Table 3-2	Electrical Operating Parameters	15
Table 3-3	Accuracy Parameters	16
Table 3-4	OCD Output Parameter	18
Table 3-5	Typical Application Values	19
Table 3-6	Isolation Parameters according to IEC 60747-5-2	20
Table 3-7	Isolation Parameters according to UL 1577	20
Table 3-8	Absolute maximum ratings according to CSA component acceptance	21
Table 3-9	Test board parameters	21
Table 3-10	Heat sink parameters	22
Table 4-1	Interface Timing Parameters (5MHz SPI clock speed)	26
Table 4-2	Interface Electrical Characteristics (5MHz SPI clock speed)	26

# 1 Product Description



## 1.1 Overview

The TLI4970-D050T4 is a highly accurate coreless magnetic current sensor. Thus, the output signal is highly linear and without hysteresis. However, a differential measurement principle allows effective stray field suppression. Due to the integrated primary conductor (current rail), there is no need for external calibration. Additionally, a separate interface pin (OCD) provides a fast output signal in case a current exceeds a pre-set threshold. A small leadless package (QFN-like) allows for standard SMD assembly.

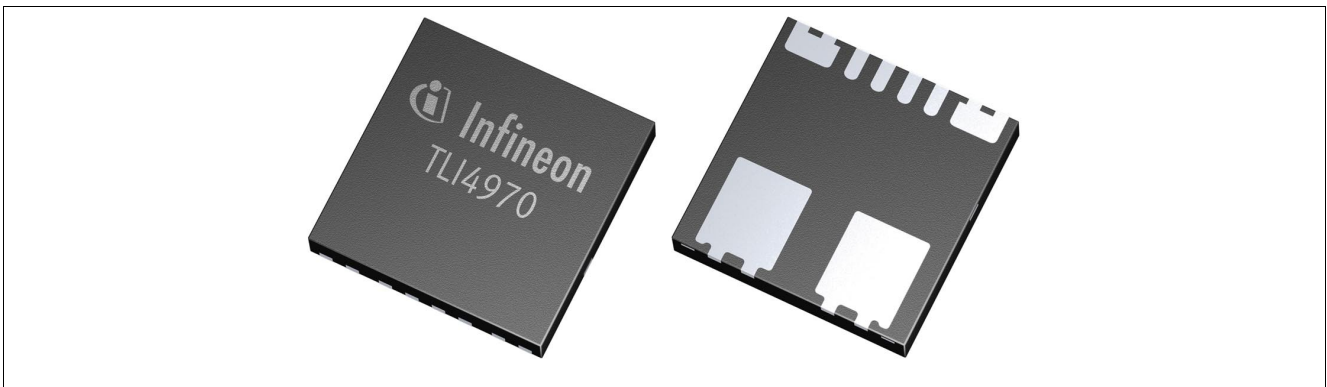

Figure 1-1 TLI4970-D050T4 device in PG-TISON-8-1 package

## 1.2 Features

- AC & DC measurement range up to  $\pm 50$  A
- Highly accurate over temperature range and lifetime  
max. 1.0 % (0 h), 1.6 % (over lifetime) of indicated value
- Low offset error (max. 25 mA at room temperature)
- High magnetic stray field suppression
- Fast over current detection with configurable threshold
- Galvanic isolation up to 2.5 kV max. rated isolation voltage (according to UL 1577)
- 16 bit digital SPI output (13 bit current value)
- Small 7 mm x 7 mm SMD package

Table 1-1 Order Information

Product Name	Product Type	Package	Ordering Number
TLI4970-D050T4	Qualified according to industrial standards: For use in industrial / consumer applications	PG-TISON-8-1	SP000917088

### 1.3 General Information

The TLI4970-D050T4 is a high-precision digital current sensor. The full scale measurement range is  $\pm 50$  A. The sensor is based on Infineon's well-established and robust Hall technology.

The measurement principle allows galvanic isolation (functional isolation) between the primary conductor and the secondary interface side.

The coreless concept without a flux concentrator allows significant miniaturization. It shows no hysteresis effects and has enhanced linearity and over current capability compared to existing solutions. The differential measurement principle achieves best-in-class suppression of magnetic stray fields. The sensor is fully calibrated; no need for any additional calibration after PCB assembly is necessary. Thus, the overall implementation effort and costs are significantly reduced. It is a plug-and-play solution, easy to use in industrial and consumer applications.

The accuracy of the TLI4970-D050T4 is comparable to closed-loop current measurement systems and even better than open-loop systems with magnetic core. But in comparison to the open- and closed-loop system the TLI4970-D050T4 enables a significantly smaller footprint and less power consumption.

Infineon's patented stress compensation circuit provides outstanding long-term stability of the output signal. Proprietary dynamic offset cancellation techniques guarantee particularly low zero point error. Hereby, the TLI4970-D050T4 offers superior performance.

The TLI4970-D050T4 is based on a digital concept. Thus, signal processing, compensation and calibration is already integrated. No further external measurements for compensation are needed.

The sensor is provided in a small 7 mm x 7 mm SMD package.

### 1.4 Target Applications

The TLI4970-D050T4 is suitable for AC as well as DC current measurement applications:

- Current monitoring
- Chargers
- Photovoltaic & general purpose inverters
- Power supplies (SMPS)
- Electrical drive
- etc.

With its implemented magnetic interference suppression, it is extremely robust when exposed to external magnetic fields. It is also suitable for fast over current detection with a configurable threshold level. This allows the control unit to switch off and protect the affected system from damage, independently of the main measurement path.



## 2 Functional Description

### 2.1 Pin Configuration

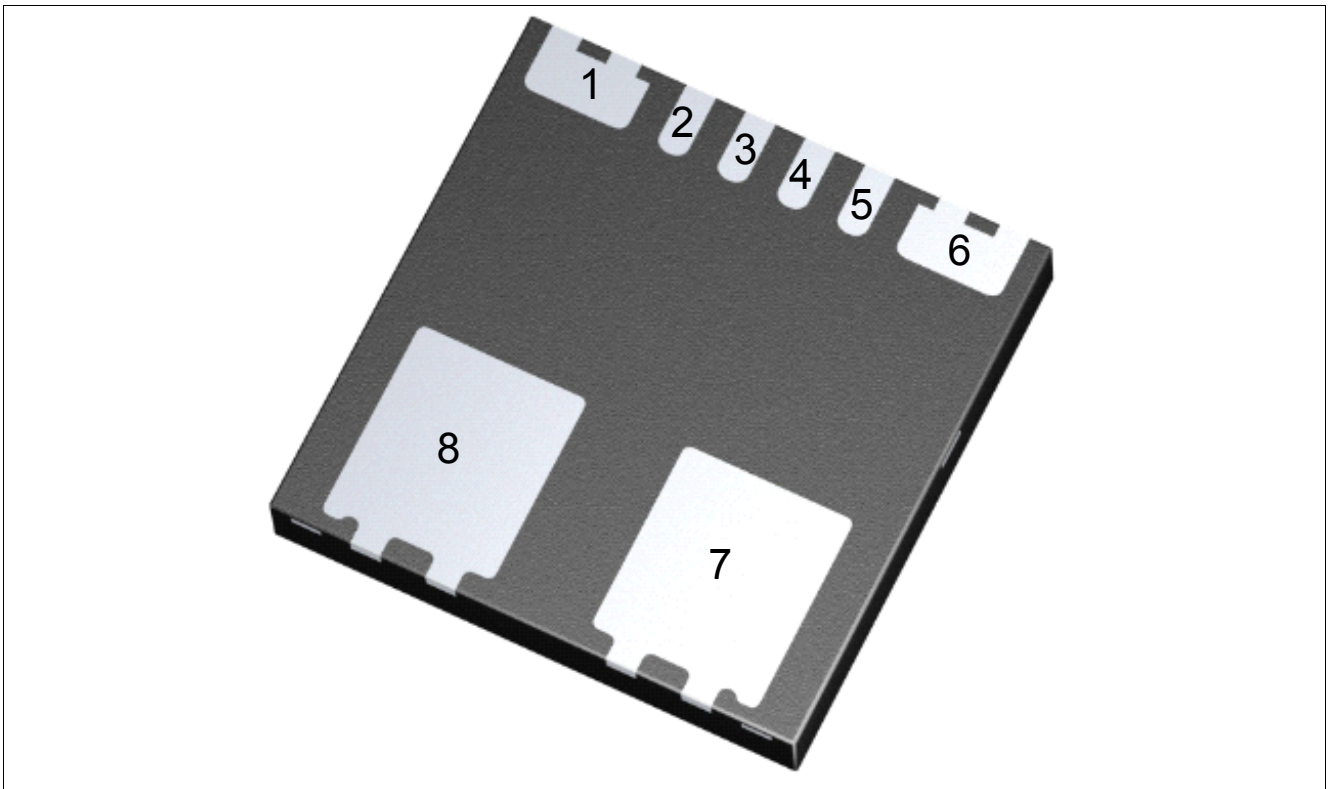

Figure 2-1 Pin configuration PG-TISON-8-1

Table 2-1 Pin Definition and Function

Pin No.	Symbol	Function
1	GND	Ground
2	VDD	Supply voltage
3	DOUT	SPI data out
4	SCLK	Serial clock input
5	$\overline{\text{CS}}$	Chip select input (low-active)
6	OCD	Over current detection output (open drain output)
7	IP+	Positive current terminal pin (current-in)
8	IP-	Negative current terminal pin (current-out)

## 2.2 Block Diagram

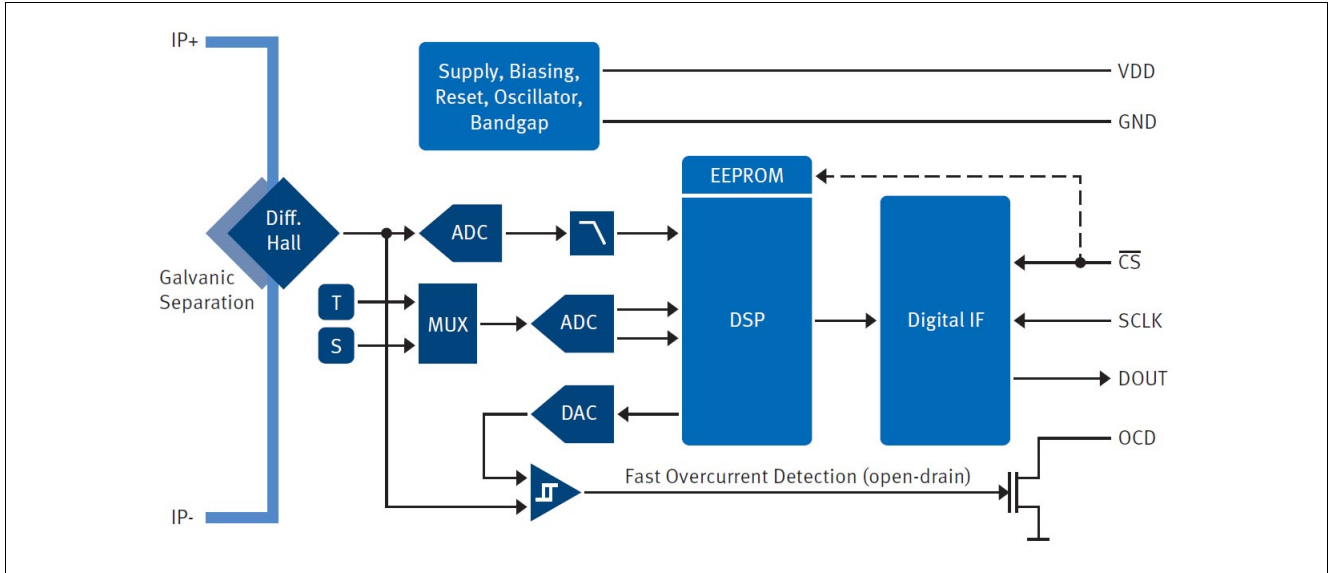

Figure 2-2 Functional block diagram of the TLI4970-D050T4

## 2.3 Functional Description

The current, flowing through the current rail on the primary side, induces a magnetic field. This is measured by two differential Hall probes. The signal from the two Hall probes is directly digitalized by a Sigma-Delta-A/D converter (ADC). After the programmable digital low-pass filter, the raw current signal is fed into the DSP. The differential measurement principle of the magnetic field provides a very good suppression of any ambient magnetic stray fields.

The temperature (T) and the mechanical stress (S) of the chip are measured and converted independently of the primary current by a second ADC. The Digital Signal Processing Unit (DSP) uses both temperature and stress information to compensate the raw current signal according to internally stored calibration tables. The interface unit (IF) transmits the fully compensated value via the SPI interface.

Furthermore several parameters like low pass filter settings or over current detection (OCD) levels can be programmed via a **S**erial **I**nspection and **C**onfiguration Interface (SICI) which are described in the TLI4970 programming guide.

For fast over current detection, the raw analog signal from the Hall probes is fed into a programmable comparator. This comparator has a programmable glitch filter to suppress fast switching transients in the signal and to avoid false triggers. The open-drain output of the OCD-Pin allows readout of over current signals for several TLI4970-D050T4 sensors by only one microcontroller input pin.

## 2.4 Transfer Function

The transfer function is given by the formula shown in [Figure 2-3](#).

$$I_{out}[A] = \frac{out[LSB_D] - 4096[LSB_D]}{80[\frac{LSB_D}{A}]}$$

$$out[LSB_D] = I[A] \cdot 80[\frac{LSB_D}{A}] + 4096[LSB_D]$$

**Figure 2-3** Transfer function formula

The basic point are defined by the value  $0_D$  (-51.200A) and  $8191_D$  (51.1875A). Outside this current range, the sensor status message will be sent instead of the sensor current message (see [Figure 2-4](#)).

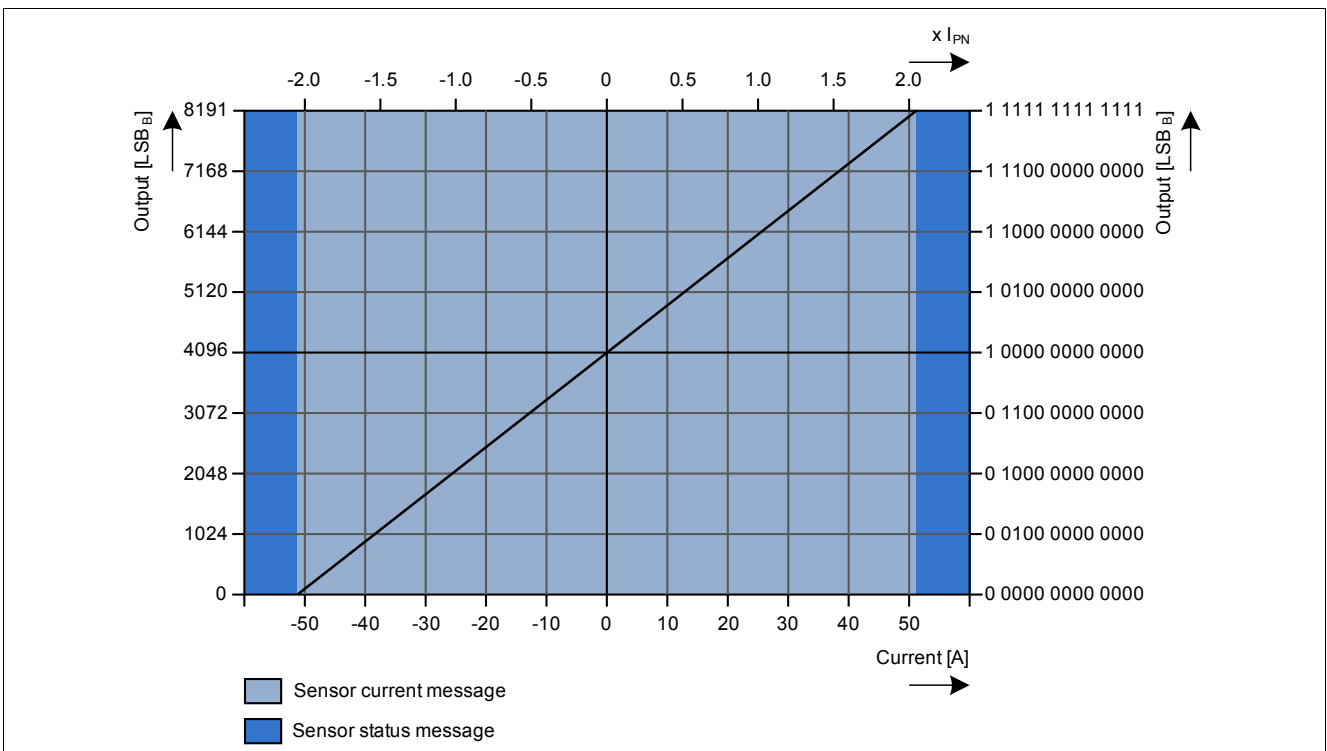

**Figure 2-4** Transfer function

## 2.5 Filter Settings

The transfer function of the TLI4970-D050T4 can be influenced by different filter settings. Finally the combination of a high-pass filter, a prediction filter and a low-pass filter determines the overall transfer function. **Figure 2-5** shows the Bode plots for different filter settings. The filter settings can be changed by EEPROM programming. The manual for EEPROM programming can be found in the TLI4970 programming guide (application note).

**Table 2-2** gives an overview about the different filter settings.

**Table 2-2 Overview about bandwidth and response time**

High-pass filter	Prediction filter	Low-pass filter	Bandwidth	Response time <sup>1)</sup>
1	1	7	70 Hz	6.2 ms
	1	6	130 Hz	3.1 ms
1	1	5	260 Hz	1.6 ms
1	1	4	530 Hz	781 $\mu$ s
1	1	3	1.1 kHz	394 $\mu$ s
1	1	2	2.4 kHz	201 $\mu$ s
1	1	1	5.2 kHz	109 $\mu$ s
1	1	0	6.9 kHz	92 $\mu$ s
0	0	0	10 kHz	70 $\mu$ s
0	1	0	18 kHz	57 $\mu$ s

1) 90% of final value based on 50 A step function

*Note: TLI4970-D050T4 default factory setting is 18 kHz.*

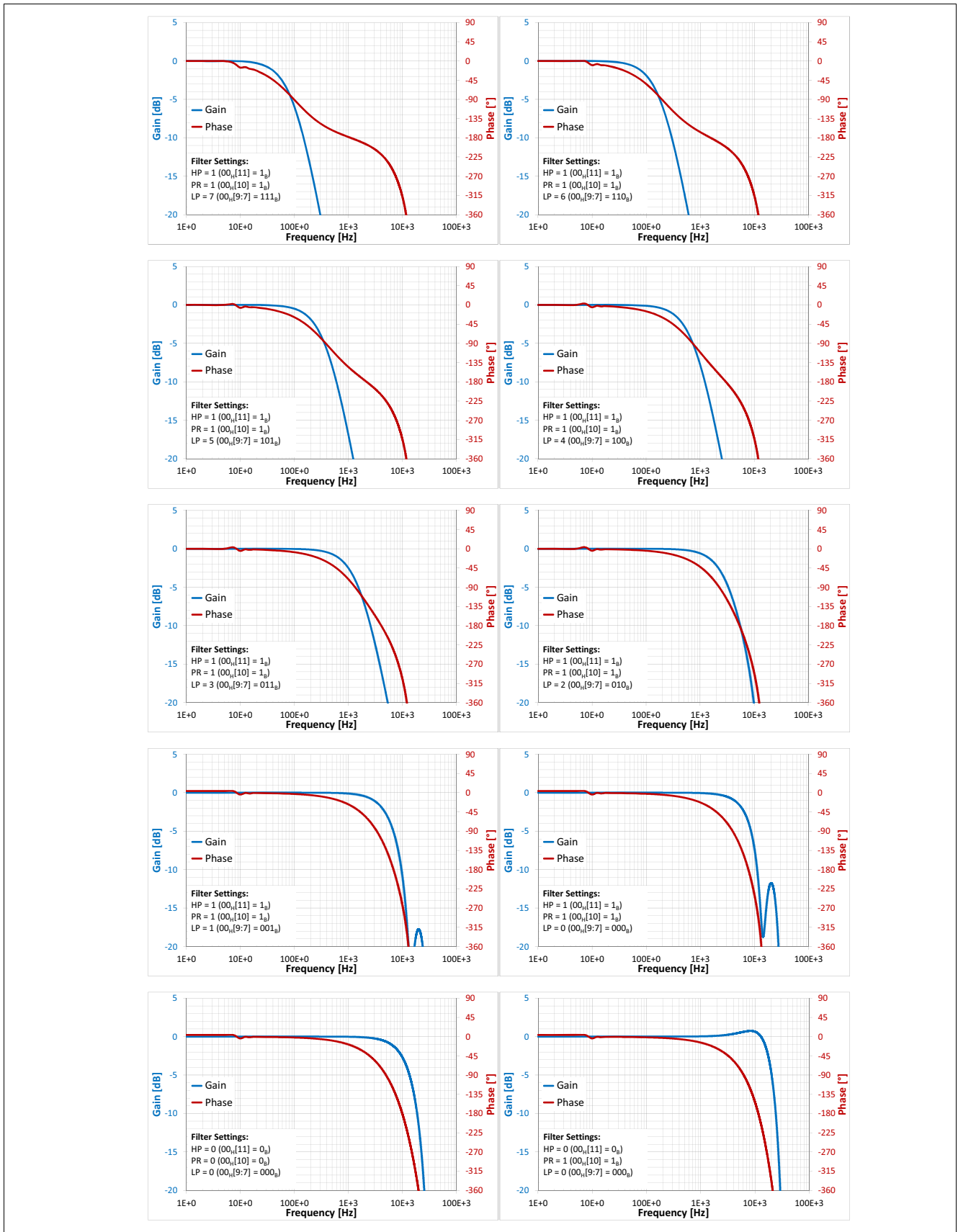

Figure 2-5 Bode plots for different filter settings

## **2.6 Increased Temperature Range**

The max. specified ambient operating temperature of 85°C is limited due to the power dissipation in the current rail. The thermal loss finally increases the junction temperature which has to be limited to 125°C.

Reducing the current through the current rail decreases the thermal loss and therewith a higher ambient operating temperature is possible.

### 3 Specification

#### 3.1 Absolute Maximum Ratings

**Table 3-1 Absolute Maximum Ratings**

 General conditions (unless otherwise specified):  $V_{DD} = 3.3 \text{ V}$ ;  $T_A = -40 \text{ }^\circ\text{C} \dots +85 \text{ }^\circ\text{C}$ 

Parameter	Symbol	Values			Unit	Note / Test Condition
		Min.	Typ.	Max.		
Supply voltage	$V_{DD}$	-0.3	-	+3.6	V	
Maximum primary current	$I_P$	-60	-	+60	A	$T_A = T_{\text{Contact\_IP\_IN}}^{1)}$
Maximum primary pulse current	$I_{P\_PULSE}$	-	-	150	A	Max. 3 pulses, 200 ms each; tested with 105 $\mu\text{m}$ Cu layer on PCB
Voltage on interface pins DOUT, SCLK & OCD	$V_{IO}$	-0.3	-	+3.6	V	
Voltage on interface pin $\overline{\text{CS}}$	$V_{IO\_CS}$	-0.3	-	+21.0	V	
ESD voltage <sup>2)</sup>	$V_{ESD\_HBM}$	-	-	$\pm 2$	kV	
Maximum junction temperature	$T_{J\_max}$	-	-	+125	$^\circ\text{C}$	
Storage temperature	$T_{A\_STORE}$	-40	-	+125	$^\circ\text{C}$	Not connected

 1)  $T_{\text{Contact\_IP\_IN}}$ : Temperature of current rail on PCB at solder joint.

2) According to standard EIA / JESD22-A114-E Human Body Model (HBM)

**Attention: Stresses above the limit values listed here may cause permanent damage to the device. Exposure to absolute maximum rating conditions for extended periods may affect device reliability. Maximum ratings are absolute ratings; exceeding only one of these values may cause irreversible damage to the integrated circuit.**

#### 3.2 Operating Conditions

**Table 3-2 Electrical Operating Parameters**

 General conditions (unless otherwise specified):  $V_{DD} = 3.3 \text{ V}$ ;  $T_A = -40 \text{ }^\circ\text{C} \dots +85 \text{ }^\circ\text{C}$ 

Parameter	Symbol	Values			Unit	Note / Test Condition
		Min.	Typ.	Max.		
Supply voltage	$V_{DD}$	3.1	3.3	+3.5	V	
Voltage on interface pin $\overline{\text{CS}}$	$V_{IO\_CS}$	-0.3	-	+3.6	V	Normal operation
	$V_{IO\_PROG}$	+20.5	-	+20.7	V	Only during programming
Current consumption	$I_{DD}$	5	12	20	mA	Secondary side
Full-scale primary current measurement range	$I_{PFSR}$	-50	-	+50	A	

**Table 3-2 Electrical Operating Parameters (cont'd)**

 General conditions (unless otherwise specified):  $V_{DD} = 3.3\text{ V}$ ;  $T_A = -40\text{ °C} \dots +85\text{ °C}$ 

Parameter	Symbol	Values			Unit	Note / Test Condition
		Min.	Typ.	Max.		
Primary resistance	$R_P$	-	0.6	-	m $\Omega$	Resistance of current rail $T_A = 25\text{ °C}$ $T_{J\_max}$
		-	-	1.0	m $\Omega$	
Ambient temperature	$T_A$	-40	-	+85	°C	$T_A = T_{\text{Contact\_IP\_IN}}^{1)}$

 1)  $T_{\text{Contact\_IP\_IN}}$ : Temperature of current rail on PCB at solder joint.

**Table 3-3 Accuracy Parameters**

 General conditions (unless otherwise specified):  $V_{DD} = 3.3\text{ V}$ ;  $T_A = -40\text{ °C} \dots +85\text{ °C}$ 

Parameter	Symbol	Values			Unit	Note / Test Condition
		Min.	Typ.	Max.		
Relative offset error	$\epsilon_{ROE}$	-0.05	-	+0.05	% of $I_{PFSR}$	@ 0A DC & $T_A = 25\text{ °C}$
		-0.075	-	+0.075	% of $I_{PFSR}$	@ 0A DC & $T_A = -40\text{ °C}$
		-0.15	-	+0.15	% of $I_{PFSR}$	@ 0A DC & $T_A = 85\text{ °C}$
Absolute offset error	$\epsilon_{AOE}$	-25.0	-	+25.0	mA	@ 0A DC & $T_A = 25\text{ °C}$
		-37.5	-	+37.5	mA	@ 0A DC & $T_A = -40\text{ °C}$
		-75.0	-	+75.0	mA	@ 0A DC & $T_A = 85\text{ °C}$
Relative total error (gain, offset, linearity) incl. lifetime-drift and whole temperature range <sup>1)</sup>	$\epsilon_{RTE}$	-1.6	-	+1.6	% of $I_P$	Percentage of indicated value
Absolute total error (gain, offset, linearity) incl. lifetime-drift and whole temperature range <sup>1)</sup>	$\epsilon_{ATE}$	-16.0	-	+16.0	mA/A	Absolute total error proportional to $I_P$
Update rate	$f_{UPDATE}$	-	80	-	kSPS <sup>2)</sup>	
Resolution	$G$	-	12.5	-	mA / LSB	13-Bit current value via SPI
Noise <sup>3)</sup>	$I_{NOISE}$	-	10	-	mA <sub>RMS</sub>	@ $T_A = 25\text{ °C}$ & $BW_I = 1.1\text{ kHz}^{4)}$
Bandwidth of current measurement path	$BW_{I\_min}$	-	70	-	Hz	-3 dB cutoff; see <a href="#">Section 2.5</a> for filter settings
	$BW_{I\_max}$	-	18	-	kHz	
Power-on time		-	-	15	ms	To stable and accurate output data

 1) Valid for soldered parts on PCB based on the footprint recommendation in [Figure 5-3](#) and a copper thickness of 70  $\mu\text{m}$ 

2) kSPS: Thousand samples per second

 3) Characterized in lab for small signals;  $I_P = 0\text{ mA}$ 

4) Bandwidth settings will affect noise



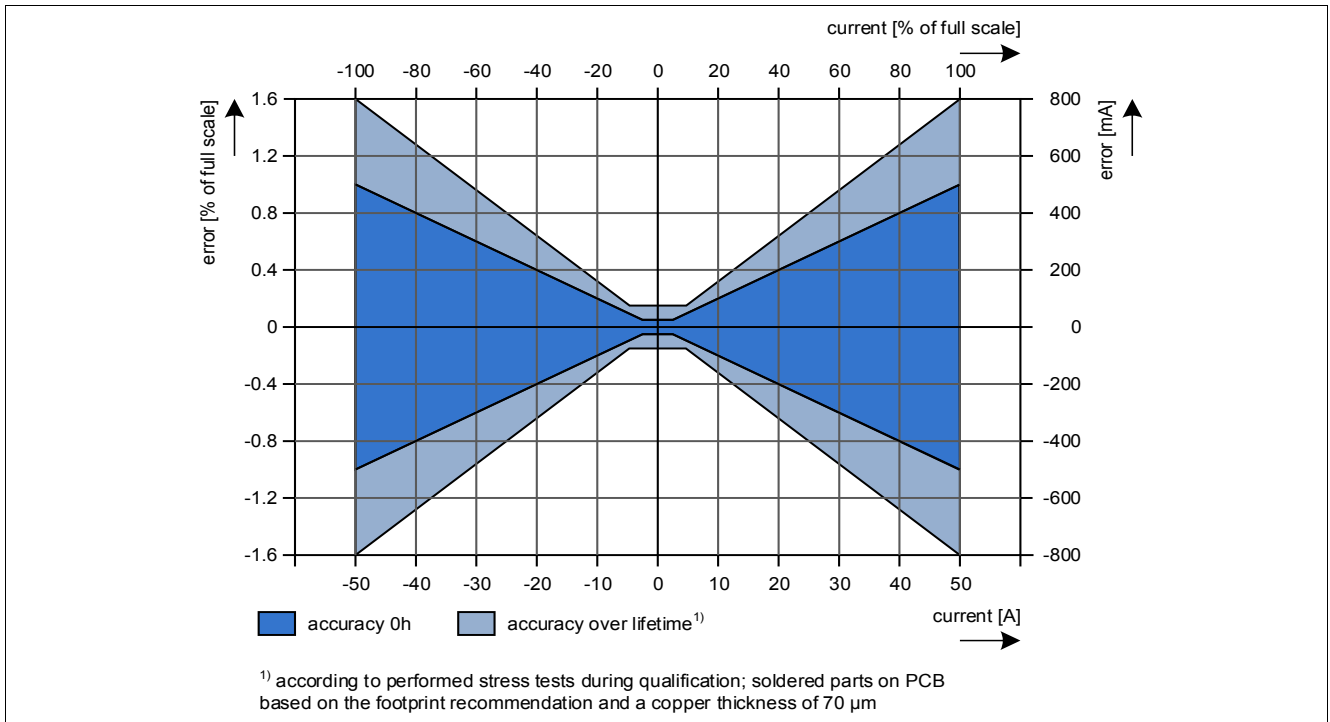

Figure 3-1 Distribution of the maximum total error

### 3.3 Fast Over Current Output

The Fast Over Current (OCD) pin allows fast detection of an over current in the measurement path. The OCD signal path is independent from the bandwidth limited current signal path and has a programmable glitch filter to avoid false triggers by noise spikes on the current rail. The symmetric threshold level of the OCD output is adjustable and triggers an over current event in case of a positive or negative over current.

In addition a zero-crossing functionality can be programmed (in this case the over current detection is disabled).

If connected via an external pull-up resistor to a logic input pin of the microcontroller, it can be used to trigger an interrupt in the microcontroller and quickly shut off the system to avoid damage from the over current event. The OCD pin has an open-drain output that allows monitoring of several current sensors via only one microcontroller input pin. For details, please refer to the application circuit shown in [Figure 3-2](#).

The instruction for the settings can be found in the TLI4970 programming guide.

**Table 3-4 OCD Output Parameter**

General conditions (unless otherwise specified):  $V_{DD} = 3.3 \text{ V}$ ;  $T_A = -40 \text{ °C} \dots +85 \text{ °C}$

Parameter	Symbol	Values			Unit	Note / Test Condition
		Min.	Typ.	Max.		
Threshold level <sup>1)</sup>	$I_{THR}$	3	-	90	A	Programmable (EEPROM). Default factory value 57A.
Accuracy	$X_{OCD}$	-	10	-	% $I_{PFSR}$	
Response time of fast over current detection <sup>2)3)</sup>	$t_{D\_OC}$	-	1.8	3.5	$\mu\text{s}$	Only valid for $\Delta I/\Delta t < 500 \text{ kA/s}$
Load capacitance	$C_L$	-	-	1	nF	To GND
Open-drain current	$I_{OD\_on}$	-	-	1	mA	Resistive to $V_{DD}$ ; $V_{OD\_on} \leq 0.2 \times V_{DD}$
Pull-up resistor	$R_{PU}$	4.7	-	-	k $\Omega$	To $V_{DD}$
De-glitch filter time	$t_{deglitch}$	-	750	-	ns	Default factory value

1) Symmetric threshold level for positive and negative currents

2) Falling edge level of OCD-pin  $< 0,5V_{DD}$

3) Characterized in lab under worst case test conditions:  $R_{PU} = 4.7\text{k}\Omega$  to  $V_{DD}$ ;  $C_L = 1 \text{ nF}$  to GND

### 3.4 Application Circuit

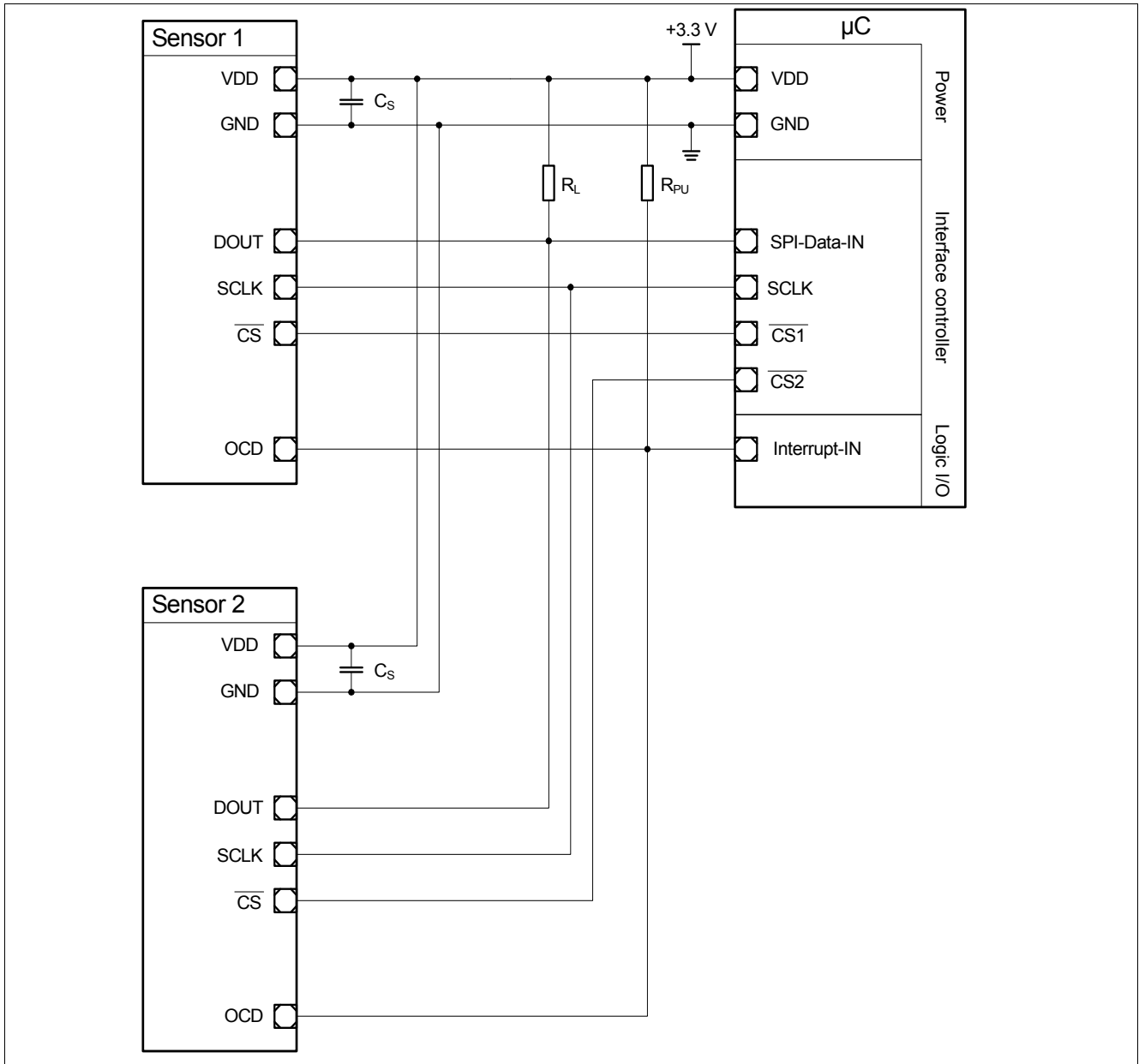

Figure 3-2 Application circuit for readout of multiple sensors in parallel bus mode

Table 3-5 Typical Application Values

Name	Value
$R_{PU}$	47 k $\Omega$
$R_L$	100 k $\Omega$
$C_S$	100 nF

### 3.5 Isolation Characteristics

The TLI4970-D050T4 is qualified and tested according IEC and UL standards (functional isolation).

**Table 3-6 Isolation Parameters according to IEC 60747-5-2**

Description	Symbol	Characteristic	Unit
Maximum rated working voltage (sine wave) <sup>1)2)3)</sup>	$U_{IOWM}$	424	$V_{RMS}$
Maximum repetitive isolation voltage (max. DC-voltage) <sup>1)3)</sup>	$U_{IORM}$	600	$V_{peak}$
Maximum transient over voltage <sup>1)3)</sup>	$U_{IOTM}$	3600	$V_{peak}$
Apparent charge test voltage (Method B) <sup>1)3)</sup> Partial discharge < 5pC	$U_{pd,b}$	900	$V_{peak}$
Isolation test voltage (1 sec) <sup>1)</sup>	$U_{ISO}$	2546	$V_{RMS}$
Maximum surge voltage (1.2 / 50 $\mu$ s) <sup>1)</sup>	$U_{IOSM}$	3600	$V_{peak}$
Minimum external creepage distance	CPG	3.0	mm
Minimum external clearance distance	CLR	3.0	mm
Minimum comparative tracking index	CTI	575 (Material group II)	
Isolation resistance, $U_{IO} = 500 V$ <sup>4)</sup>	$R_{IO}$	$> 10^{10}$	$\Omega$

1) Refer to IEC 60747-5-2 for a detailed description of voltages and partial discharge tests

2) The given value is just an example based on pollution degree 2

3) According to performed stress test (85°C, 85% relative humidity, 1000 h test time & 600 V applied insulation voltage)

4) Not subject to production test - verified by design/characterization

**Table 3-7 Isolation Parameters according to UL 1577**

Description	Symbol	Characteristic	Unit
Maximum rated isolation voltage (1 min.)	$U_{ISO}$	2546	$V_{RMS}$
Isolation test voltage (1 sec)	$U_{ISO}$	2546	$V_{RMS}$

### 3.6 CSA Component Acceptance

The following section describes the test condition for the CSA component acceptance.

**Table 3-8 Absolute maximum ratings according to CSA component acceptance**

Description	Symbol	Characteristic	Unit
Absolute maximum ambient temperature	$T_{A\_CA}$	85	°C
Absolute maximum Isolation voltage <sup>1)</sup>	$U_{ISO\_CA}$	2546	V <sub>RMS</sub>
Absolute maximum current <sup>2)</sup>	$I_{PFSR\_CA}$	50	A <sup>3)</sup>

1) Test conditions: 60 Hz for 60 s

2) Test condition: 4h, the device was mounted on the PCB described below

3) rms or DC

#### 3.6.1 Board Description for CSA Component Acceptance Test Conditions

The device was soldered on a test board described in [Figure 3-4](#) and [Table 3-9](#). Besides, a heat sink was mounted ([Figure 3-3](#)).

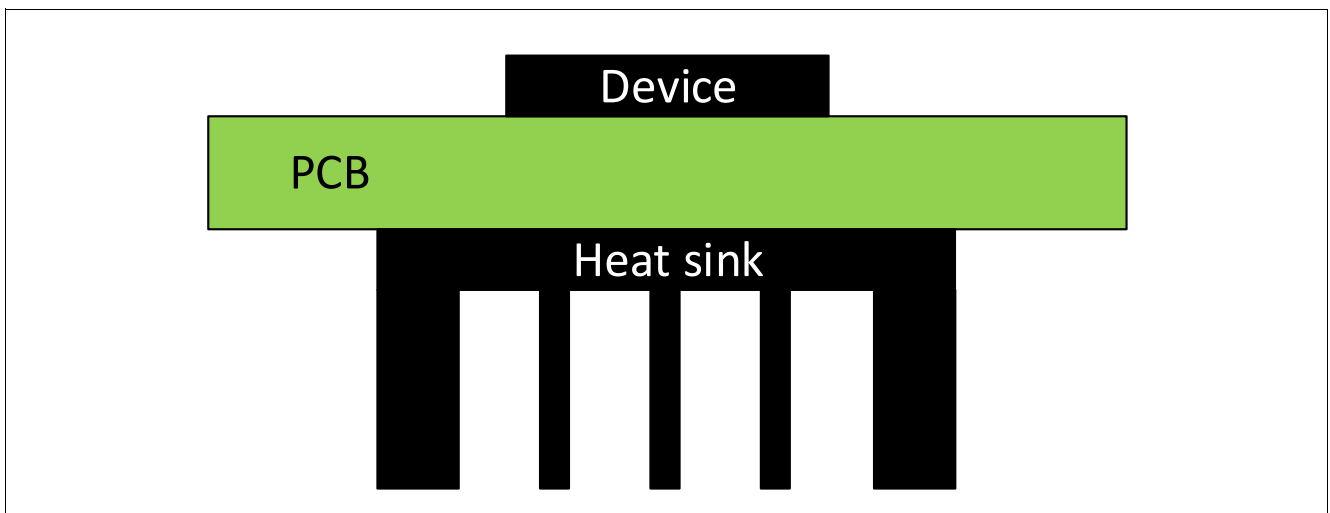

**Figure 3-3 Test board setting**

**Table 3-9 Test board parameters**

Description	Value
Dimension	85 mm x 36 mm
PCB material	FR4
PCB thickness	1.55 μm
No. of copper layers	4
Thickness of each copper layer	105 μm

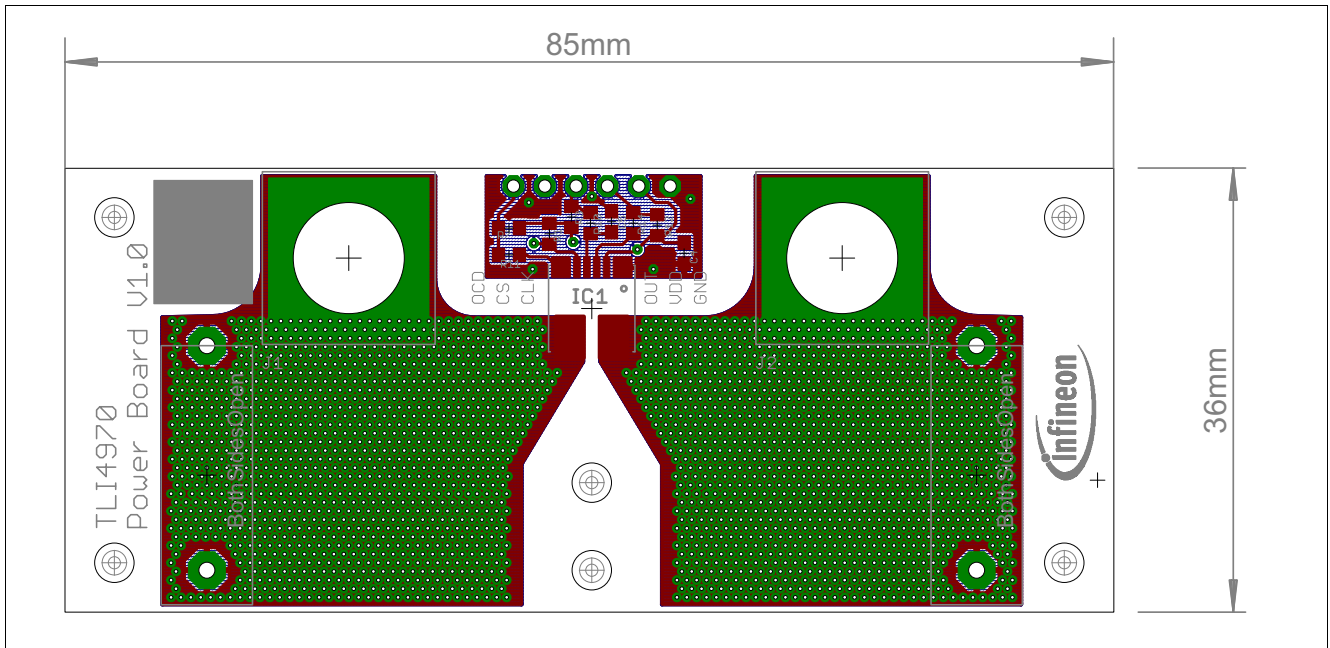

Figure 3-4 Dimension and layout of test board

In [Table 3-10](#) and [Figure 3-5](#) the used heat sink is described.

Table 3-10 Heat sink parameters

Description	Value
Type	SK68
Manufacturer	Fischer Elektronik
Dimension	33 mm x 46 mm x 50 mm
Thermal resistance	4.8 K/W

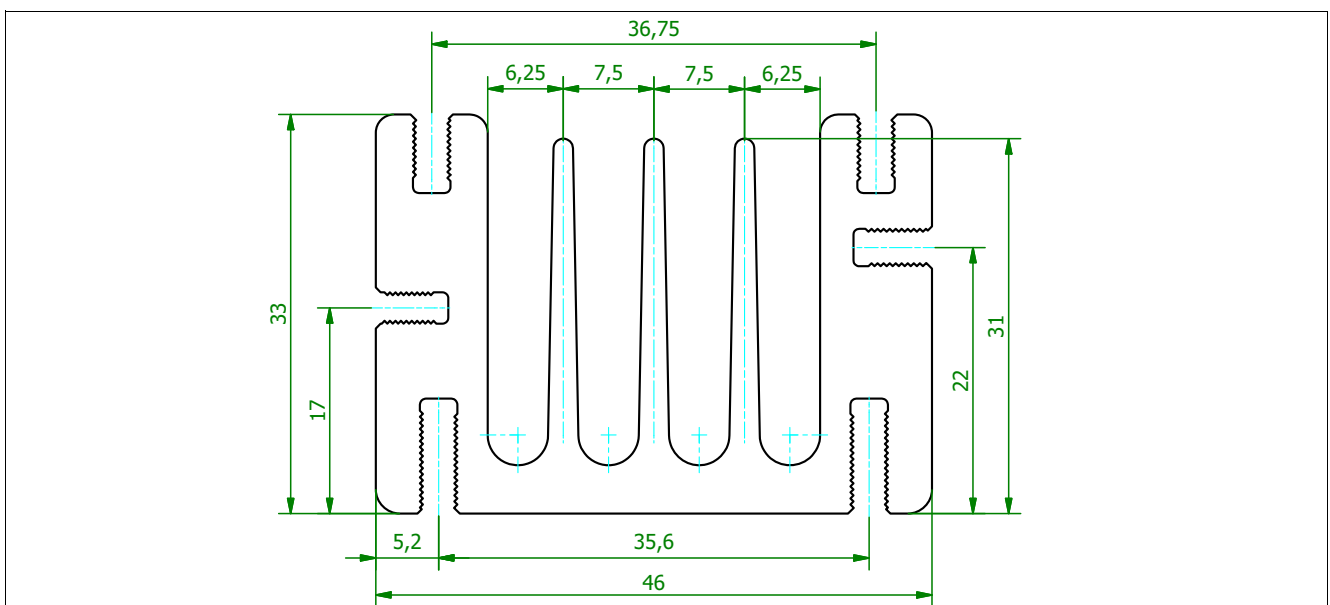

Figure 3-5 Heat sink dimension (in mm)

## 4 Interfaces

### 4.1 SPI Interface Definition

The TLI4970-D050T4 has a 3-pin serial peripheral interface (SPI). A standard unidirectional 16-bit SPI protocol is used. Several sensors can be connected to a parallel SPI bus. An example on how to connect multiple sensors is given in [Figure 3-2](#). The timing parameters are given in [Table 4-1](#).

#### 4.1.1 Logical Interface

All SPI frames are based on a 16-bit word. A parity bit in each SPI frame allows the detection of transmission errors and increases the reliability of the measured data. The transmission of the data is triggered by the  $\overline{CS}$ -pin.

##### 4.1.1.1 Protocol Description

The internal data register is continuously updated with the internal update rate  $f_{UPDATE}$ . When  $\overline{CS}$  is pulled to low, the actual value from the data register is written into the SPI output register. Like in standard SPI protocol, the sensor starts to transmit the data when clock pulses are applied to the SCLK pin and the  $\overline{CS}$ -pin is still low. With the next 16 clock pulses, the data word is sent out via the DOUT pin. If more than 16 clock pulses are sent by the SPI-Master and the  $\overline{CS}$ -pin stays low, the sensor sends 0's for all additional clock pulses. If a new sample should be read from the sensor, the  $\overline{CS}$ -pin has to return to the high state for at least the time  $t_{CSON}$  before pulling it to low again in order to trigger the next sample readout.

The clock pulses are ignored and the DOUT pin is in high ohmic state, when the  $\overline{CS}$ -pin is in "high" state. Therefore multiple chips can be readout on the same data bus by sequentially selecting the addressed sensor via the  $\overline{CS}$ -pin.

##### 4.1.1.2 Description of the SPI Data Frames

There are two different types of SPI frames sent from the sensor. The "Sensor Status Message" and the "Sensor Value Message". The two types are distinguished by the STATUS Bit. The DATA section contains different information. For details see below.

#### General structure of the 16-bit SPI data frame

GENERAL		Offset	Reset Value
16-bit SPI data frame		00 <sub>H</sub>	4000 <sub>H</sub>

15	14	13											0
STAT	PAR	DATA											
r	r	r											

Note: All fields marked as "r" are read-only values.

##### 4.1.1.3 Sensor Current Message

The actual measurement current value is returned in the Sensor Value Message.

### Structure of the Sensor Value Message

VALUE	Offset	Reset Value
Value of the actual current measurement	01 <sub>H</sub>	4000 <sub>H</sub>

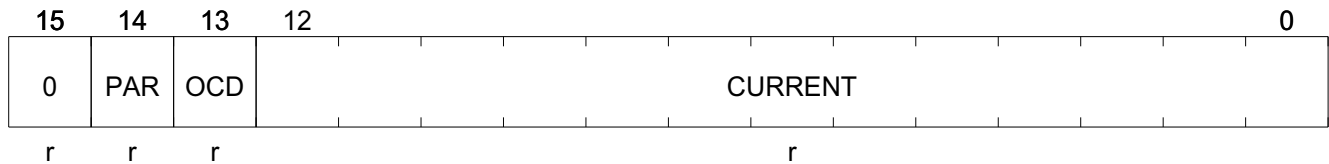

Field	Bits	Type	Description
0	15	r	<b>Status</b> Status identifier of a Sensor Value Word
PAR	14	r	<b>Parity Bit</b> Odd parity of current value. This bit is set in a way that the sum of all bits in the Value Word is odd.
OCD	13	r	<b>OCD-state</b> Over current comparator value 0 <sub>B</sub> No over current 1 <sub>B</sub> Over current detected
CURRENT	12:0	r	<b>Current value</b> Actual measured current value.

#### 4.1.1.4 Sensor Status Message

The Sensor Status Word contains information about temperature and load conditions and is sent under the following conditions:

- Once after start-up ("Sensor restarted")
- During the sensor start-up phase when a command is sent ("Sensor busy")
- If an internal error occurred ("Sensor fail")

### Structure of the Sensor Status Message

STATUS	Offset	Reset Value
Sensor status message	02 <sub>H</sub>	8000 <sub>H</sub>

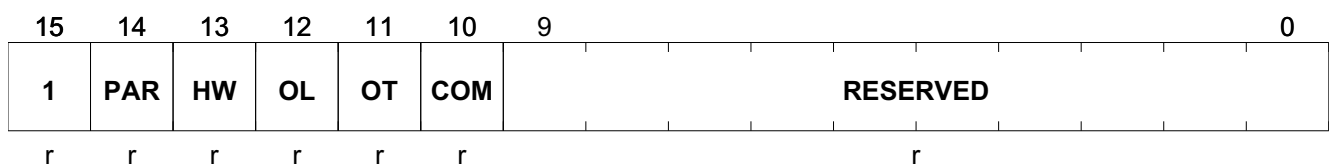



Field	Bits	Type	Description
1	15	r	<b>Status</b> Status identifier of a Sensor Status Word
PAR	14	r	<b>Parity Bit</b> Odd parity of current value. This bit is set in a way that the sum of all bits in the Status Word is odd.
HW	13	r	<b>Hardware error</b> 0 <sub>B</sub> OK 1 <sub>B</sub> Internal error; sensor not usable
OL	12	r	<b>Overload error</b> 0 <sub>B</sub> OK 1 <sub>B</sub> Overload (Current outside I <sub>PFSR</sub> range)
OT	11	r	<b>Temperature error</b> 0 <sub>B</sub> OK 1 <sub>B</sub> Temperature out of range
COM	10	r	<b>Communication error</b> 0 <sub>B</sub> OK 1 <sub>B</sub> No multiple of 16 SCLK cycles detected in last frame
RESERVED	9:0	r	<b>Reserved</b> Don't care - Reserved for future use

#### 4.1.2 Physical SPI Interface

The TLI4970-D050T4 has a 3-pin unidirectional SPI interface. This interface can be driven with a clock up to 5 MHz. The timing parameters are given in [Table 4-1](#). Electrical characteristics are given in [Table 4-2](#).

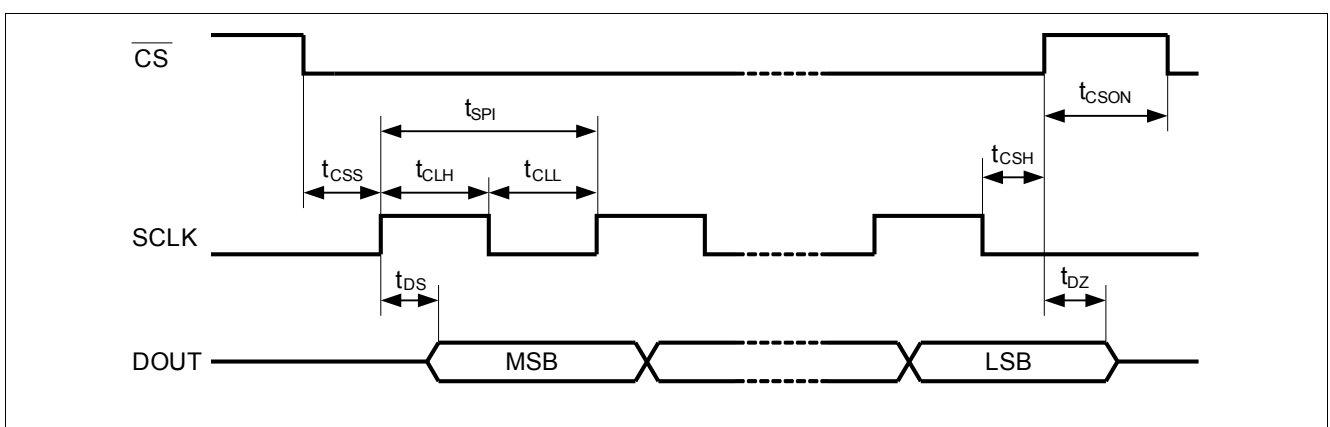

Figure 4-1 SPI interface timing: Readout of sensor data

**Table 4-1 Interface Timing Parameters<sup>1)</sup> (5MHz SPI clock speed)**

 General conditions (unless otherwise specified):  $V_{DD} = 3.3\text{ V}$ ;  $T_A = -40\text{ °C} \dots +85\text{ °C}$ 

Parameter	Symbol	Values			Unit	Note / Test Condition
		Min.	Typ.	Max.		
SPI speed (1 / bit time)	$f_{\text{SPI}}$	-	-	5	MHz	Duty cycle ratio 45% ... 55%
SPI period	$t_{\text{SPI}}$	200	-	-	ns	
SCLK duty cycle	$t_{\text{CLH}} / t_{\text{CLL}}$	45	-	55	%	
$\overline{\text{CS}}$ setup time	$t_{\text{CSS}}$	95	-	-	ns	$R_L \geq 100\text{ k}\Omega$ $C_L \leq 50\text{ pF}$ to GND
$\overline{\text{CS}}$ hold time	$t_{\text{CSH}}$	95	-	-	ns	$R_L \geq 100\text{ k}\Omega$ $C_L \leq 50\text{ pF}$ to GND
Data setup time	$t_{\text{DS}}$	-	-	65	ns	
Delay between $\overline{\text{CS}}$ rising edge and end of DOUT data	$t_{\text{DZ}}$	-	-	75	ns	
$\overline{\text{CS}}$ high time	$t_{\text{CSOH}}$	300	-	-	ns	

1) All timing parameters are valid on the sensor pin with the specified test load only. Different loading due to PCB mounting might result in different timing.

**Table 4-2 Interface Electrical Characteristics (5MHz SPI clock speed)**

 General conditions (unless otherwise specified):  $V_{DD} = 3.3\text{ V}$ ;  $T_A = -40\text{ °C} \dots +85\text{ °C}$ 

Parameter	Symbol	Values			Unit	Note / Test Condition
		Min.	Typ.	Max.		
Output level low (SPI)	$V_{\text{OL}}$	-	-	$0.2 \times V_{\text{DD}}$	V	Resistive load; 1 mA to GND
Output level high (SPI)	$V_{\text{OH}}$	$0.8 \times V_{\text{DD}}$	-	-	ns	Resistive load; 1 mA to GND
Input level low (SPI)	$V_{\text{IL}}$	-0.1	-	$0.3 \times V_{\text{DD}}$	V	
Input level high (SPI)	$V_{\text{IH}}$	$0.7 \times V_{\text{DD}}$	-	$V_{\text{DD}}$	V	
Input level hysteresis (SPI)		$0.05 \times V_{\text{DD}}$	-	-	V	
Input capacitance	$C_I$	-	-	100	pF	For all digital input pins
Input resistance	$R_I$	100	-	-	k $\Omega$	For all digital input pins
Load capacitance	$C_L$	-	-	50	pF	To GND; For all digital output pins
Load resistance	$R_L$	100	-	-	k $\Omega$	To $V_{\text{DD}}$ ; For all digital output pins

## 4.2 Serial Inspection and Configuration Interface (SICI)

The serial inspection and configuration interface is only used for EEPROM programming. This interface is a one wire interface provided by a double seizure of the OCD pin. To guarantee a proper SICI communication current must not flow through the primary conductor (to avoid interferences with potential over current detection). The instruction for the serial inspection and configuration interface can be found in the TLI4970 programming guide.

## 5 Package

The TLI4970-D050T4 is packaged in a RoHS compliant, halogen-free leadless package (QFN-like).

### 5.1 PG-TISON-8-1 Package Outline

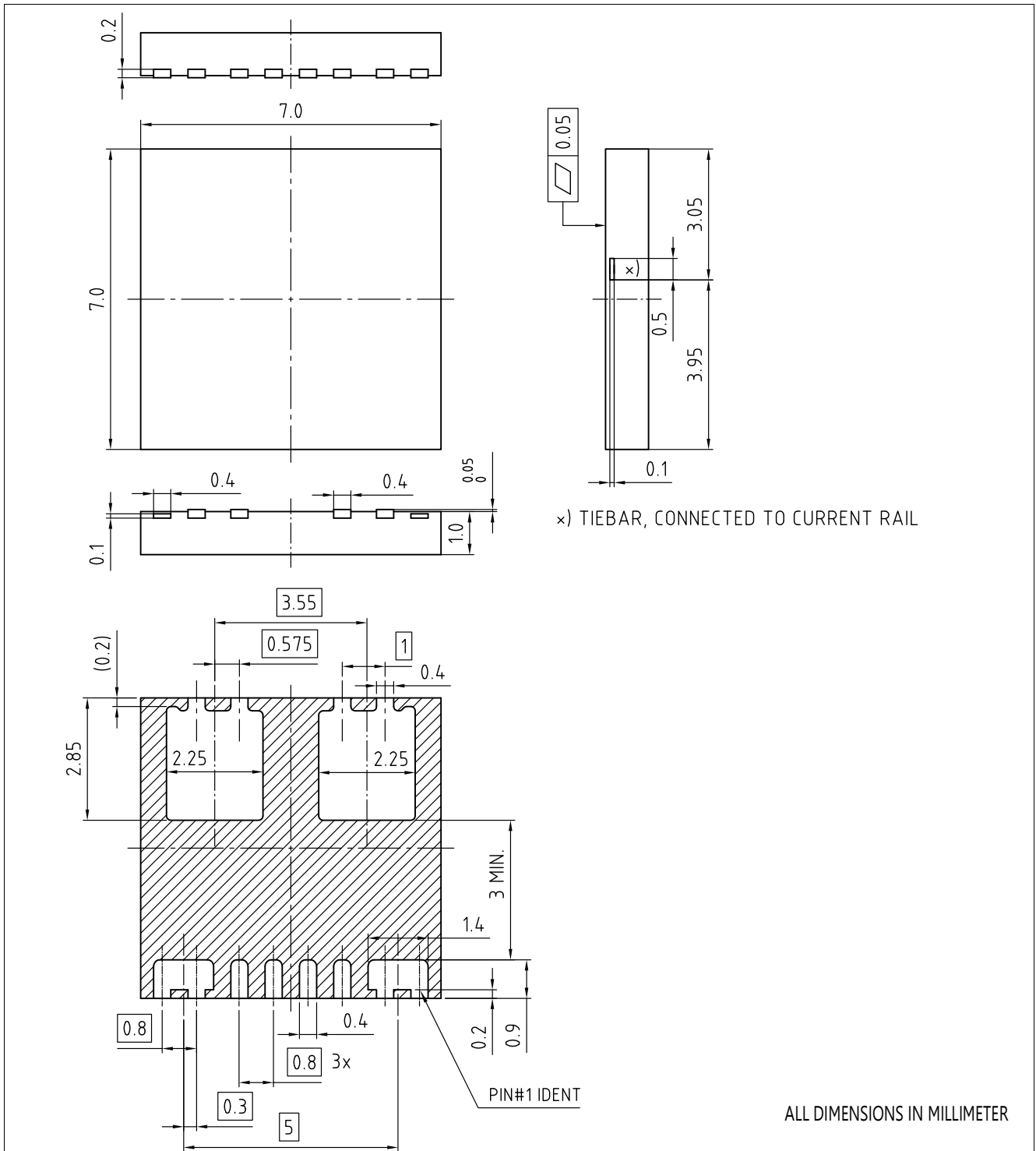

Figure 5-1 PG-TISON-8-1 package dimensions

5.2 Packing

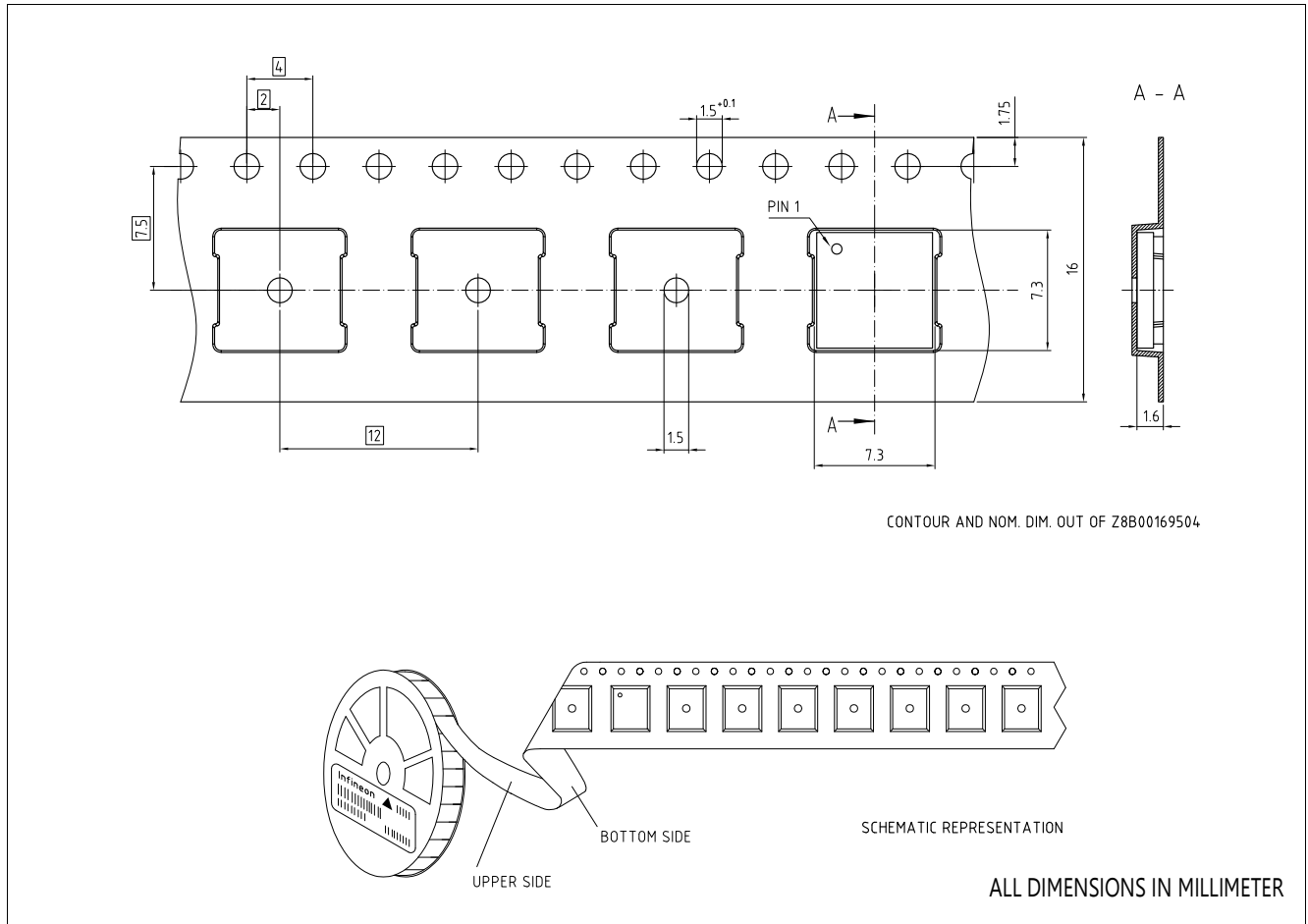

Figure 5-2 Carrier tape of the PG-TISON-8-1 package

### 5.3 Footprint Recommendation

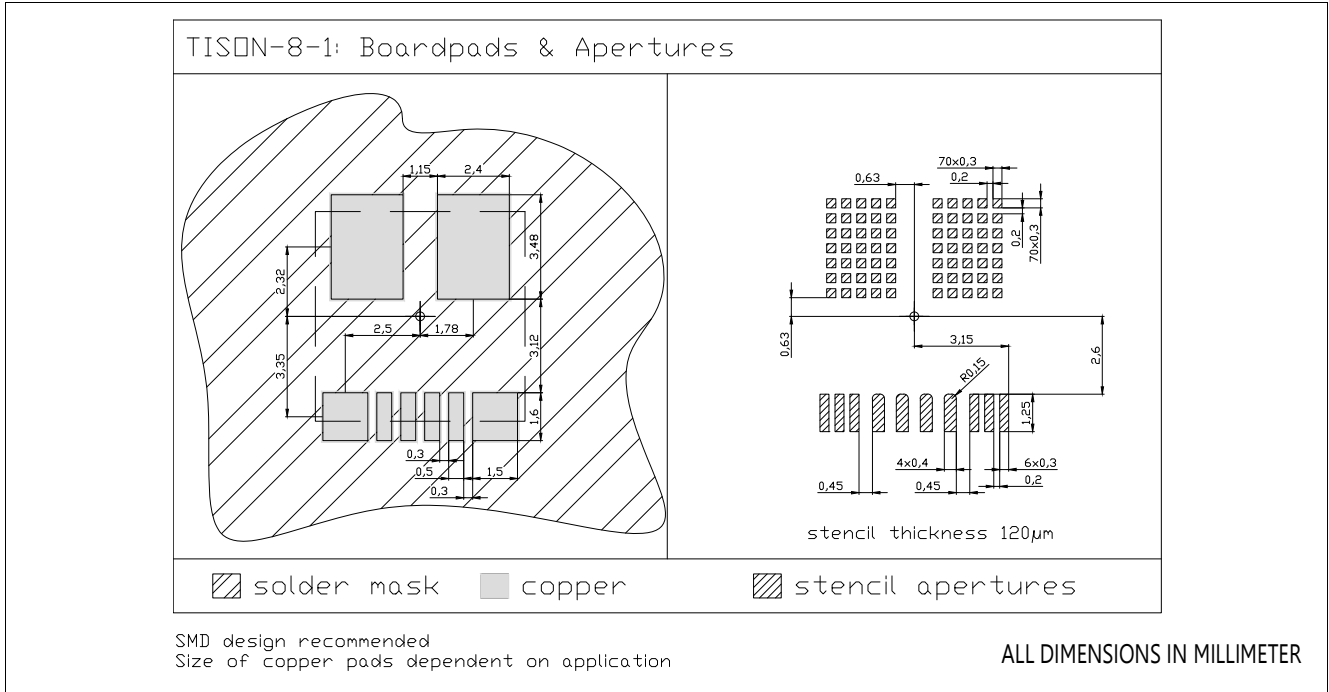

Figure 5-3 Footprint recommendation for reflow soldering

### 5.4 PCB Layout Recommendation

The PCB layout recommendation shown in [Figure 5.4](#) leads to the preferred current flow through the housing to achieve the highest accuracy.

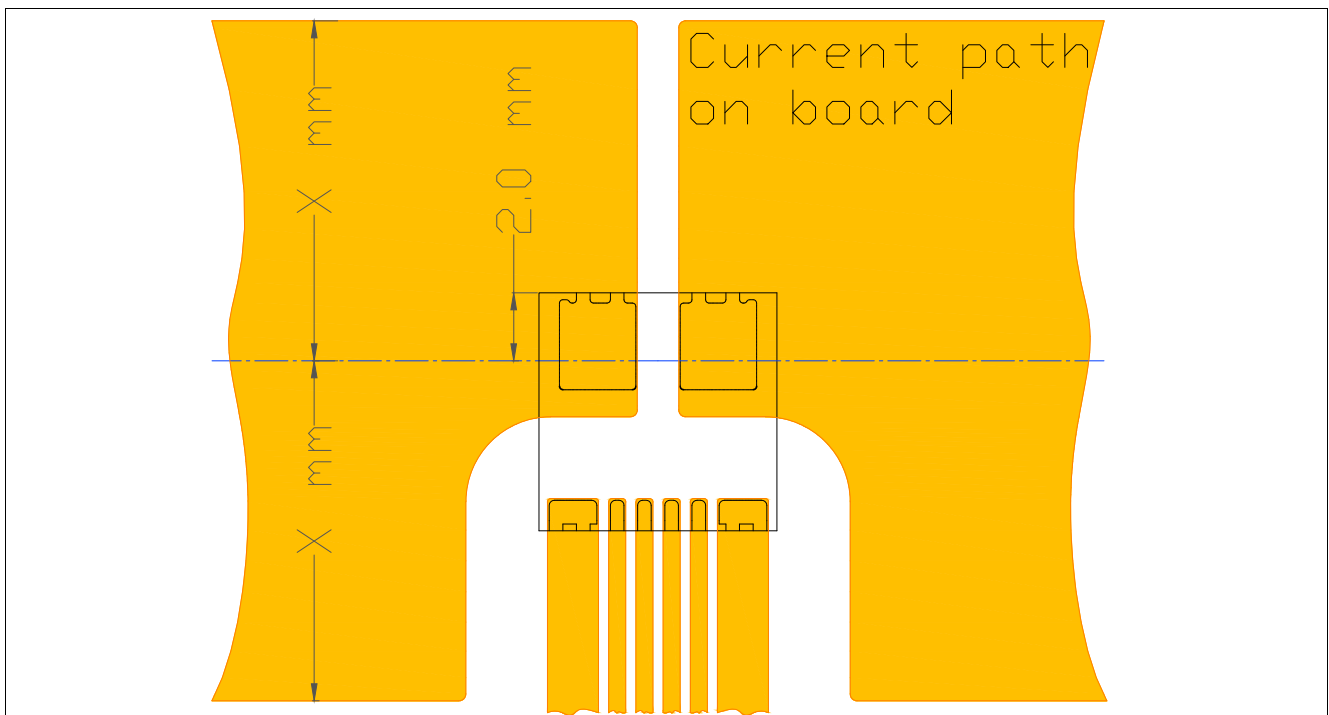

Figure 5-4 PCB layout recommendation

### 5.5 Laser Marking

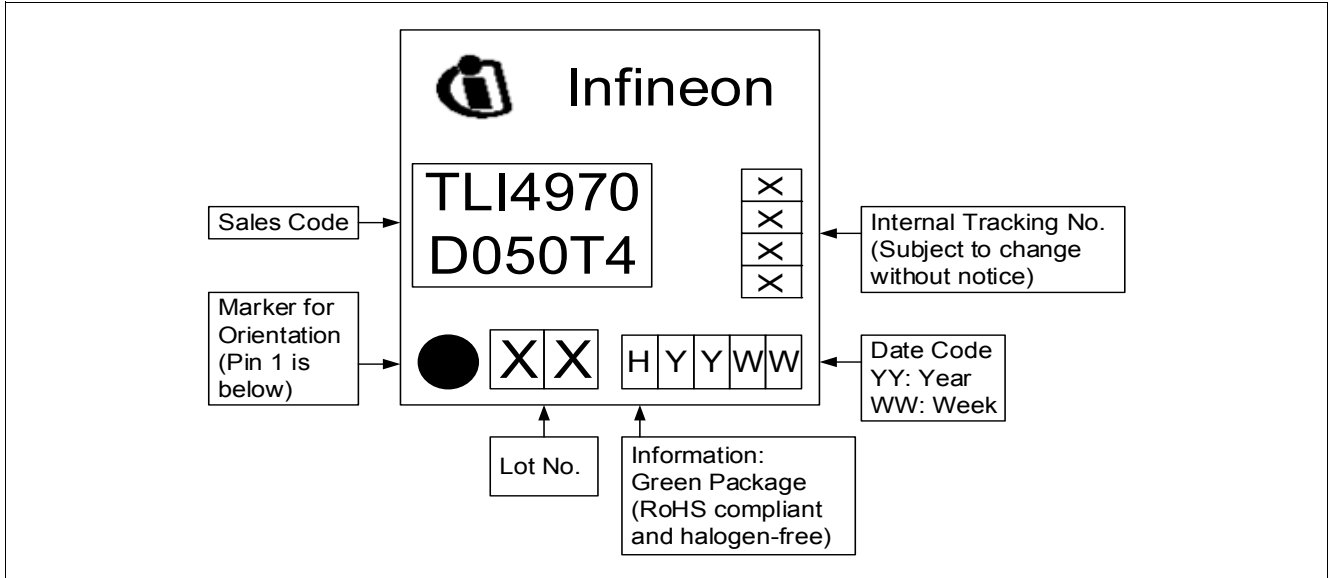

Figure 5-5 Laser marking on the top side

[www.infineon.com](http://www.infineon.com)

Published by Infineon Technologies AG

# Mouser Electronics

Authorized Distributor

Click to View Pricing, Inventory, Delivery & Lifecycle Information:

[Infineon:](#)

[TLI4970D050T4XUMA1](#) [TLI4970-D050T4](#)