



Surface Mount Glass Passivated Rectifier

**SMC (DO-214AB)****RoHS**
COMPLIANT
HALOGEN
FREE**FEATURES**

- Low profile package
- Ideal for automated placement
- Glass passivated pellet chip junction
- Low forward voltage drop
- Low leakage current
- High forward surge capability
- Meets MSL level 1, per J-STD-020, LF maximum peak of 260 °C
- Material categorization: for definitions of compliance please see www.vishay.com/doc?99912

TYPICAL APPLICATIONS

For use in general purpose rectification of power supplies, inverters, converters and freewheeling diodes for consumer, automotive and telecommunication.

MECHANICAL DATA

Case: SMC (DO-214AB)

Molding compound meets UL 94 V-0 flammability rating
Base P/N-M3 - halogen-free, RoHS-compliant, and commercial grade

Terminals: matte tin plated leads, solderable per J-STD-002 and JESD 22-B102

M3 suffix meets JESD 201 class 1A whisker test

Polarity: Color band denotes cathode end

PRIMARY CHARACTERISTICS	
$I_{F(AV)}$	5.0 A
V_{RRM}	50 V, 100 V, 200 V, 400 V, 600 V, 800 V, 1000 V
I_{FSM}	100 A
I_R	10 μ A
V_F	1.15 V
T_J max.	150 °C
Package	SMC (DO-214AB)
Circuit configuration	Single

MAXIMUM RATINGS ($T_A = 25$ °C unless otherwise noted)									
PARAMETER	SYMBOL	S5A	S5B	S5D	S5G	S5J	S5K	S5M	UNIT
Device marking code		5A	5B	5D	5G	5J	5K	5M	
Max. repetitive peak reverse voltage	V_{RRM}	50	100	200	400	600	800	1000	V
Max. RMS voltage	V_{RMS}	35	70	140	280	420	560	700	V
Max. DC blocking voltage	V_{DC}	50	100	200	400	600	800	1000	V
Max. average forward rectified current at $T_L = 75$ °C	$I_{F(AV)}$	5.0							A
Peak forward surge current 8.3 ms single half sine-wave superimposed on rated load	I_{FSM}	100							A
Operating junction and storage temperature range	T_J, T_{STG}	-55 to +150							°C



ELECTRICAL CHARACTERISTICS ($T_A = 25\text{ }^\circ\text{C}$ unless otherwise noted)											
PARAMETER	TEST CONDITIONS	SYMBOL	S5A	S5B	S5D	S5G	S5J	S5K	S5M	UNIT	
Max. instantaneous forward voltage	5.0 A	V_F	1.15								V
Max. DC reverse current at rated DC blocking voltage	$T_A = 25\text{ }^\circ\text{C}$	I_R	10								μA
	$T_A = 125\text{ }^\circ\text{C}$		250								
Typical reverse recovery time	$I_F = 0.5\text{ A}$, $I_R = 1.0\text{ A}$, $I_{rr} = 0.25\text{ A}$	t_{rr}	2.5								μs
Typical junction capacitance	4.0 V, 1 MHz	C_J	40								pF

THERMAL CHARACTERISTICS ($T_A = 25\text{ }^\circ\text{C}$ unless otherwise noted)										
PARAMETER	SYMBOL	S5A	S5B	S5D	S5G	S5J	S5K	S5M	UNIT	
Typical thermal resistance ⁽¹⁾	$R_{\theta JL}$	10								$^\circ\text{C/W}$

Note

⁽¹⁾ Thermal resistance from junction to lead mounted on PCB with 0.3" x 0.3" (8.0 mm x 8.0 mm) copper pad area

ORDERING INFORMATION (Example)				
PREFERRED P/N	UNIT WEIGHT (g)	PREFERRED PACKAGE CODE	BASE QUANTITY	DELIVERY MODE
S5J-M3/57T	0.211	57T	850	7" diameter plastic tape and reel
S5J-M3/9AT	0.211	9AT	3500	13" diameter plastic tape and reel

RATINGS AND CHARACTERISTICS CURVES ($T_A = 25\text{ }^\circ\text{C}$ unless otherwise noted)

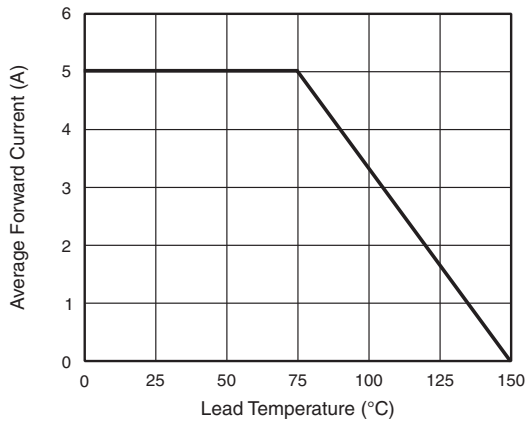

Fig. 1 - Forward Current Derating Curve

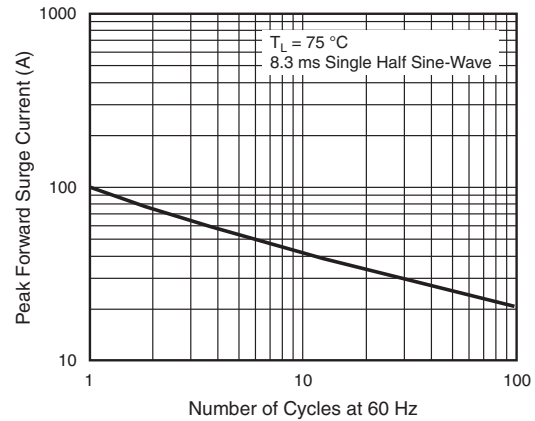

Fig. 2 - Max. Non-Repetitive Peak Forward Surge Current

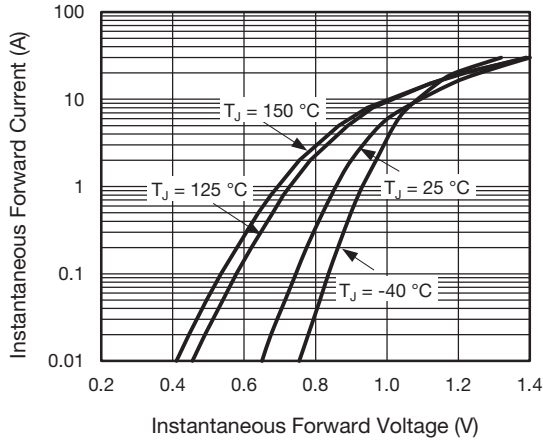

Fig. 3 - Typical Instantaneous Forward Characteristics

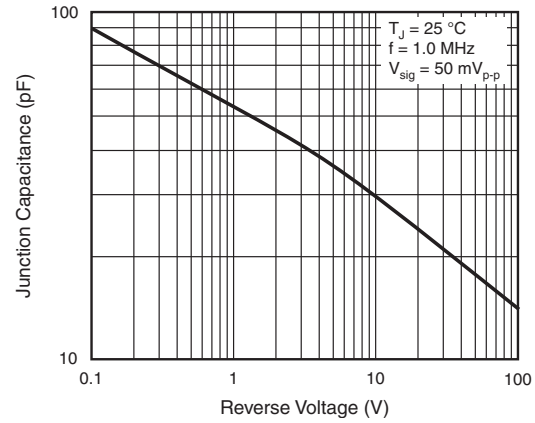

Fig. 5 - Typical Junction Capacitance

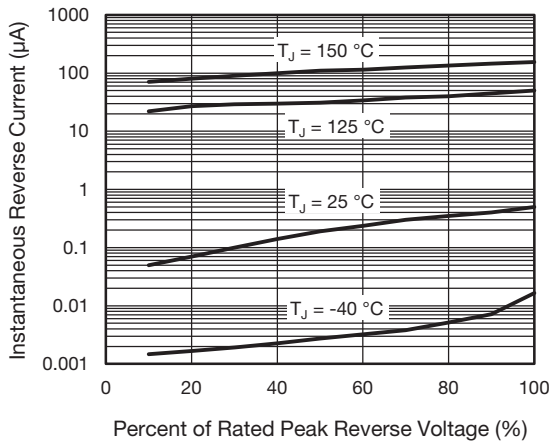
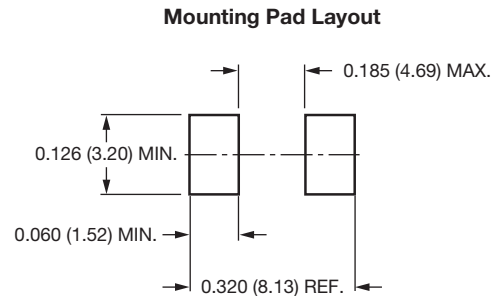
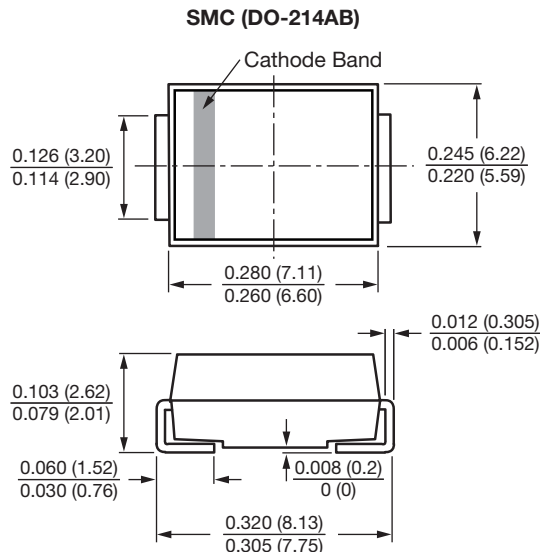

Fig. 4 - Typical Reverse Characteristics

PACKAGE OUTLINE DIMENSIONS in inches (millimeters)





Disclaimer

ALL PRODUCT, PRODUCT SPECIFICATIONS AND DATA ARE SUBJECT TO CHANGE WITHOUT NOTICE TO IMPROVE RELIABILITY, FUNCTION OR DESIGN OR OTHERWISE.

Vishay Intertechnology, Inc., its affiliates, agents, and employees, and all persons acting on its or their behalf (collectively, "Vishay"), disclaim any and all liability for any errors, inaccuracies or incompleteness contained in any datasheet or in any other disclosure relating to any product.

Vishay makes no warranty, representation or guarantee regarding the suitability of the products for any particular purpose or the continuing production of any product. To the maximum extent permitted by applicable law, Vishay disclaims (i) any and all liability arising out of the application or use of any product, (ii) any and all liability, including without limitation special, consequential or incidental damages, and (iii) any and all implied warranties, including warranties of fitness for particular purpose, non-infringement and merchantability.

Statements regarding the suitability of products for certain types of applications are based on Vishay's knowledge of typical requirements that are often placed on Vishay products in generic applications. Such statements are not binding statements about the suitability of products for a particular application. It is the customer's responsibility to validate that a particular product with the properties described in the product specification is suitable for use in a particular application. Parameters provided in datasheets and / or specifications may vary in different applications and performance may vary over time. All operating parameters, including typical parameters, must be validated for each customer application by the customer's technical experts. Product specifications do not expand or otherwise modify Vishay's terms and conditions of purchase, including but not limited to the warranty expressed therein.

Except as expressly indicated in writing, Vishay products are not designed for use in medical, life-saving, or life-sustaining applications or for any other application in which the failure of the Vishay product could result in personal injury or death. Customers using or selling Vishay products not expressly indicated for use in such applications do so at their own risk. Please contact authorized Vishay personnel to obtain written terms and conditions regarding products designed for such applications.

No license, express or implied, by estoppel or otherwise, to any intellectual property rights is granted by this document or by any conduct of Vishay. Product names and markings noted herein may be trademarks of their respective owners.