

PART
NAME

JUNCTION BOX

PART
No.

JB-3956

REVISION
DATE

7-18-11

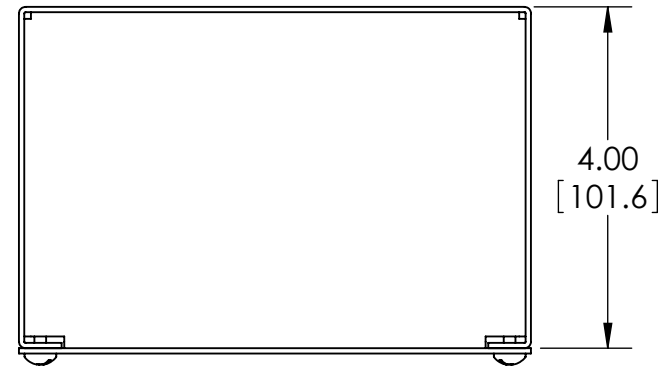

MATERIAL - 16 GA. [1.5mm] STEEL
FINISH - SMOOTH GRAY POWDERCOAT

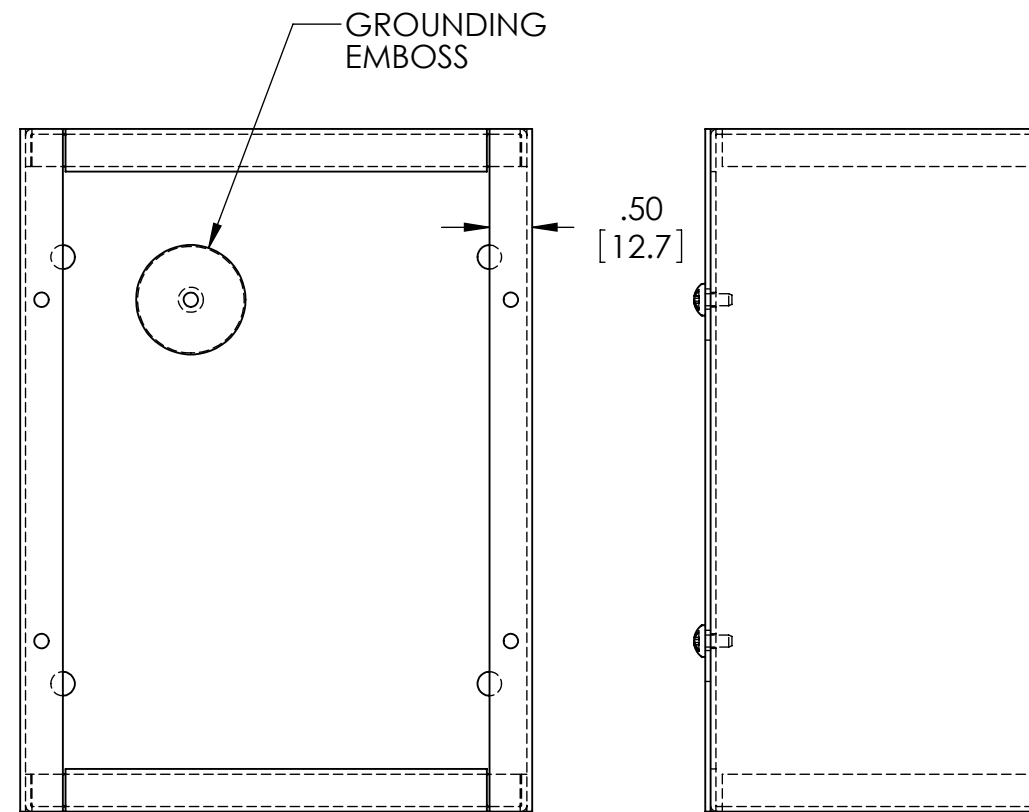
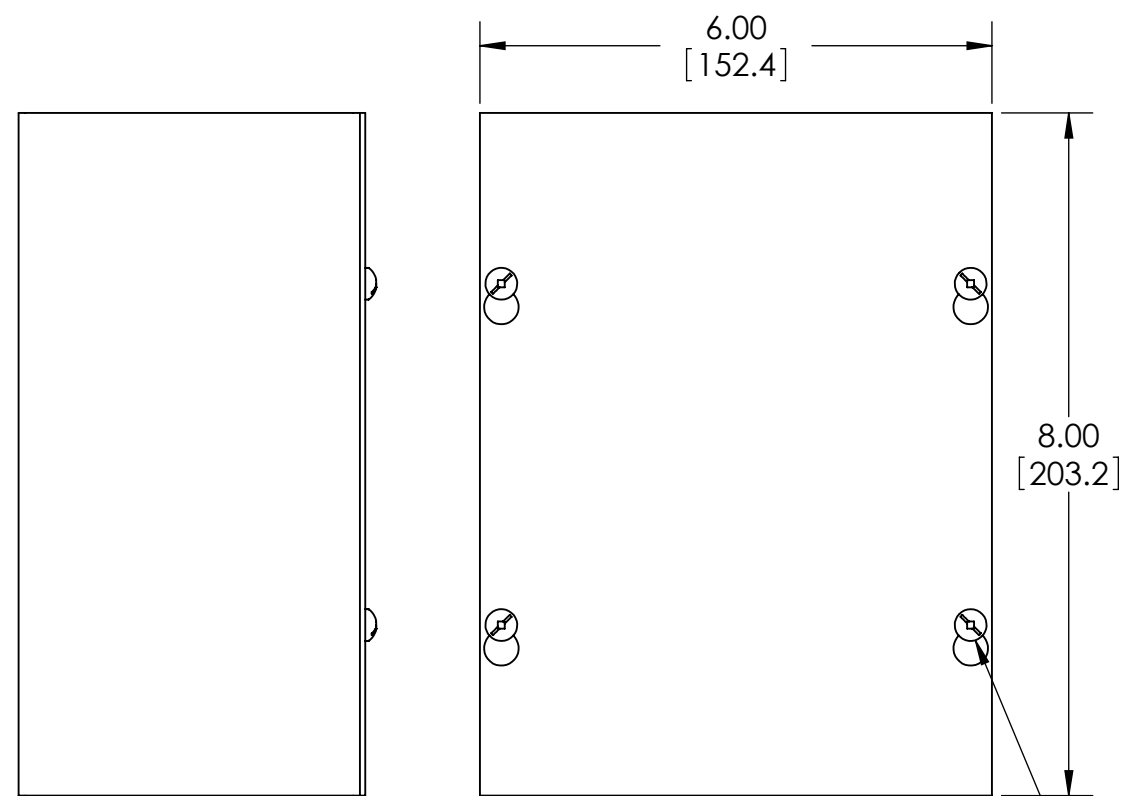
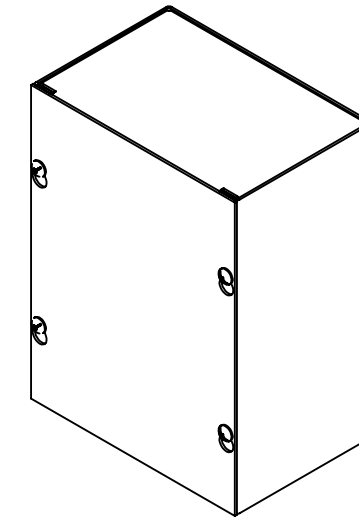

COVER REMOVED

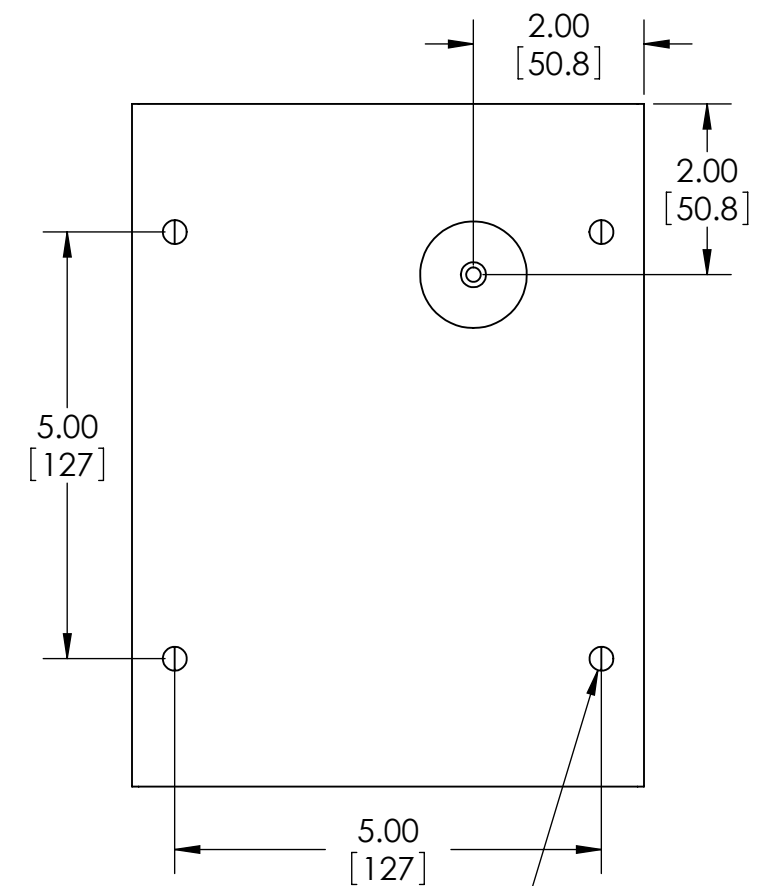

SCREWS: #10-32 x .31" [8mm] LG.
MACHINE, PAN HEAD, SLOTTED/SQUARE
COMBINATION STYLE DRIVE, STEEL, ZINC PLATED.
(SUPPLIED FOR COVER MOUNTING AND
FOR GROUND POINT).

Mouser Electronics

Authorized Distributor

Click to View Pricing, Inventory, Delivery & Lifecycle Information:

[Bud Industries:](#)

[JB-3956](#) [JB-3956-KO](#)