

REVISIONS

P	LTR	DESCRIPTION	DATE	DWN	APVD
	BA1	ECR-14-010250	16JUL2014	KR	TN

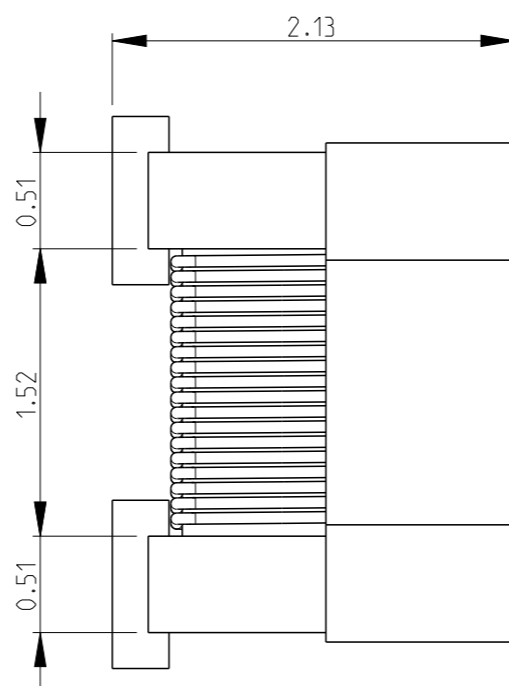
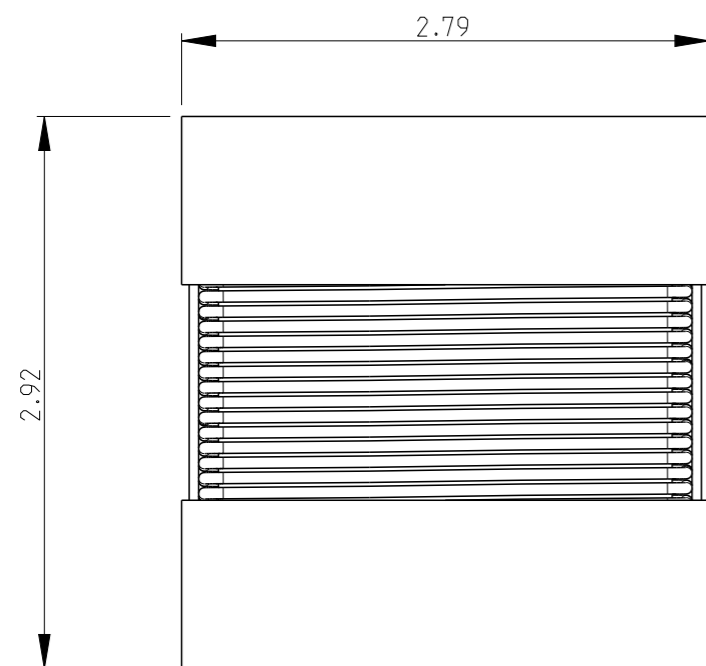

- 1 TERMINAL WRAPAROUND APPROX 0.007" (0.18mm) BOTH ENDS
- 2 FOR FURTHER INFORMATION SEE DATA SHEET FOR 3650 SERIES-LOW INDUCTANCE, HIGH FREQUENCY CHIP INDUCTOR

RECOMMENDED LAND PATTERN FOR 3650-2C SERIES

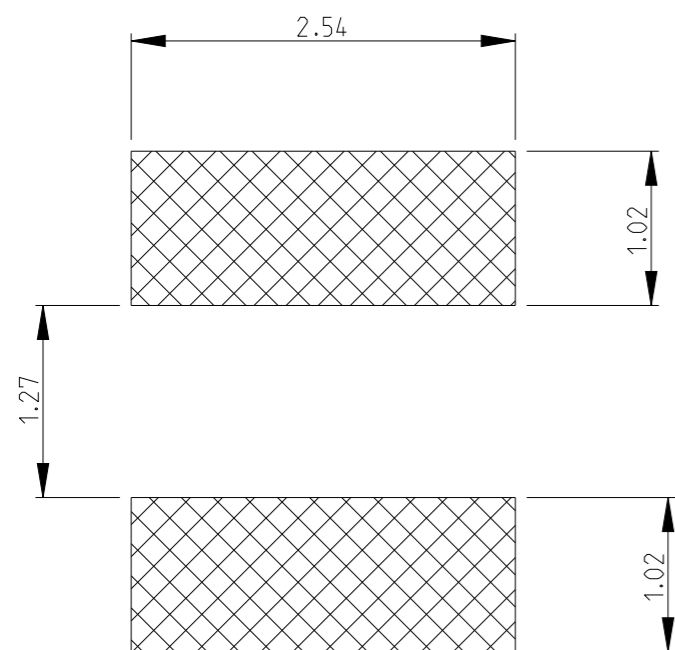

ROHS Compliant

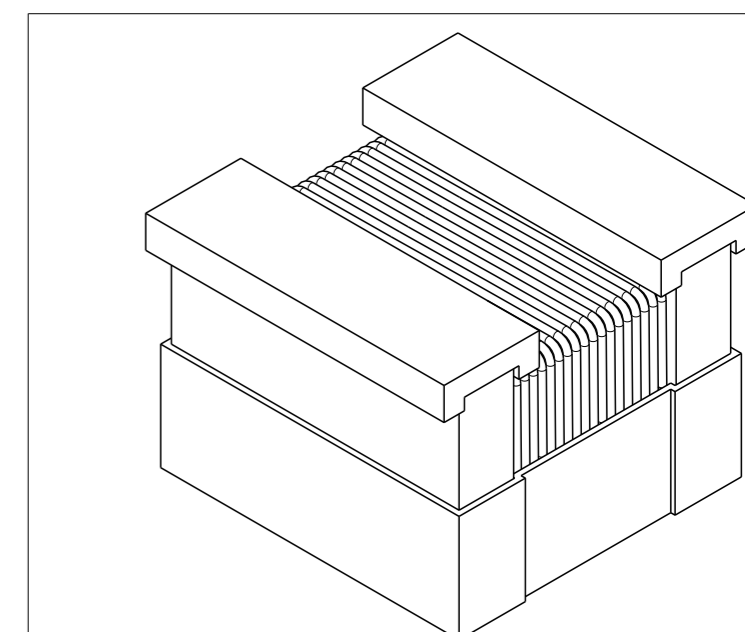
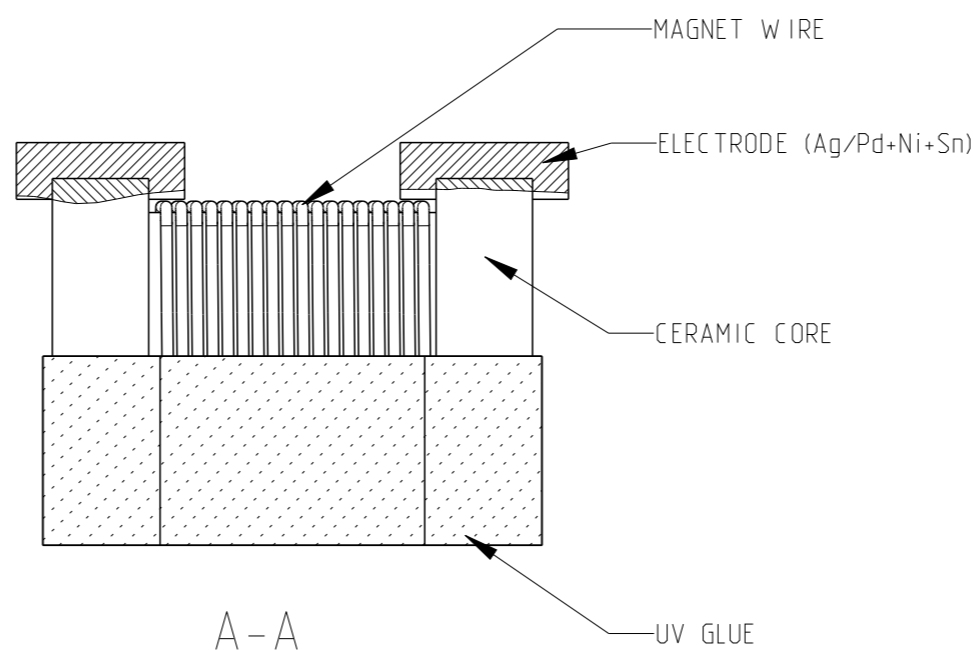

THIS DRAWING IS A CONTROLLED DOCUMENT.

DIMENSIONS:		TOLERANCES UNLESS OTHERWISE SPECIFIED:	
mm			
0 PLC	±0.2		
1 PLC	±0.1		
2 PLC	±		
3 PLC	±		
4 PLC	±		
ANGLES	±5°		
MATERIAL		FINISH	
-	-	-	-

DWN	SUBHASH.M	04-AUG-09
CHK	ALLAN.P	04-AUG-09
APVD	STEPHEN.P	04-AUG-09
PRODUCT SPEC	-	-
APPLICATION SPEC	-	-
WEIGHT	-	-
Customer Drawing		



LOW INDUCTANCE, HIGH FREQUENCY CHIP INDUCTOR SERIES 3650 2C

NAME	SIZE	CAGE CODE	DRAWING NO	RESTRICTED TO
-	A3	00779	C-1879023	-
SCALE		SHEET		REV
NTS		1 OF 1		BA1

Mouser Electronics

Authorized Distributor

Click to View Pricing, Inventory, Delivery & Lifecycle Information:

[TE Connectivity:](#)

[36502CR43JTDG](#)