

PCB LAYOUT - COMPONENT VIEW

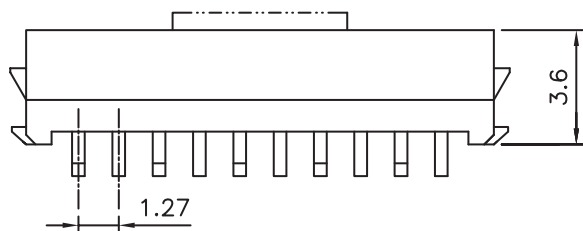

Pick & Place Pad

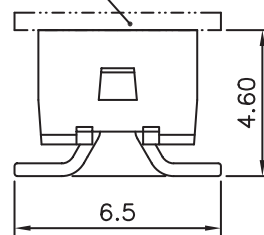

MATERIAL:  
 HOUSING MATERIAL: PA6T  
 FLAMABILITY RATING: UL94-V0  
 COLOR: RED  
 CONTACT MATERIAL: PHOSPHOR BRONZE  
 CONTACT TYPE: STAMPED  
 CONTACT PLATING: MATT TIN OVER NICKEL  
 QUALITY CLASS: 25 MATING CYCLES  
 PITCH: 2.54 MM PER ROW

ENVIRONMENTAL:  
 OPERATING TEMPERATURE: -40°C UP TO 105°C  
 COMPLIANCE: LEAD FREE AND ROHS

ELECTRICAL:  
 CURRENT RATING: 1.5A PER PIN (PCB PIN)  
 WORKING VOLTAGE: 100VAC  
 INSULATION RESISTANCE: >1000MOHM  
 DIELECTRIC WITHSTANDING VOLT.: 500VAC/MN  
 CONTACT RESISTANCE: 10mOHM MAX

STANDARD  
 RoHS CERTIFIED: E323964 / MOD. NUMBER 69035728xx7x

SOLDERING:  
 REFLOW PROCESS ONLY

DIMENSION:  
 DIM.A= 1.27 x No. of Spaces  
 DIM.B= DIM.A + 3.30  
 DIM.C= DIM.A + 4.30

AVAILABLE  
 xx : 4 TO 26 CIRCUITS

PACKAGING:  
 TAPE & REEL

RoHS Compliant			
H	06-MAR-13	C DIM ADD	QL
REV	DATE	FILE	BY

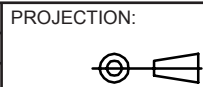

GENERAL TOLERANCE  
 .X = +/- 0.2  
 .XX = +/- 0.15



APPROVAL: RJ

UNIT: MM  
 SCALE:  
 SHEET: 1/2  
 DRAW: EAGER

DESCRIPTION: MM MALE SMT CONNECTOR WITHOUT LATCH AND WITHOUT POLARIZATION

WERI PART NO: 690 357 28 xx 76

SIZE  
**A4**

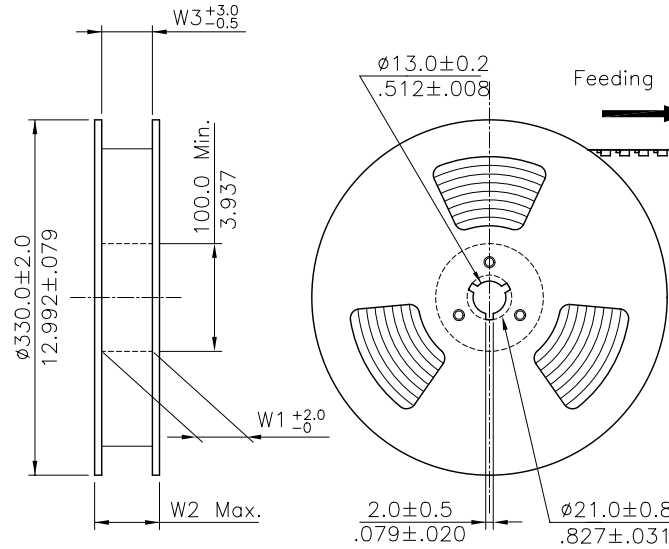



NOTES:

1. 10 sprocket hole pitch cumulative tolerance  $\pm 0.20\text{mm}$ .
2. Carrier camber not to exceed 1 mm in 100 mm.
3. Material :Transparent Anti-static Polysyrene.
4. All dimensions meet EIA-481-3 requirements.
5. Thickness :  $0.40 \pm 0.05\text{mm}$ .
6. Packing length per 22" Reel : 30.6 Meters.
7. Component load per 13" Reel : 1000 pcs.

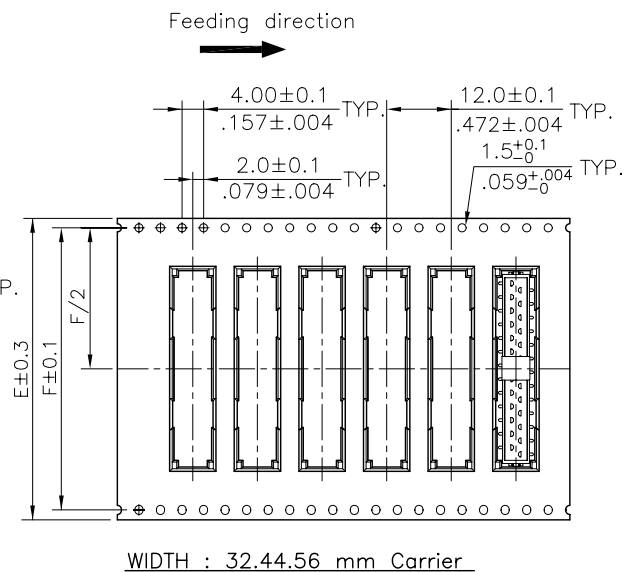
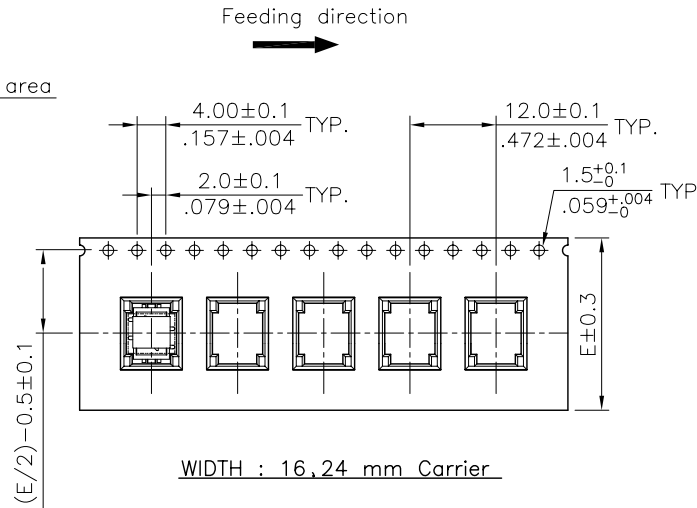
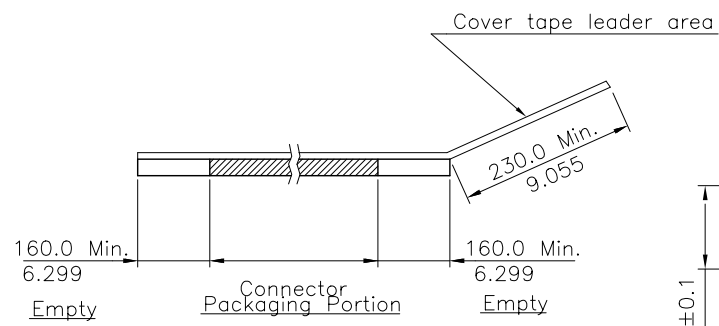
Circuits	Dimension					Packing (Reel/Caton)
	E	F	W1	W2	W3	
4	16.0(.630)	-	16.5(.650)	22.5(.886)	16.5(.650)	11
6~10	24.0(.945)	-	24.5(.965)	30.5(1.201)	24.5(.965)	9
10~14	32.0(1.260)	28.40(1.118)	32.5(1.280)	38.5(1.516)	32.5(1.280)	7
16~22	44.0(1.732)	40.40(1.596)	44.5(1.752)	50.5(1.988)	44.5(1.752)	5
24~26	56.0(2.205)	52.40(2.063)	56.5(2.224)	62.5(2.461)	56.5(2.224)	4

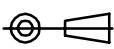

RoHS Compliant				PROJECTION: 	GENERAL TOLERANCE .X = $\pm$ 0.2 .XX = $\pm$ 0.15		DESCRIPTION: MM MALE SMT CONNECTOR WITHOUT LATCH AND POLARIZATION WERI PART NO: 690 357 28 xx 76	SIZE <b>A4</b>
G								
F								
E								
D								
C				APPROVAL: RJ	UNIT: MM	DESCRIPTION: MM MALE SMT CONNECTOR WITHOUT LATCH AND POLARIZATION		
B					SCALE:	WERI PART NO: 690 357 28 xx 76		
A					SHEET: 2/2			
REV	DATE	FILE	BY		DRAW: EAGER			

# Mouser Electronics

Authorized Distributor

Click to View Pricing, Inventory, Delivery & Lifecycle Information:

[Wurth Electronics:](#)

[690357280876](#) [690357281076](#) [690357280676](#) [690357281276](#) [690357280476](#) [690357282076](#)