

AVO75 Series DC/DC Converter

Technical Reference Notes

Industry Standard Eighth Brick: 36~75V Input, 1.2V~12V Single Output

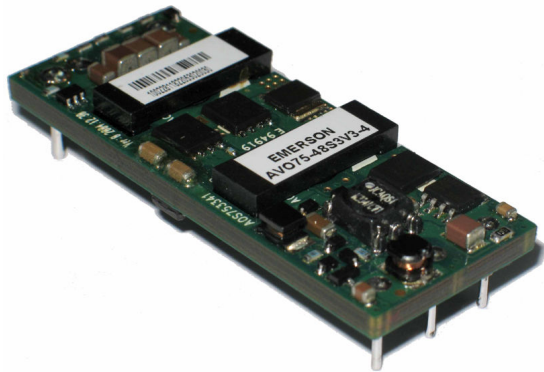

Industry standard eighth brick: 2.28" × 0.9" × 0.34"

Options

- Choice of positive logic or negative logic for CNT function
- Choice of short pins or long pins

Description

The AVO75 series DC/DC converter is a new open frame DC/DC converter for optimum efficiency and power density. The series provides up to 25A output current in an industry standard eighth brick, which makes it an ideal choice for small space, high current and low voltage applications. The AVO75 series uses an industry standard eighth brick: 57.9mm × 22.9mm × 8.9mm (2.28" × 0.9" × 0.35") and standard pin-out configuration, provides CNT and trim functions. AVO75 series can provide 1.2V ~ 12V single output, and outputs are isolated from inputs. The series can achieve ultra high efficiency, and for most applications, a heat sink is not required.

Features

- Delivers up to 25A output current
- Industry standard eighth brick foot print 57.9mm × 22.9mm × 8.5mm (2.28" × 0.9" × 0.34")
- Basic isolation
- Ultra high efficiency: 92% at 5V full load (Vin = 48Vdc)
- Improved thermal performance: full load at 55°C at 1m/s (200LFM) for 5Vo
- High power density
- Low output noise
- 2:1 wide input voltage of 36V-75V
- CNT function
- Remote sense
- Trim function: +10%/-20%
- Input under-voltage lockout
- Output over-current protection
- Output over-voltage protection
- Over-temperature protection
- RoHS compliant

Module Numbering

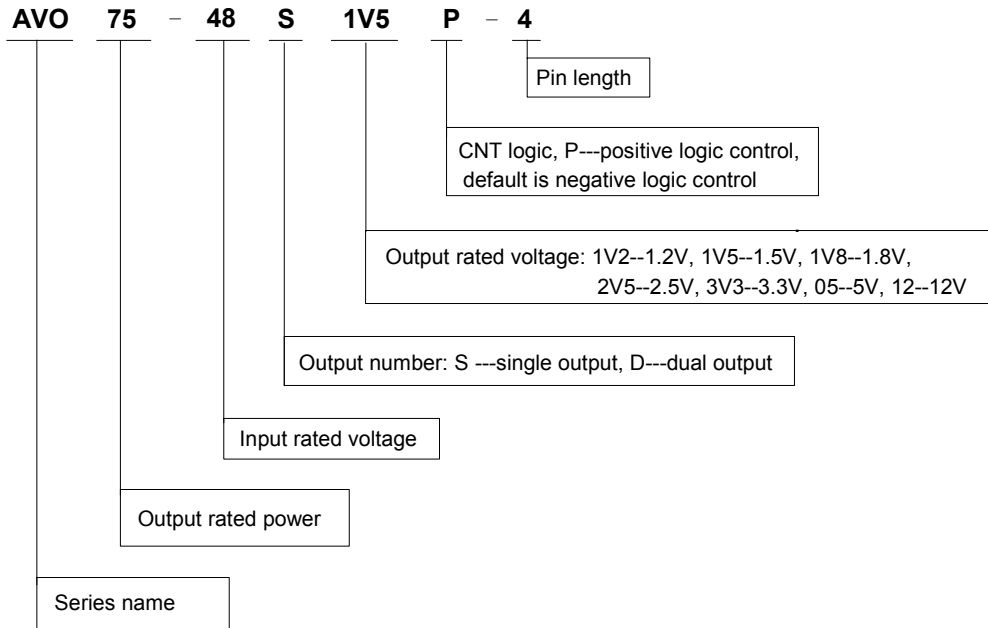

Electrical Specifications

Unless otherwise indicated, specifications apply over all operating input voltage and temperature conditions. Standard test condition on a single unit is as follows:

Tc (board): 25 °C
 +Vin: 48V± 2%
 -Vin: return pin for +Vin
 CNT: connected to -Vin for negative logic
 open for positive logic
 +Vout: connected to load
 -Vout: connected to load (return)
 +Sense: connected to +Vout
 -Sense: connected to -Vout
 Trim (Vadj): open

Input Specifications

| Parameter | Symbol | Min | Typ | Max | Unit |
|---|-------------|-----|-----|-----|-----------------|
| Operating Input Voltage | V_I | 36 | 48 | 75 | V _{DC} |
| Maximum Input Current ($V_I = 0$ to $V_{I,max}$, $I_o = I_{o,max}$) | $I_{I,max}$ | - | - | 2.5 | A |
| Input Reflected-ripple Current (5Hz to 20MHz, 12μH source impedance, $T_A = 25$ °C) | I_I | - | - | 20 | mAp-p |
| Supply Voltage Rejection (1kHz) | - | 50 | 60 | - | dB |

Caution: This power module is not internally fused. An input line fuse must always be used.

Absolute Maximum Ratings

Stresses in excess of the absolute maximum ratings can cause permanent damage to the device. These are absolute stress ratings only. Functional operation of the device is not implied at these or any other conditions in excess of those given in the operational sections of the IPS. Exposure to absolute maximum ratings for extended periods can adversely affect device reliability.

| Parameter | | Device | Symbol | Min | Typ | Max | Unit |
|--|----------------------|--------|---------------|-----|-----|------|------|
| Input Voltage | Continuous | All | V_i | 0 | - | 75 | Vdc |
| | Transient (100ms) | All | $V_{i,trans}$ | 0 | - | 100 | Vdc |
| Operating Ambient Temperature (See Thermal Consideration) | | All | T_a | -40 | - | 85 | °C |
| Operating Board Temperature | | All | T_c | - | - | 100 | °C |
| Storage Temperature | | All | T_{STG} | -55 | - | 125 | °C |
| Operating Humidity | | All | - | - | - | 85 | % |
| Basic Input-Output Isolation (Conditions: 1mA for 60 sec, slew rate of 1500V/10sec) | | All | - | | | 2000 | Vdc |
| Output Power | 1.2V | | $P_{o,max}$ | 0 | - | 30 | W |
| | 1.5V | 37.5 | | | | | |
| | 1.8V | 45 | | | | | |
| | 2.5V | 62.5 | | | | | |
| | 3.3V | 66 | | | | | |
| | 5V | 75 | | | | | |
| | 12V | 75 | | | | | |

Output Specifications

| Parameter | | Device | Symbol | Min | Typ | Max | Unit |
|---|-------------------------------------|--------|-------------|-------|-----|--------|-------|
| Output ripple and noise peak-to-peak (5Hz to 20MHz) (across 1µF @50V, X7R ceramic capacitor & 470µF @25V LOW ESR aluminum capacitor) | | 1.2V | | | 50 | | mVp-p |
| | | 1.5V | | | 55 | | |
| | | 1.8V | | | 45 | | |
| | | 2.5V | - | - | 50 | - | |
| | | 3.3V | | | 50 | | |
| | | 5V | | | 55 | | |
| | | 12V | | | 55 | | |
| External load capacitance | | 1.2V | | | | 10,000 | µF |
| | | 1.5V | | | | 10,000 | |
| | | 1.8V | | | | 10,000 | |
| | | 2.5V | - | 220 | 470 | 10,000 | |
| | | 3.3V | | | | 10,000 | |
| | | 5V | | | | 5000 | |
| | | 12V | | | | 1000 | |
| Output voltage setpoint ($V_I=V_{I,min}$ to $V_{I,max}$; $I_o=I_{o,max}$; $T_a=25^\circ\text{C}$) | | 1.2V | | 1.18 | 1.2 | 1.22 | Vdc |
| | | 1.5V | | 1.48 | 1.5 | 1.52 | |
| | | 1.8V | | 1.77 | 1.8 | 1.83 | |
| | | 2.5V | $V_{o,set}$ | 2.46 | 2.5 | 2.54 | |
| | | 3.3V | | 3.25 | 3.3 | 3.35 | |
| | | 5V | | 4.95 | 5 | 5.05 | |
| | | 12V | | 11.85 | 12 | 12.15 | |
| Output regulation | Line ($V_{I,min}$ to $V_{I,max}$) | 1.2V | | | 1 | | mV |
| | | 1.5V | | | 1 | | |
| | | 1.8V | | | 1 | | |
| | | 2.5V | - | - | 1 | - | |
| | | 3.3V | | | 1 | | |
| | | 5V | | | 4 | | |
| | | 12V | | | 9 | | |

| Parameter | Device | Symbol | Min | Typ | Max | Unit |
|--|--|--------|------|------|-----|------|
| Load ($I_{o,min}$ to $I_{o,max}$) | 1.2V | - | - | 1 | - | mV |
| | 1.5V | | | 1 | | |
| | 1.8V | | | 1 | | |
| | 2.5V | | | 1 | | |
| | 3.3V | | | 1 | | |
| | 5V | | | 5 | | |
| | 12V | | | 5 | | |
| | Temperature ($T_c = -40\text{ }^\circ\text{C}$ to $+100\text{ }^\circ\text{C}$) | | | All | | |
| Rated output current | 1.2V, | I_o | 0 | - | 25 | A |
| | 1.5V | | | | 25 | |
| | 1.8V | | | | 25 | |
| | 2.5V | | | | 25 | |
| | 3.3V | | | | 20 | |
| | 5V | | | | 15 | |
| | 12V | | | | 6.3 | |
| Output current-limit inception (hiccup) | 1.2V | I_o | 28 | - | 35 | A |
| | 1.5V | | 28 | | | |
| | 1.8V | | 28 | | | |
| | 2.5V | | 28 | | | |
| | 3.3V | | 22 | | | |
| | 5V | | 16.5 | | | |
| | 12V | | 6.9 | | | |
| Efficiency ($V_i = V_{i,nom}$; $100\%I_{o,max}$; $T_A = 25^\circ\text{C}$) | 1.2V | - | - | 88 | - | % |
| | 1.5V | | | 87 | | |
| | 1.8V | | | 89 | | |
| | 2.5V | | | 90.5 | | |
| | 3.3V | | | 91 | | |
| | 5V | | | 92 | | |
| | 12V | | | 91 | | |
| Efficiency ($V_i = V_{i,nom}$; $50\%I_{o,max}$; $T_A = 25^\circ\text{C}$) | 1.2V | - | - | 87 | - | % |
| | 1.5V | | | 88 | | |
| | 1.8V | | | 88.5 | | |
| | 2.5V | | | 89.5 | | |
| | 3.3V | | | 91 | | |
| | 5V | | | 91 | | |
| | 12V | | | 90 | | |

Output Specifications (Cont)

| Parameter | | Device | Symbol | Min | Typ | Max | Unit |
|--|---|---|--------|-----|---|-----|-----------|
| Dynamic response ($\Delta I_o/\Delta t=1A/10\mu s$, $V_i=V_{i,nom}$; $T_a=25^\circ C$) | Load change from $I_o = 50\%$ to 75% to 50% $I_{o,max}$ | 1.2V 1.5V 1.8V 2.5V 3.3V 5V 12V | - | | 60 50 50 60 85 110 150 | | mV |
| | Peak deviation settling Time (to $V_{o,nom}$) | 1.2V 1.5V 1.8V 2.5V 3.3V 5V 12V | - | | 300 115 125 70 70 120 120 | - | μsec |
| Dynamic response ($\Delta I_o/\Delta t=1A/1\mu s$; $V_i=V_{i,nom}$; $T_a=25^\circ C$, additional 220 μF load capacitor) | Load change from $I_o=50\%$ to 75% to 50% $I_{o,max}$ | 1.2V 1.5V 1.8V 2.5V 3.3V 5V 12V | - | | 130 130 120 170 130 130 120 | - | mv |
| | Peak deviation settling time (to $V_{o,nom}$) | 1.2V 1.5V 1.8V 2.5V 3.3V 5V 12V | - | | 300 100 115 150 80 130 320 | - | μsec |
| Turn-On time ($I_o=I_{o,max}$; V_o within 1%) | | All | - | - | - | 20 | msec |
| Output voltage overshoot ($I_o=I_{o,max}$; $T_a=25^\circ C$) | | All | - | - | 0 | | % V_o |
| Switching frequency | | All | - | | 310 | | kHz |

Feature Specifications

| Parameter | | Device | Symbol | Min | Typ | Max | Unit |
|---|----------------|--------|----------------------|------|-----------|-----|-----------------|
| Enable pin voltage | Logic low | All | | -0.7 | - | 1.2 | V |
| | Logic high | All | | 3.5 | - | 12 | V |
| Enable pin current (leakage current, @10V) | Logic low | All | | - | - | 1.0 | mA |
| | Logic high | All | | - | - | - | μA |
| Output voltage adjustment range | | All* | - | 80 | - | 110 | %V _o |
| Output over-voltage (hiccup) | | 1.2V | V _{o,clamp} | 1.4 | - | 2.0 | V |
| | | 1.5V | | 1.8 | | 2.5 | |
| | | 1.8V | | 2.2 | | 3.0 | |
| | | 2.5V | | 3.0 | | 3.8 | |
| | | 3.3V | | 3.9 | | 5.0 | |
| | | 5V | | 6.0 | | 7.5 | |
| | | 12V | | 14.4 | | 18 | |
| Over-temperature protection (auto-recovery) | | All | | 110 | 120 | 135 | C |
| Under-voltage Lockout | Turn-on point | All | - | 31 | 34 | 36 | V |
| | Turn-off point | All | - | 30 | 33 | 35 | V |
| AVO75-48S12-6/D under-voltage lockout | Turn-on point | All | - | 34.8 | 37 | 38 | V |
| | Turn-off point | All | - | 33.8 | 35.5 | 37 | V |
| Isolation capacitance | | All | - | - | 1000 | - | PF |
| Isolation resistance | | All | - | 10 | - | - | MΩ |
| Calculated MTBF (I _o =I _{o,max} ; T _c =25°C) | | All | - | - | 2,500,000 | - | Hours |
| Weight | | All | - | - | - | 30 | g(oz.) |

Note: Output voltage adjustment rang of 12V module is 90% to 110%.

Characteristic Curves

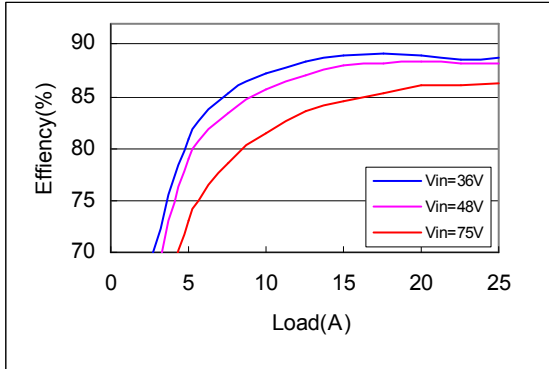

Fig. 1 Typical efficiency of AVO75-48S1V2

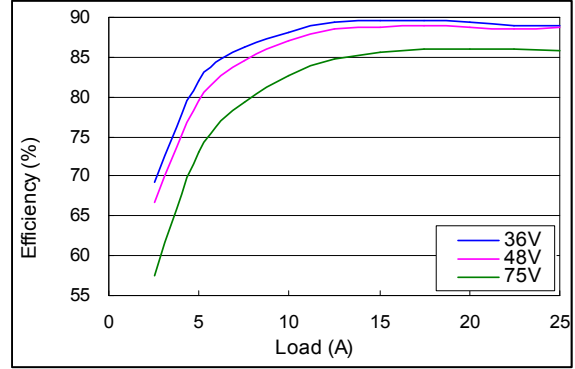

Fig. 2 Typical efficiency of AVO75-48S1V5

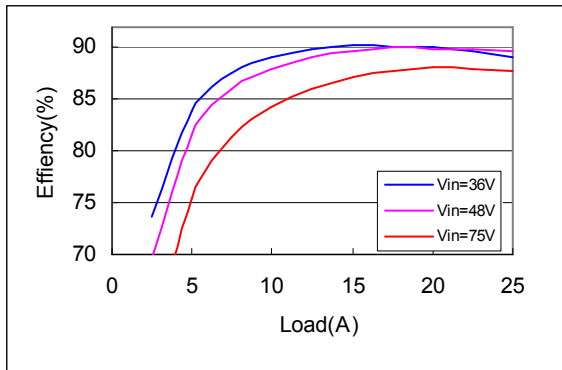

Fig. 3 Typical efficiency of AVO75-48S1V8

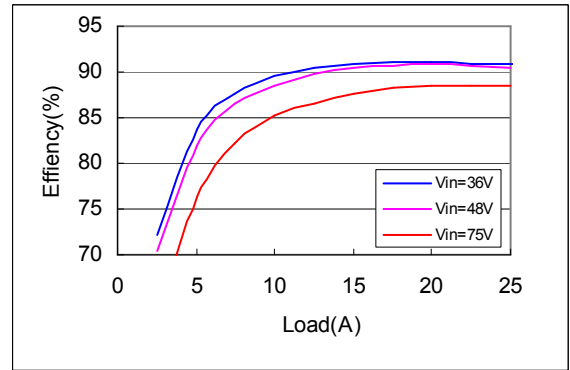

Fig. 4 Typical efficiency of AVO75-48S2V5

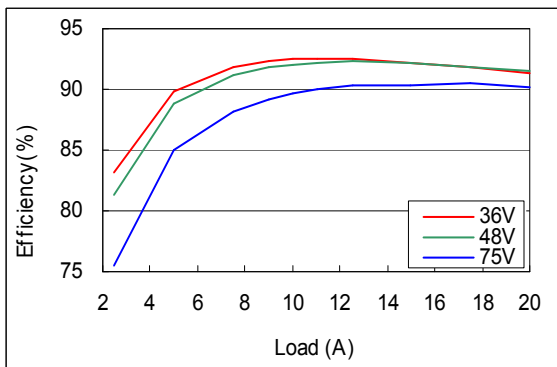

Fig. 5 Typical efficiency of AVO75-48S3V3

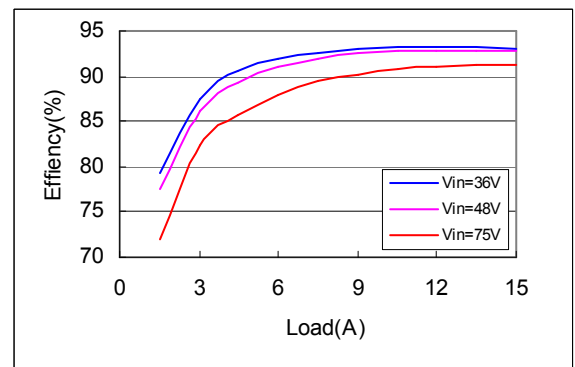

Fig. 6 Typical efficiency of AVO75-48S05

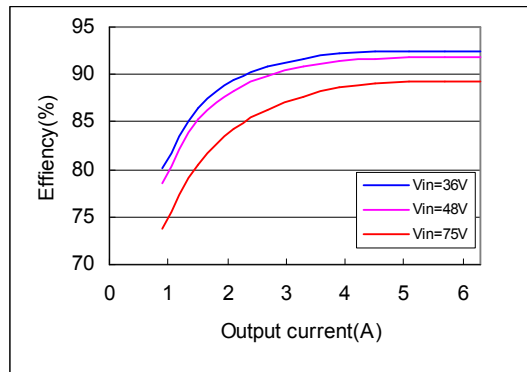

Fig. 7 Typical efficiency of AVO75-48S12

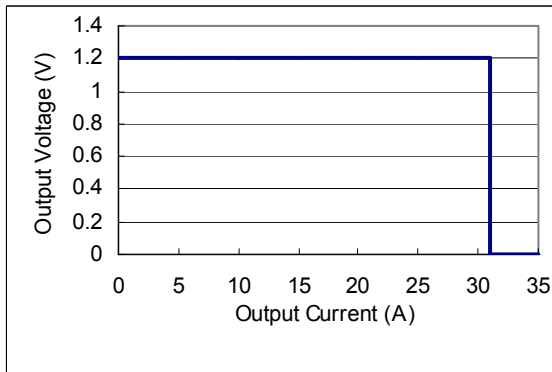

Fig. 8 Typical output over-current of AVO75-48S1V2

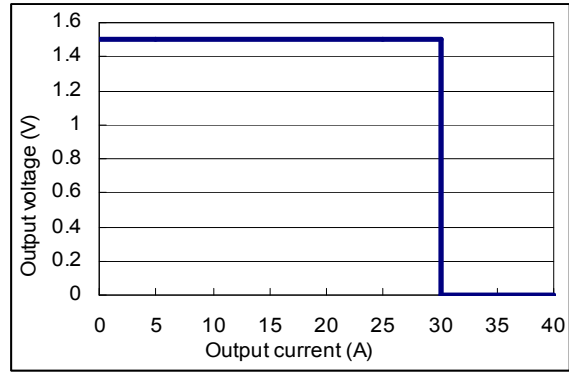

Fig. 9 Typical output over-current of AVO75-48S1V5

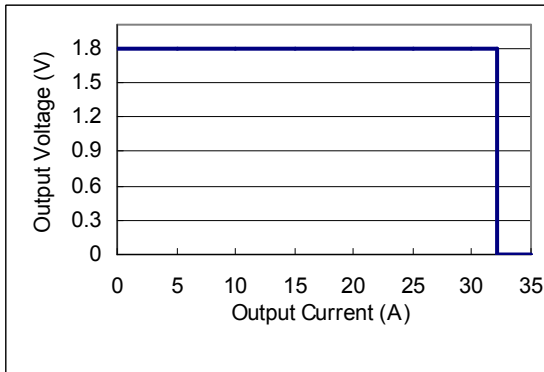

Fig. 10 Typical output over-current of AVO75-48S1V8

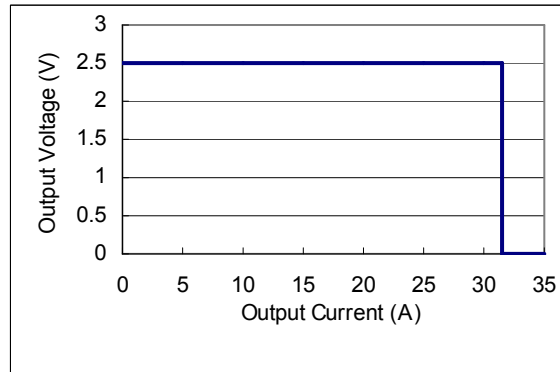

Fig. 11 Typical output over-current of AVO75-48S2V5

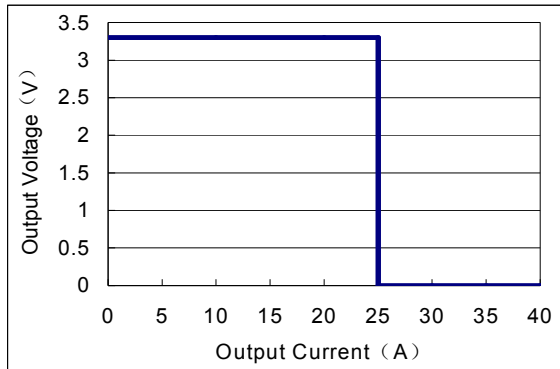

Fig. 12 Typical output over-current of AVO75-48S3V3

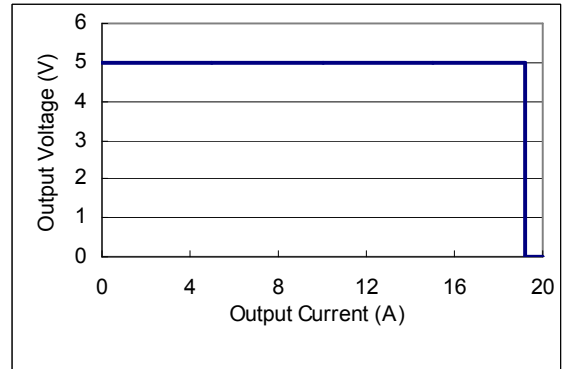

Fig. 13 Typical output over-current of AVO75-48S05

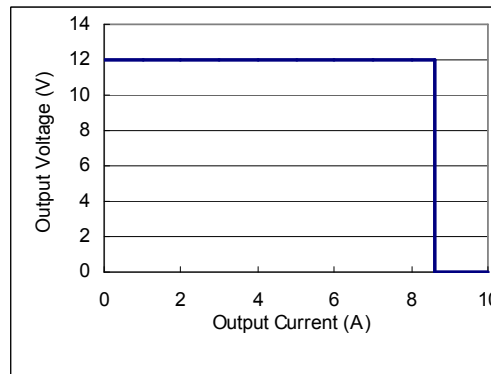

Fig. 14 Typical output over-current of AVO75-48S12

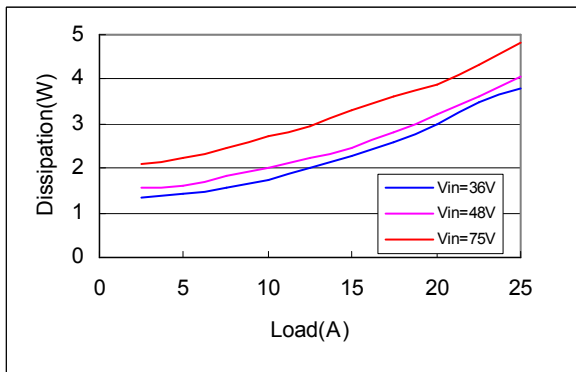

Fig. 15 Typical power dissipation of AVO75-48S1V2

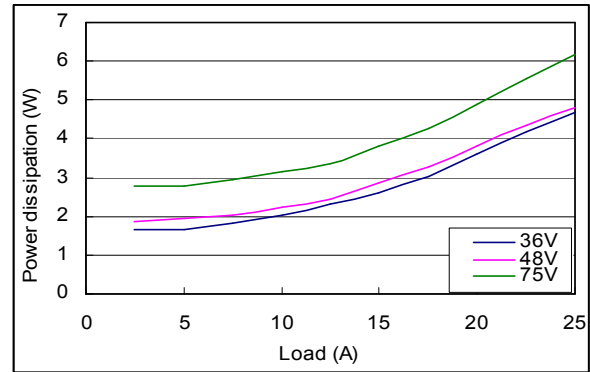

Fig. 16 Typical power dissipation of AVO75-48S1V5

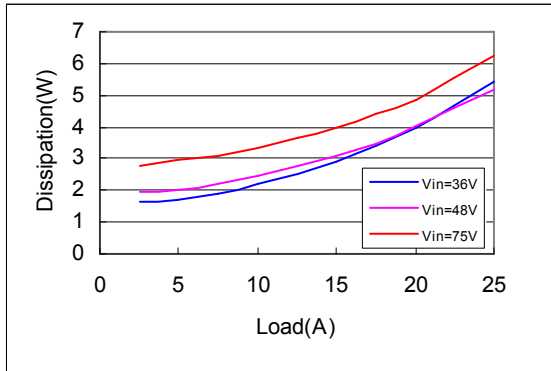

Fig. 17 Typical power dissipation of AVO75-48S1V8

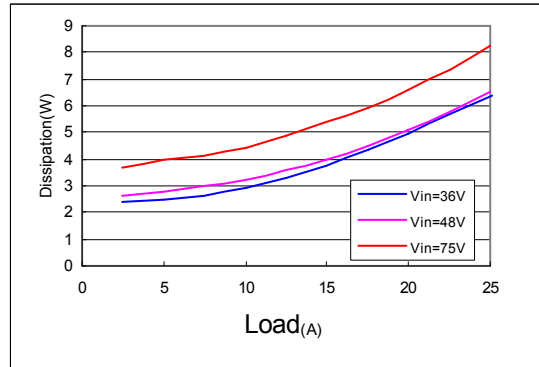

Fig. 18 Typical power dissipation of AVO75-48S2V5

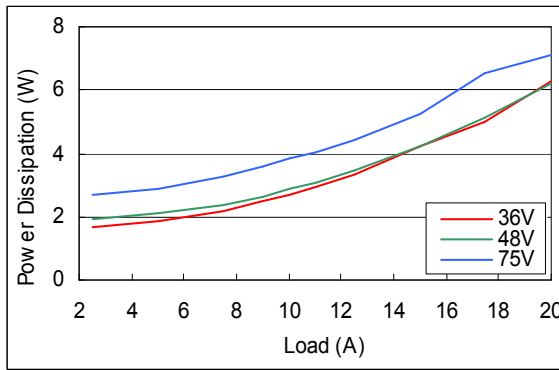

Fig. 19 Typical power dissipation of AVO75-48S3V3

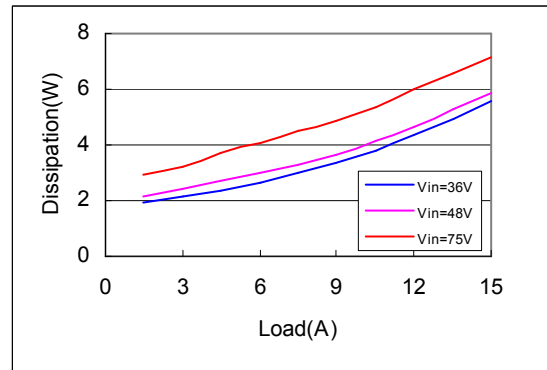

Fig. 20 Typical power dissipation of AVO75-48S05

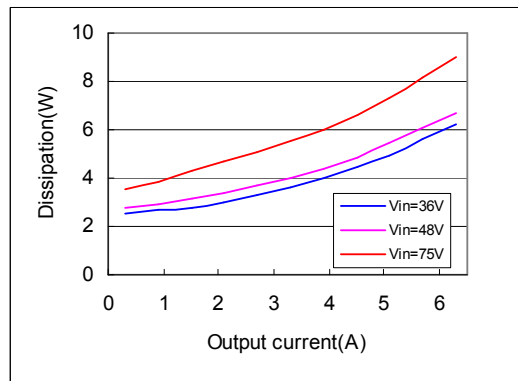

Fig. 21 Typical power dissipation of AVO75-48S12



Fig. 22 AVO75-48S1V2 typical transient response to step decrease in load from 50% to 25% of full load, room temperature, 48Vdc input



Fig. 23 AVO75-48S1V2 typical transient response to step increase in load from 50% to 75% of full load, room temperature, 48Vdc input



Fig. 24 AVO75-48S1V5 typical transient response to step decrease in load from 50% to 25% of full load, room temperature, 48Vdc input

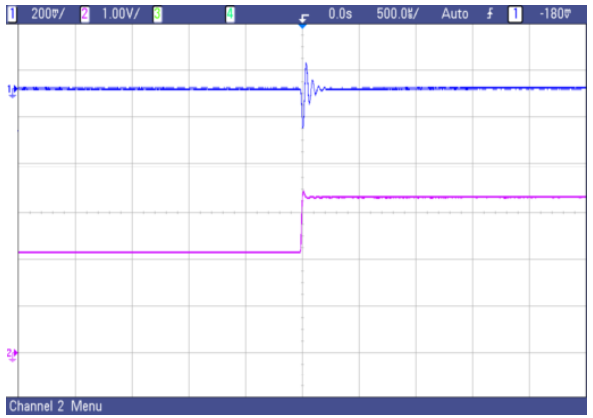

Fig. 25 AVO75-48S1V5 typical transient response to step increase in load from 50% to 75% of full load, room temperature, 48Vdc input ($\Delta I_o/\Delta t=1A/1\mu s$)

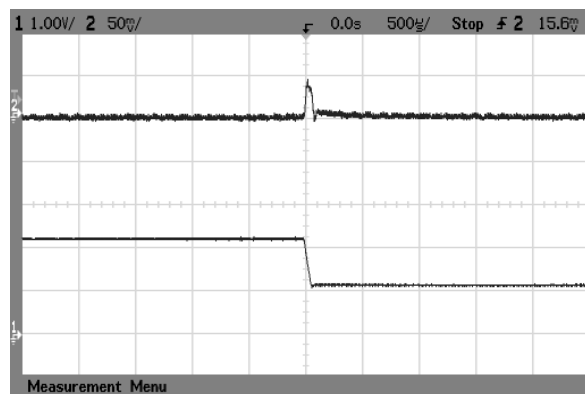

Fig. 26 AVO75-48S1V5 typical transient response to step decrease in load from 50% to 25% of full load, room temperature, 48Vdc input ($\Delta I_o/\Delta t=0.1A/1\mu s$)

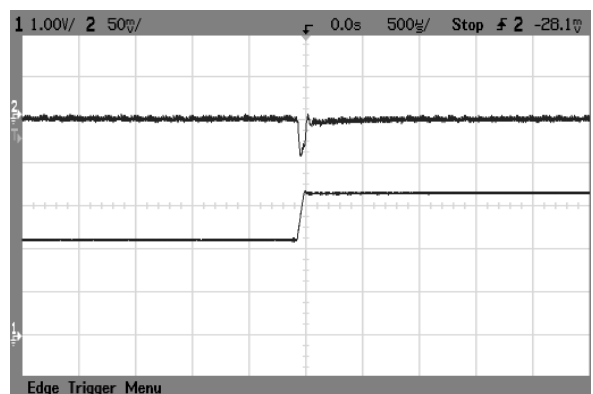

Fig. 27 AVO75-48S1V5 typical transient response to step increase in load from 50% to 75% of full load, room temperature, 48Vdc input ($\Delta I_o/\Delta t=0.1A/1\mu s$)

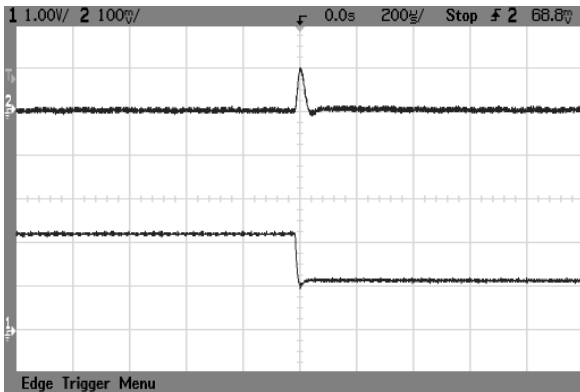

Fig. 28 AVO75-48S1V5 typical transient response to step decrease in load from 50% to 25% of full load, room temperature, 48Vdc input ($\Delta I_o/\Delta t=1A/1\mu s$)

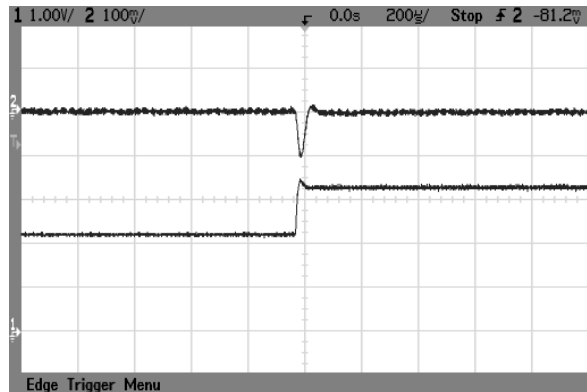

Fig. 29 AVO75-48S1V5 typical transient response to step increase in load from 50% to 75% of full load, room temperature, 48Vdc input ($\Delta I_o/\Delta t=1A/1\mu s$)



Fig. 30 AVO75-48S1V8 typical transient response to step decrease in load from 50% to 25% of full load, room temperature, 48Vdc input ($\Delta I_o/\Delta t=0.1A/1\mu s$)

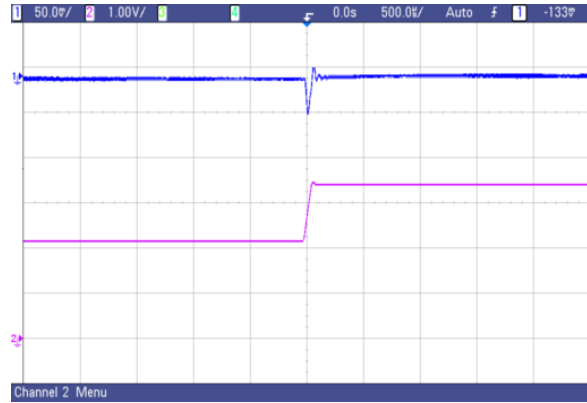

Fig. 31 AVO75-48S1V8 typical transient response to step increase in load from 50% to 75% of full load, room temperature, 48Vdc input ($\Delta I_o/\Delta t=0.1A/1\mu s$)



Fig. 32 AVO75-48S1V8 typical transient response to step decrease in load from 50% to 25% of full load, room temperature, 48Vdc input ($\Delta I_o/\Delta t=1A/1\mu s$)



Fig. 33 AVO75-48S1V8 typical transient response to step increase in load from 50% to 75% of full load, room temperature, 48Vdc input ($\Delta I_o/\Delta t=1A/1\mu s$)

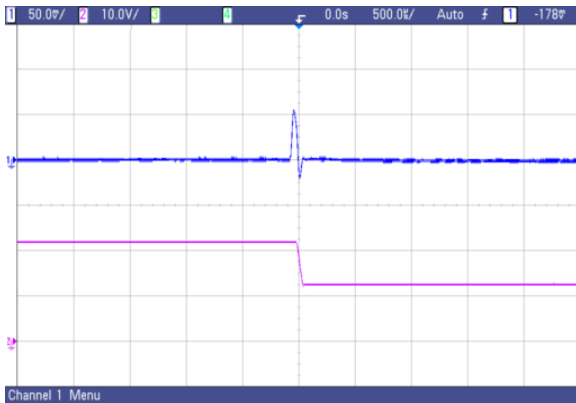

Fig. 34 AVO75-48S2V5 typical transient response to step decrease in load from 50% to 25% of full load, room temperature, 48Vdc input ($\Delta I_o/\Delta t=0.1A/1\mu s$)

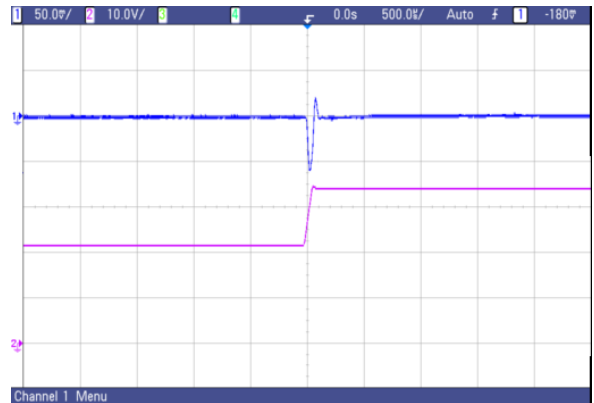

Fig. 35 AVO75-48S2V5 typical transient response to step increase in load from 50% to 75% of full load, room temperature, 48Vdc input ($\Delta I_o/\Delta t=0.1A/1\mu s$)

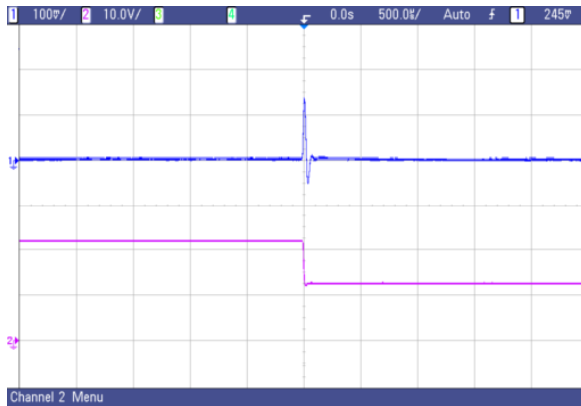

Fig. 36 AVO75-48S2V5 typical transient response to step decrease in load from 50% to 25% of full load, room temperature, 48Vdc input ($\Delta I_o/\Delta t=1A/1\mu s$)

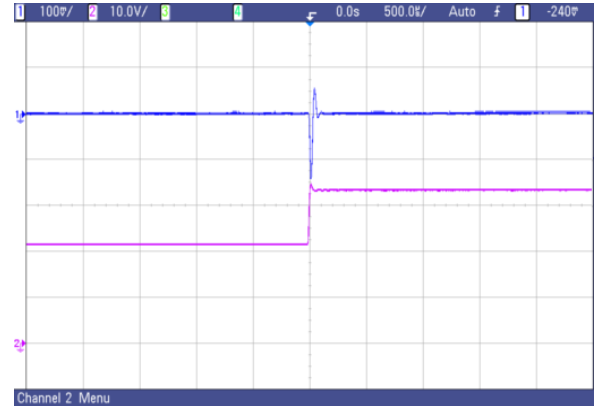

Fig. 37 AVO75-48S2V5 typical transient response to step increase in load from 50% to 75% of full load, room temperature, 48Vdc input ($\Delta I_o/\Delta t=1A/1\mu s$)

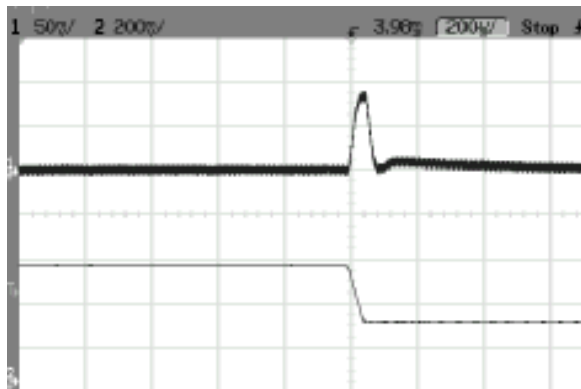

Fig. 38 AVO75-48S3V3 typical transient response to step decrease in load from 50% to 25% of full load, room temperature, 48Vdc input ($\Delta I_o/\Delta t=0.1A/1\mu s$)

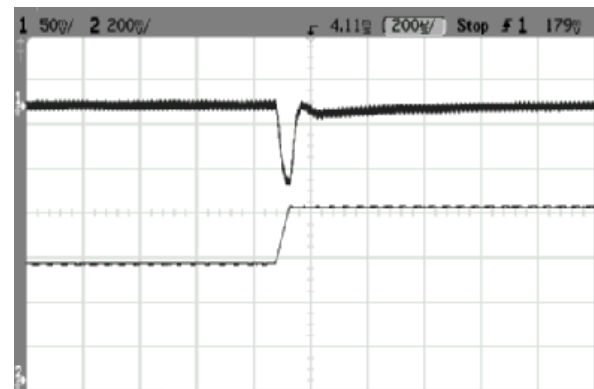

Fig. 39 AVO75-48S3V3 typical transient response to step increase in load from 50% to 75% of full load, room temperature, 48Vdc input ($\Delta I_o/\Delta t=0.1A/1\mu s$)

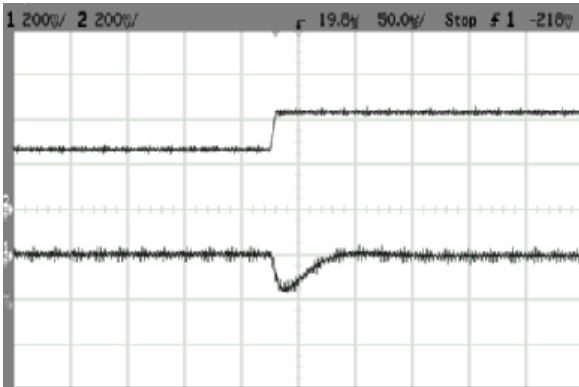

Fig. 40 AVO75-48S3V3 typical transient response to step decrease in load from 50% to 25% of full load, room temperature, 48Vdc input ($\Delta I_o/\Delta t=1A/1\mu s$)

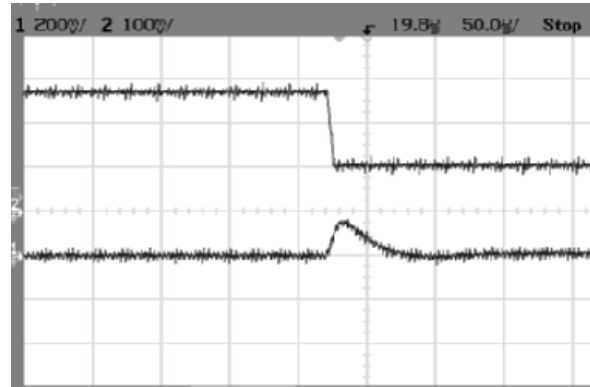

Fig. 41 AVO75-48S3V3 typical transient response to step increase in load from 50% to 75% of full load, room temperature, 48Vdc input ($\Delta I_o/\Delta t=1A/1\mu s$)

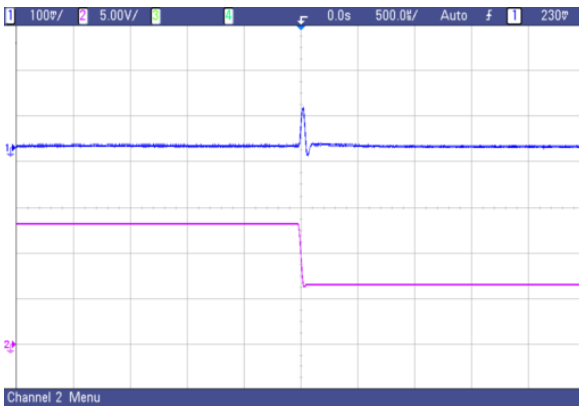

Fig. 42 AVO75-48S05 typical transient response to step decrease in load from 50% to 25% of full load, room temperature, 48Vdc input ($\Delta I_o/\Delta t=0.1A/1\mu s$)

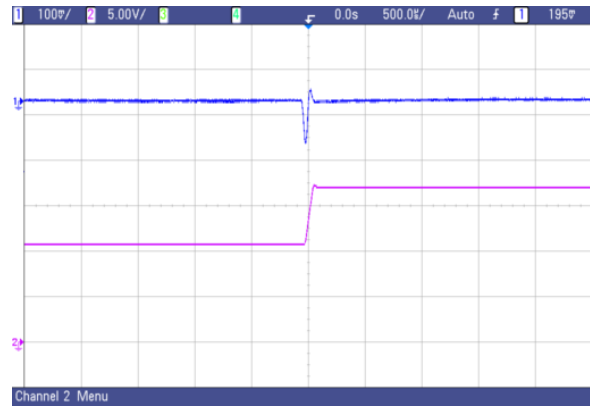

Fig. 43 AVO75-48S05 typical transient response to step increase in load from 50% to 75% of full load, room temperature, 48Vdc input ($\Delta I_o/\Delta t=0.1A/1\mu s$)

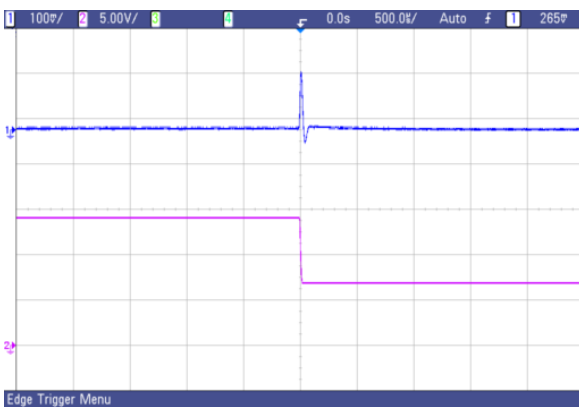

Fig. 44 AVO75-48S05 typical transient response to step decrease in load from 50% to 25% of full load, room temperature, 48Vdc input ($\Delta I_o/\Delta t=1A/1\mu s$)

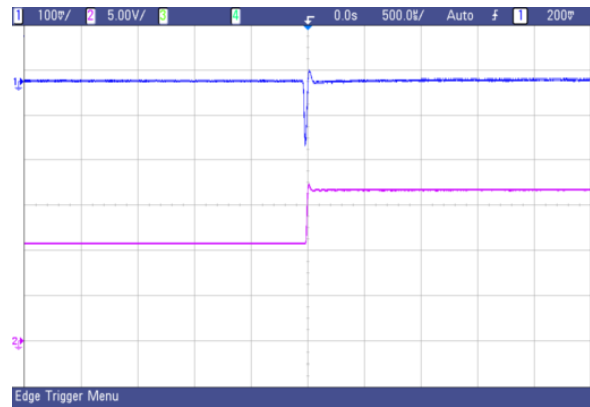

Fig. 45 AVO75-48S05 typical transient response to step increase in load from 50% to 75% of full load, room temperature, 48Vdc input ($\Delta I_o/\Delta t=1A/1\mu s$)

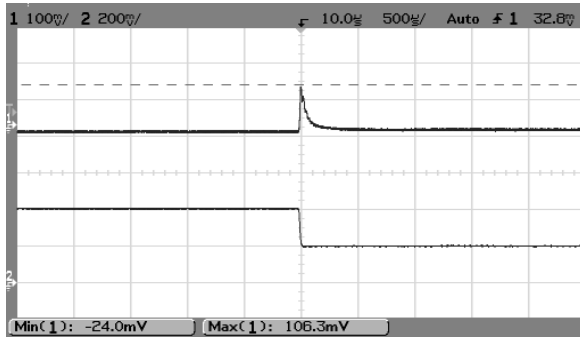

Fig. 46 AVO75-48S12 typical transient response to step decrease in load from 50% to 25% of full load, room temperature, 48Vdc input ($\Delta I_o/\Delta t=0.1A/1\mu s$)

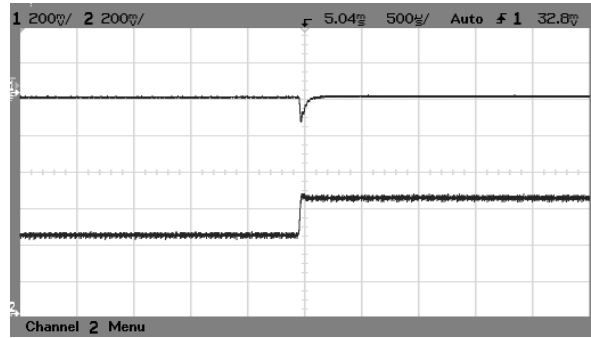

Fig. 47 AVO75-48S12 typical transient response to step increase in load from 50% to 75% of full load, room temperature, 48Vdc input ($\Delta I_o/\Delta t=0.1A/1\mu s$)

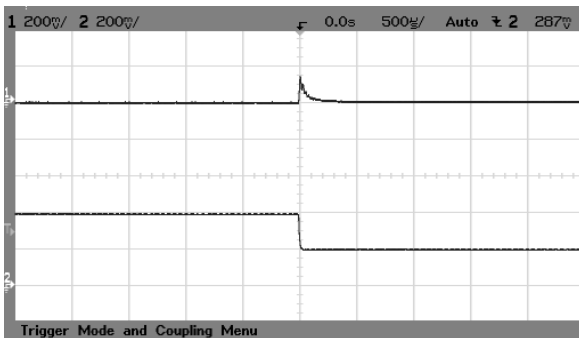

Fig. 48 AVO75-48S12 typical transient response to step decrease in load from 50% to 25% of full load, room temperature, 48Vdc input ($\Delta I_o/\Delta t=1A/1\mu s$)

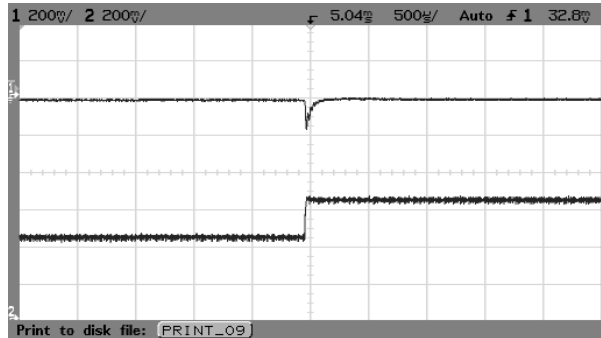

Fig. 49 AVO75-48S12 typical transient response to step increase in load from 50% to 75% of full load, room temperature, 48Vdc input ($\Delta I_o/\Delta t=1A/1\mu s$)

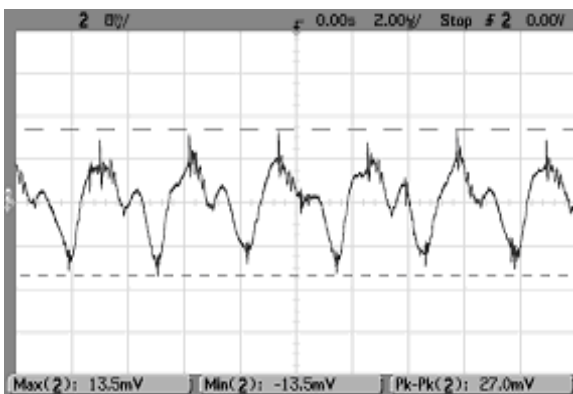

Fig. 50 Typical output ripple voltage of AVO75-48S1V2 room temperature, $I_o=I_{o,max}$

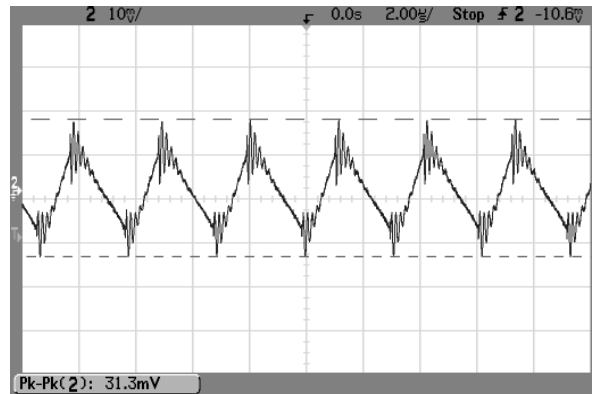

Fig. 51 Typical output ripple voltage of AVO75-48S1V5 room temperature, $I_o=I_{o,max}$

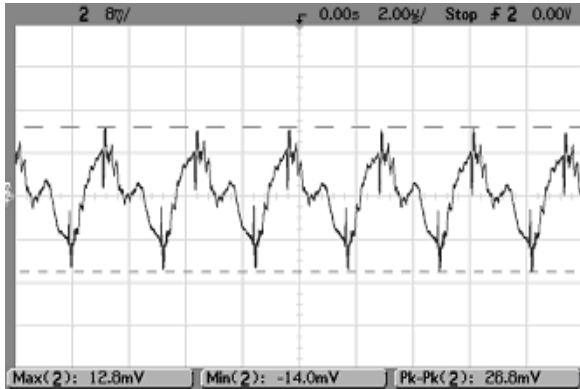

Fig. 52 Typical output ripple voltage of AVO75-48S1V8 room temperature, $I_o=I_{o,max}$

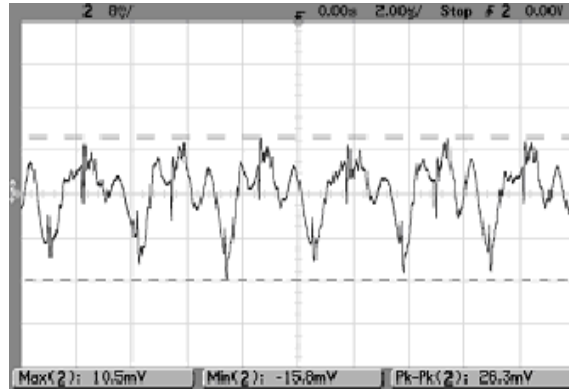

Fig. 53 Typical output ripple voltage of AVO75-48S2V5 room temperature, $I_o=I_{o,max}$

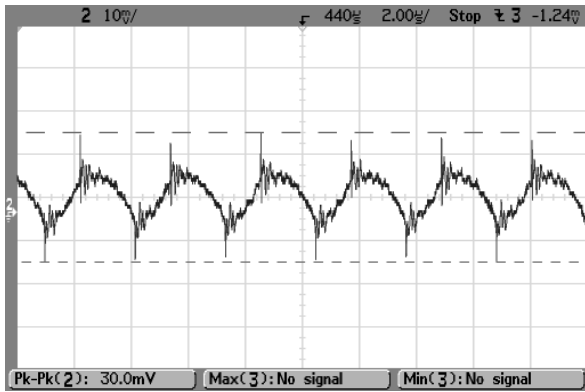

Fig. 54 Typical output ripple voltage of AVO75-48S3V3 room temperature, $I_o=I_{o,max}$

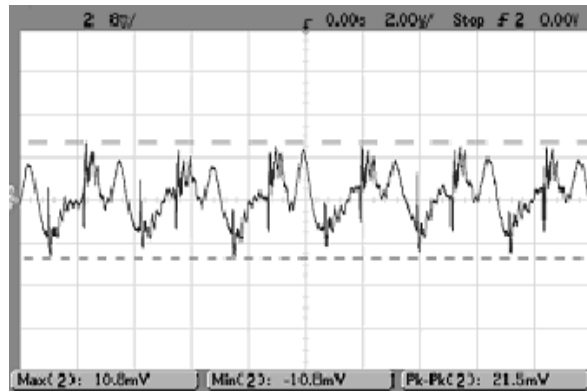

Fig. 55 Typical output ripple voltage of AVO75-48S05 room temperature, $I_o=I_{o,max}$

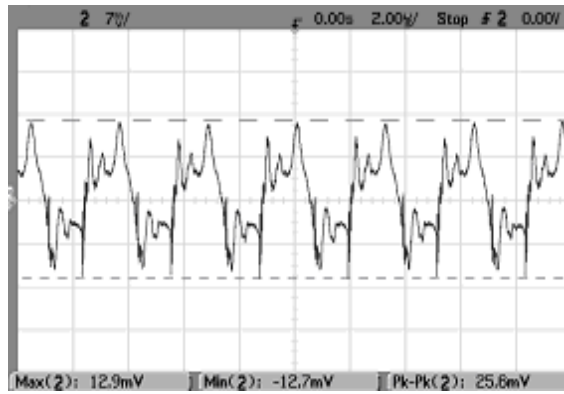

Fig. 56 Typical output ripple voltage of AVO75-48S12 room temperature, $I_o=I_{o,max}$

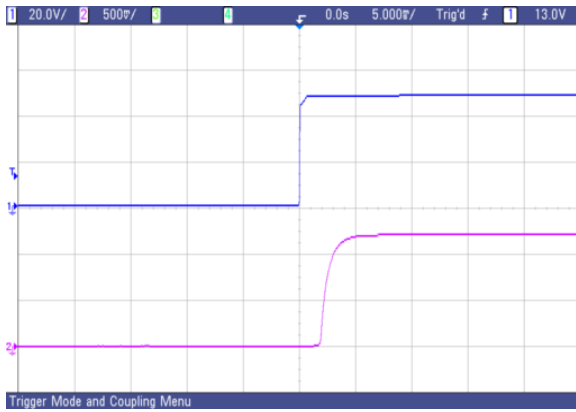

Fig. 57 AVO75-48S1V2 typical start-up from power on

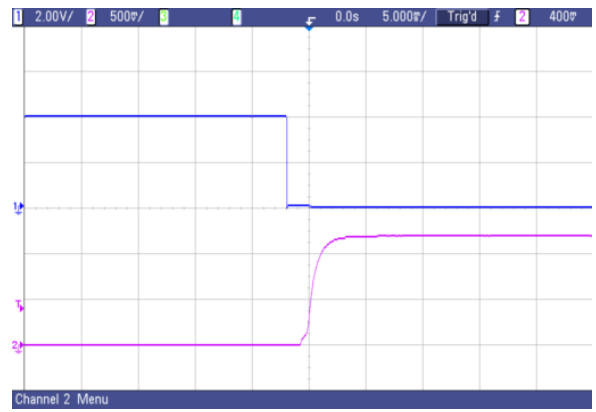

Fig. 58 AVO75-48S1V2 typical start-up from CNT on

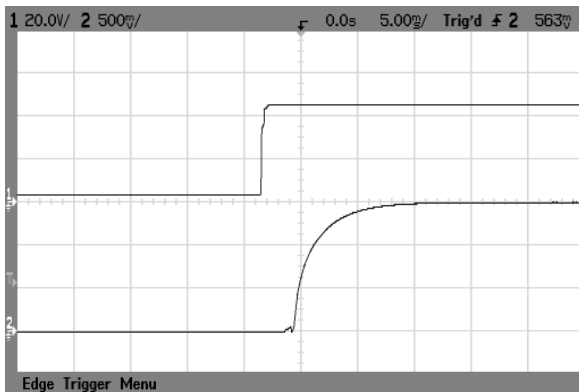

Fig. 59 AVO75-48S1V5 typical start-up from power on

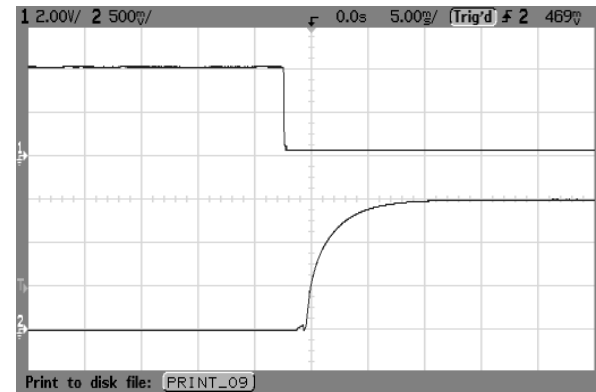

Fig. 60 AVO75-48S1V5 typical start-up from CNT on

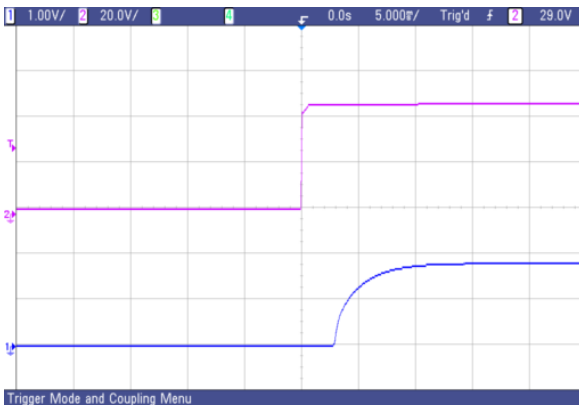

Fig. 61 AVO75-48S1V8 typical start-up from power on



Fig. 62 AVO75-48S1V8 typical start-up from CNT on

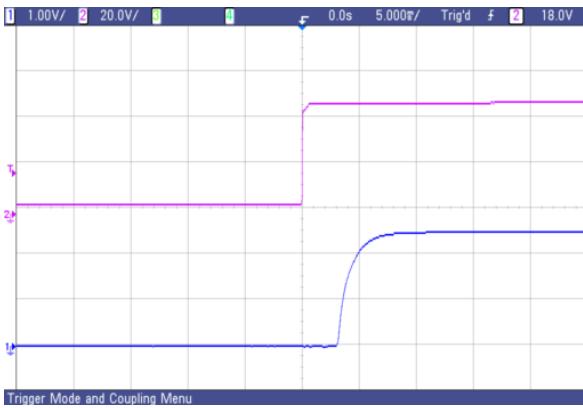

Fig. 63 AVO75-48S2V5 typical start-up from power on

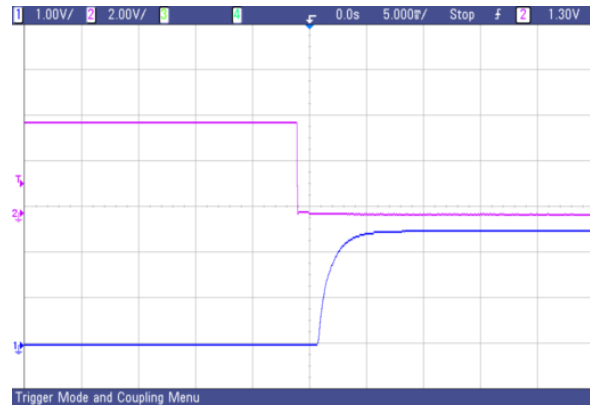

Fig. 64 AVO75-48S2V5 typical start-up from CNT on

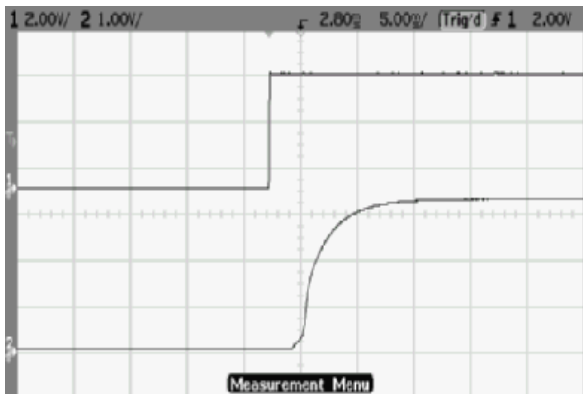

Fig. 65 AVO75-48S3V3 typical start-up from power on

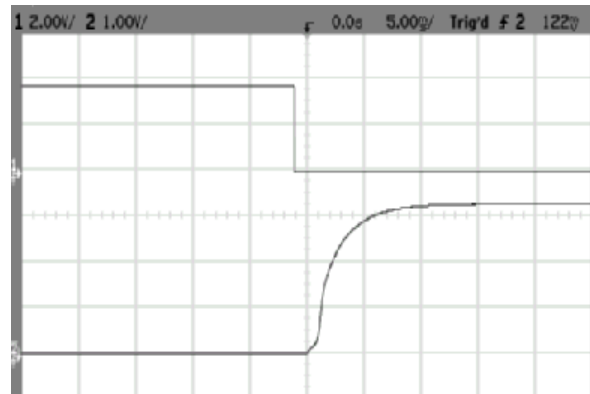

Fig. 66 AVO75-48S3V3 typical start-up from CNT on

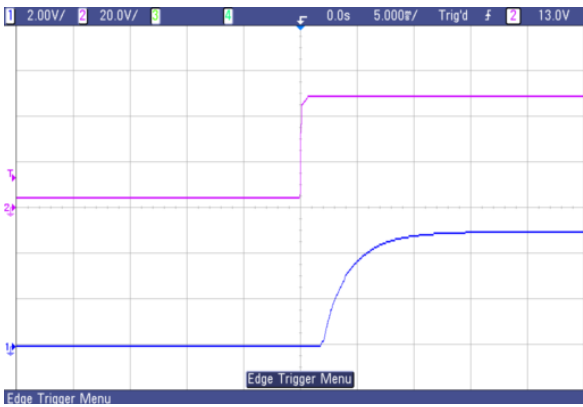

Fig. 67 AVO75-48S05 typical start-up from power on



Fig. 68 AVO75-48S05 typical start-up from CNT on

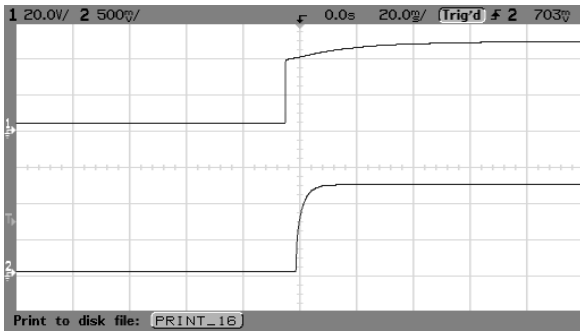

Fig. 69 AVO75-48S12 typical start-up from power on

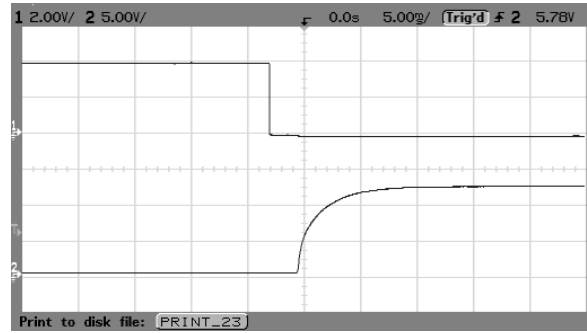

Fig. 70 AVO75-48S12 typical start-up from CNT on

Feature Description

CNT Function

The converter is equipped with a primary ON/OFF pin used to remotely turn the converter on or off via a system signal. Two CNT logic options are available. For the positive logic model a system logic low signal will turn the unit off. For the negative logic model a system logic high signal will turn the converter off. For negative logic models where no control signal will be used the ON/OFF pin should be connected directly to $-V_{in}$ to ensure proper operation. For positive logic models where no control signal will be used the ON/OFF pin should be left unconnected.

The following Fig. shows a few simple CNT circuits.

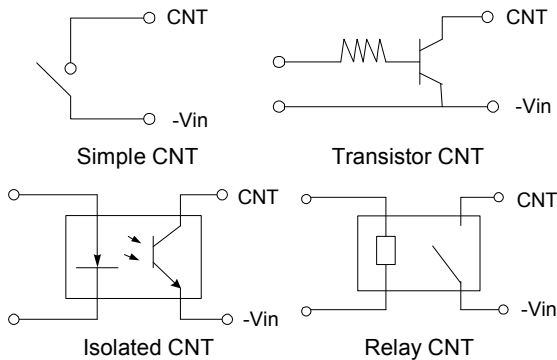

Fig. 71 CNT circuits

Remote Sense

The AVO75 converter can remotely sense both lines of its output which moves the effective output voltage regulation point from the output terminals of the unit to the point of connection of the remote sense pins. This feature automatically adjusts the real output voltage of the AVO75 in order to compensate for voltage

drops in distribution and maintain a regulated voltage at the point of load.

When the converter is supporting loads far away, or is used with undersized cabling, significant voltage drop can occur at the load. The best defense against such drops is to locate the load close to the converter and to ensure adequately sized cabling is used. When this is not possible, the converter can compensate for a drop of up to 10% V_o , through use of the sense leads.

When used, the + Sense and - Sense leads should be connected from the converter to the point of load as shown in Fig. 72, using twisted pair wire, or parallel pattern to reduce noise effect. The converter will then regulate its output voltage at the point where the leads are connected. Care should be taken not to reverse the sense leads. If reversed, the converter will trigger OVP protection.

When not used, the +Sense lead must be connected with $+V_o$, and -Sense with $-V_o$. Although the output voltage can be increased by both the remote sense and by the trim, the maximum increase for the output voltage is not the sum of both.

The maximum increase is the larger of either the remote sense or the trim.

Note that at elevated output voltages the maximum power rating of the module remains the same, and the output current capability will decrease correspondingly.

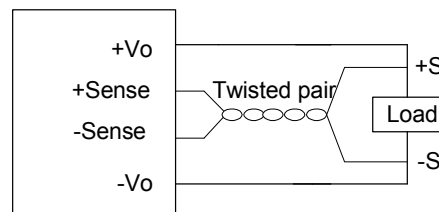

Fig. 72 Sense connections

Trim

The +Vo output voltage of the AVO75 series can be trimmed with the trim pin provided. Applying a resistor to the trim pin through a voltage divider from the output will cause the +Vo output to increase by up to 10% or decrease by up to 20%. Trimming up by more than 10% of the nominal output may activate the OVP circuit or damage the converter. Trimming down more than 20% can cause the converter to regulate improperly. If the trim pin is not needed, it should be left open.

Trim up

With an external resistor connected between the TRIM and +SENSE pins, the output voltage set point increases (see Fig. 73).

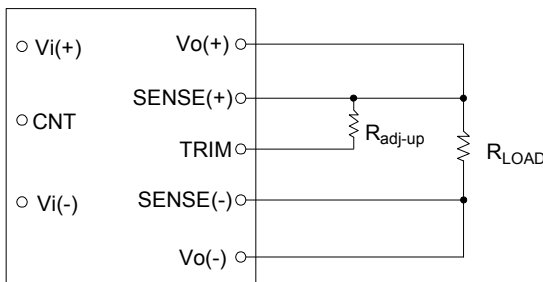

Fig. 73 Trim up circuit

The following equation determines the required external-resistor value to obtain a percentage output voltage change of 1%.

For Output Voltage: 1.5V ~ 12V

$$R_{adj-up} = \frac{5.1 \times V_{nom} \times (100 + \Delta\%)}{1.225 \times \Delta\%} - \frac{510}{\Delta\%} - 10.2(k\Omega)$$

For output voltage: 1.2V

$$R_{adj-up} = \frac{5.1 \times V_{nom} \times (100 + \Delta\%)}{0.6 \times \Delta\%} - \frac{510}{\Delta\%} - 10.2(k\Omega)$$

Note: $\Delta = (V_{nom} - V_o) \times 100 / V_{nom}$

V_{trim} tolerance: < $\pm 2\%$,

R_{adj} tolerance: $\pm 1\%$

For example: trim up the output of AVO75-48S1V8 to 1.98V.

$$\Delta = (1.98 - 1.8) \times 100 / 1.8 = 10$$

$$R_{adj-up} = \frac{5.1 \times 1.8 \times (100 + 10)}{1.225 \times 10} - \frac{510}{10} - 10.2(k\Omega)$$

$$R_{adj-up} = 21.23(k\Omega)$$

Trim down

With an external resistor between the TRIM and -SENSE pins, the output voltage set point decreases (see Fig. 74).

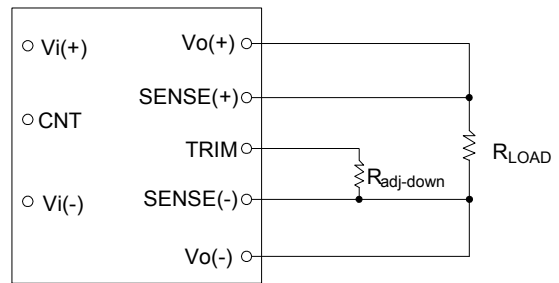

Fig. 74 Trim down circuit

The following equation determines the required external-resistor value to obtain a percentage output voltage change of 1%.

For output voltage: 1.2V ~ 12V

$$R_{adj-down} = \frac{510}{\Delta\%} - 10.2(k\Omega)$$

Note: $\Delta = (V_{nom} - V_o) \% 100 / V_{nom}$

V_{trim} tolerance: < $\pm 2\%$,

R_{adj} tolerance: $\pm 1\%$

For example: trim down the output of AVO75-48S1V8 to 1.62V.

$$\Delta = (1.8 - 1.62) \times 100 / 1.8 = 10$$

$$R_{adj-down} = \frac{510}{10} - 10.2(k\Omega)$$

$$R_{adj-down} = 40.8(k\Omega)$$

Although the output voltage can be increased by both the remote sense and by the trim, the maximum increase for the output voltage is not the sum of both. The maximum increase is the larger of either the remote sense or the trim.

Note that at elevated output voltages the maximum power rating of the module remains the same, and the output current capability will decrease correspondingly.

Minimum Load Requirements

There is no minimum load requirement for the AVO75 series modules.

Output Capacitance

High output current transient rate (high di/dt) of changing loads might require high values of output capacitance to supply the instantaneous energy requirement to the load. To minimize the output voltage transient drop during this transient, low Equivalent Series Resistance (ESR) capacitors may be required, since a high ESR will produce a correspondingly higher voltage drop during the current transient.

When the load is sensitive to ripple and noise, an output filter can be added to minimize the effects. A simple output filter to reduce output ripple and noise can be made by connecting a capacitor C1 across the output as shown in Fig.75. The recommended value for the output capacitor C1 is 470µF.

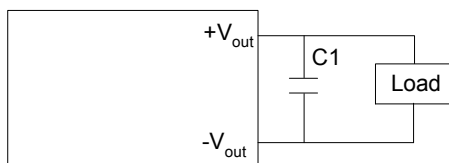

Fig. 75 Output ripple filter

Extra care should be taken when long leads or traces are used to provide power to the load. Long lead lengths increase the chance for noise to appear on the lines. Under these conditions C1 can be added across the load, with a 1µF ceramic capacitor C2 in parallel generally as shown in Fig. 76.

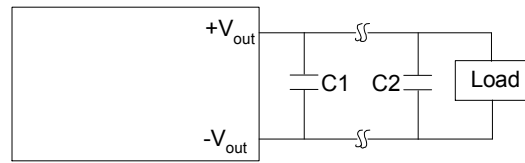

Fig. 76 Output ripple filter for a distant load

Decoupling

Noise on the power distribution system is not always created by the converter. High speed analog or digital loads with dynamic power demands can cause noise to cross the power inductor back onto the input lines. Noise can be reduced by decoupling the load. In most cases, connecting a 10µF tantalum or ceramic capacitor in parallel with a 0.1µF ceramic capacitor across the load will decouple it. The capacitors should be connected as close to the load as possible.

Ground Loops

Ground loops occur when different circuits are given multiple paths to common or earth ground, as shown in Fig.77. Multiple ground points can give slightly different potentials and cause current flow through the circuit from one point to another. This can result in additional noise in all the circuits. To eliminate the problem, circuits should be designed with a single ground connection as shown in Fig.78.

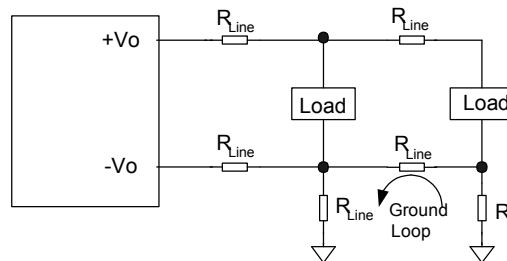

Fig. 77 Ground loops

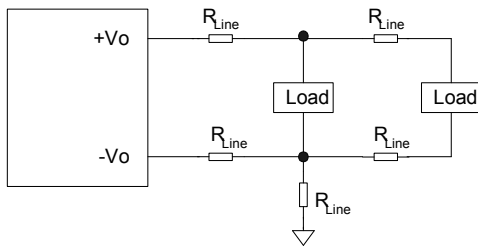

Fig. 78 Single point ground

Output Over-current Protection

AVO75 series DC/DC converters feature foldback current limiting as part of their Over-current Protection (OCP) circuits. When output current exceeds 110 to 140% of rated current, such as during a short circuit condition, the module will work on intermittent mode, also can tolerate short circuit conditions indefinitely. When the over-current condition is removed, the converter will automatically restart.

Output Over-Voltage Protection

The output over-voltage protection consists of circuitry that monitors the voltage on the output terminals. If the voltage on the output terminals exceeds the over voltage protection threshold, then the module will work on intermittent mode. When the over-voltage condition is removed, the converter will automatically restart.

The protection mechanism is such that the unit can continue in this condition until the fault is cleared.

Over-Temperature Protection

These modules feature an over-temperature protection circuit to safeguard against thermal damage. The module will work on intermittent mode when the maximum device reference temperature is exceeded. When the

over-temperature condition is removed, the converter will automatically restart.

Design Consideration

Typical Application

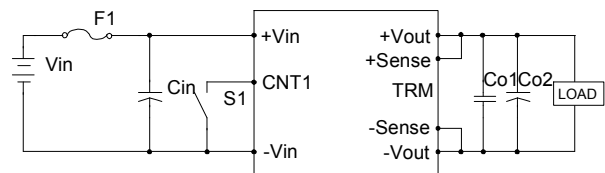

Fig. 79 Typical application

F1: Fuse. Use external fuse with a rating of 5A (fast blow type) for each unit.

Cin: Recommended input capacitor. Use 47 μ F/100V high frequency low ESR electrolytic type capacitor

Co1: Recommended 1 μ F/10V ceramic capacitor

Co2: Recommended output capacitor

Use 470 μ F/10V high frequency low ESR electrolytic type capacitor.

If $T_a < -5^\circ\text{C}$, use 220 μ F tantalum capacitor parallel with a 470 μ F/10V high frequency low ESR electrolytic capacitor.

Note: The AVO75 modules cannot be used in parallel mode directly!

Fusing

The AVO75 power modules have no internal fuse. An external fuse must always be employed! To meet international safety requirements, a 250 Volt rated fuse should be used. If one of the input lines is connected to chassis ground, then the fuse must be placed in the other input line.

Standard safety agency regulations require input fusing. Recommended fuse ratings is 5A for the AVO75 Series.

Note: the fuse is fast blow type.

Input Reverse Voltage Protection

Under installation and cabling conditions where reverse polarity across the input may occur, reverse polarity protection is recommended. Protection can easily be provided as shown in Fig. 80. In both cases the diode used is rated for 10A/100V. Placing the diode across the inputs rather than in-line with the input offers an advantage in that the diode only conducts in a

reverse polarity condition, which increases circuit efficiency and thermal performance.

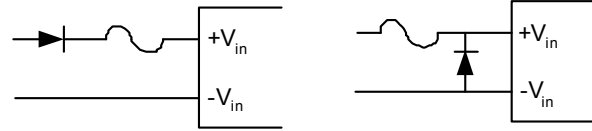

Fig. 80 Reverse polarity protection circuit

EMC

For conditions where EMI is a concern, a different input filter can be used. Fig. 81 shows a filter designed to reduce EMI effects. AVO75 series can meet EN55022 CLASS A shown Fig. 81.

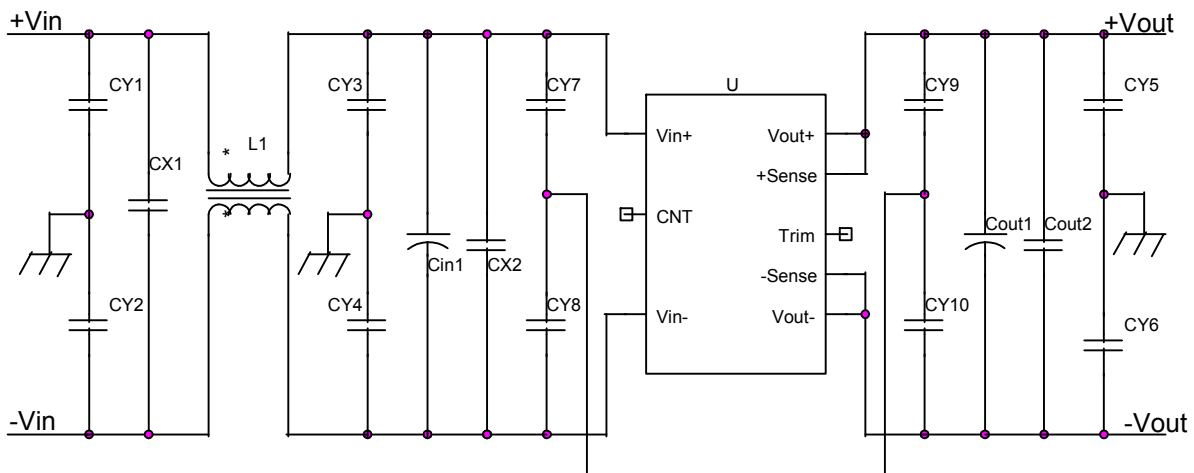

Fig. 81 EMI reduction filter

Recommended values:

| Component | Value/Rating | Component | Value/Rating |
|---------------------|---------------|-----------|-------------------------------|
| CY1, CY2, CY5, CY6 | 4700PF/250VAC | Cin1 | 47μF/100V |
| CX1 | 2.2μ/100V | CX2 | 1μF/100V |
| CY7, CY8, CY9, CY10 | 1000PF/250VAC | Cout1 | 470μF/10V (low ESR capacitor) |
| CY3, CY4 | 0.47μ | Cout2 | 1μF/10V |
| | | L1 | 1.8mH |

Safety Consideration

For safety-agency approval of the system in which the power module is used, the power module must be installed in compliance with the spacing and separation requirements of the end-use safety agency standard, i.e., UL1950, CSA C22.2 No. 950-95, and EN60950. The AVO75 series input-to-output isolation is a basic insulation. The DC/DC power module should be installed in end-use equipment, in compliance with the requirements of the ultimate application, and is intended to be supplied by an isolated secondary circuit. When the supply to the DC/DC power module meets all the requirements for SELV(<60Vdc), the output is considered to remain within SELV limits (level 3). If connected to a 60Vdc power system, double or reinforced insulation must be provided in the power supply that isolates the input from any hazardous voltages, including the AC mains. One input pin and one output pin are to be grounded or both the input and output pins are to be kept floating. Single fault testing in the power supply must be performed in combination with the DC/DC power module to demonstrate that the output meets the requirement for SELV. The input pins of the module are not operator accessible.

Note: Do not ground either of the input pins of the module, without grounding one of the output pins. This may allow a non-SELV voltage to appear between the output pin and ground.

Note:

To comply with the published safety standards, the following must be observed when using this built-in converter.

1. The built-in converter is intended for use as a component part of other equipment. When installing the power supply and marking input

and output connections, the relevant safety standards e.g. UL 60950-1; IEC 60950-1/VDE 0805; EN60950-1; CAN/CSA-22.2NO. 60950-1-03 must be complied with, especially the requirements for creepage distances, clearances and distance through insulation between primary and earth or primary and secondary.

2. The output power taken from the built-in converter must not exceed the rating given on the built-in converter.

3. The built-in converter is not intended to be repaired by service personnel in case of failure or component defect (unit can be thrown away).

4. The maximum ambient temperature around the converter must not exceed 55°C.

5. An external forced air cooling (CFM: 80.2, Speed: 1m/s, distance from unit: 20cm) shall be used for unit operate with full load and ambient up to 55°C.

6. The built-in converter has no in-line fuse. For safety purpose, a fast acting UL listed fuse or UL recognized fuse rated 5A/250V needs to be connected to the input side as external protection.

Thermal Consideration

Thermal management is an important part of the system design. AVO75 series modules have ultra high efficiency at full load, and the module exhibit good performance during pro-longed exposure to high temperatures. However, to ensure proper and reliable operation, sufficient cooling of the power module and power derating is needed over the entire temperature range of the module. Considerations includes ambient temperature, airflow and module power derating.

Measuring the thermal reference point of the module as the method shown in Fig. 82 can verify the proper cooling.

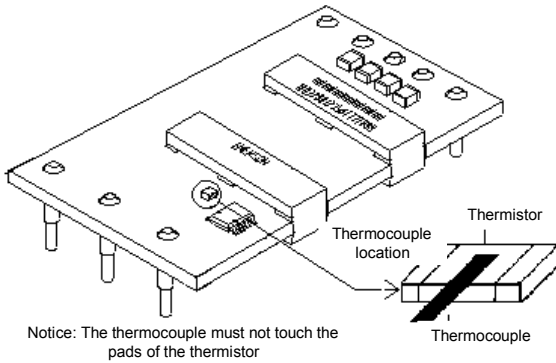

Fig. 82 Temperature measurement location

Module Derating

With 48V input, 55°C ambient temperature, and 200LFM airflow, AVO75 series are rated for full power. For operation above ambient temperature of 55°C, the output power must be derated as shown in Fig.83 to Fig.89. Meantime, airflow at least 200LFM over the converter must be provided to make the module working properly.

It is recommended that the temperature of the thermal reference point be measured using a thermocouple. Temperature on the PCB at the thermocouple location shown in Fig. 82 should not exceed 125°C in order to operate inside the derating curves as shown Fig. 83 to Fig 89.

The use of output power derating curve is shown in the following example.

Example

What is the minimum airflow necessary for a AVO75-48S3V3 operating at $V_I = 48V$, an output current of 20A, and a maximum ambient temperature of 55°C?

Solution

Given: $V_I=48V$, $I_o=20A$, $T_a=55^\circ C$

Determine airflow (v) (use Fig. 83 to Fig.89):
 $v=1m/s$. (200ft/min)

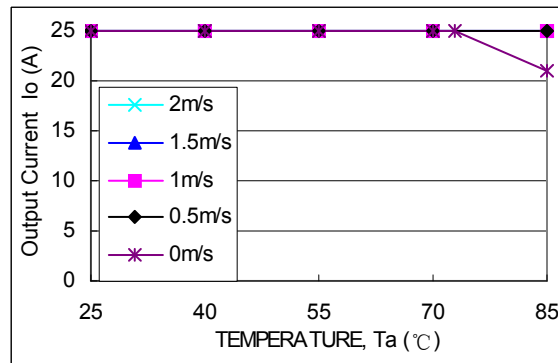

Fig. 83 AVO75-48S1V2 output power derating
Airflow direction from -Vin to +Vin; Vin=48V

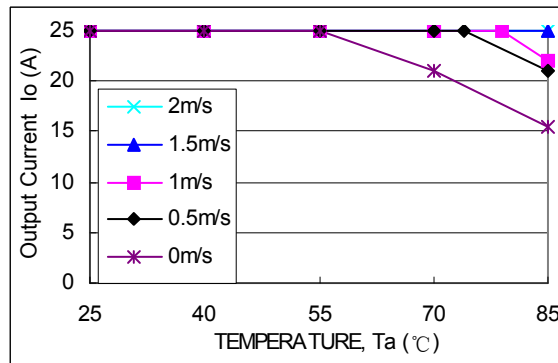

Fig. 84 AVO75-48S1V5 output power derating
Airflow direction from -Vin to +Vin; Vin=48V

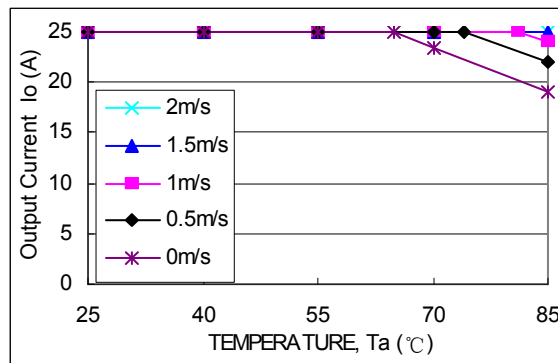

Fig. 85 AVO75-48S1V8 output power derating
Airflow direction from -Vin to +Vin; Vin=48V

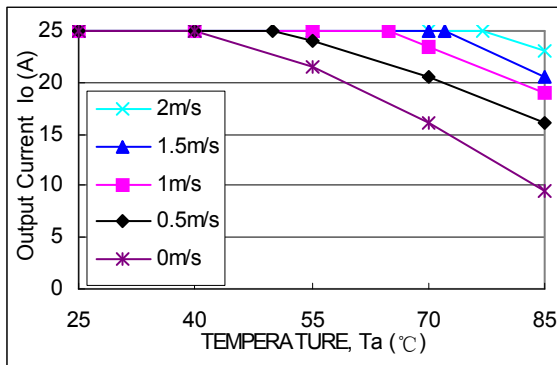

Fig. 86 AVO75-48S2V5 output power derating
Airflow direction from -Vin to +Vin; Vin=48V

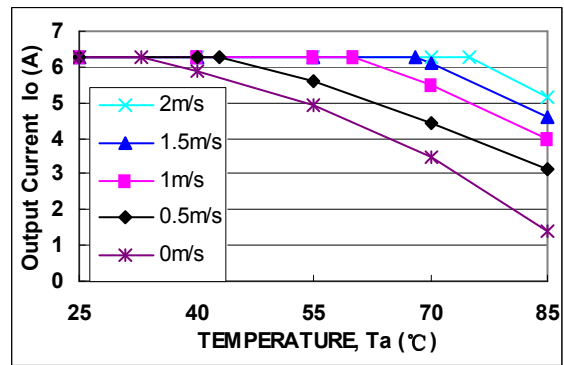

Fig. 89 AVO75-48S12 output power derating
Airflow direction from -Vin to +Vin; Vin=48V

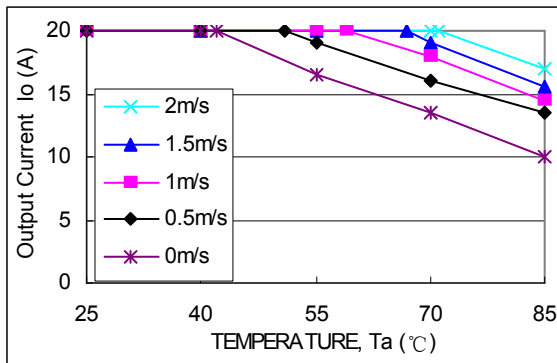

Fig. 87 AVO75-48S3V3 output power derating
Airflow direction from -Vin to +Vin; Vin=48V

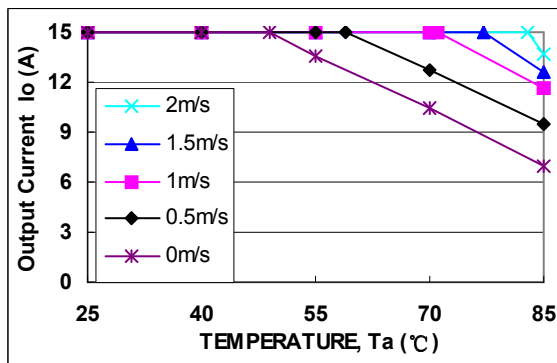

Fig. 88 AVO75-48S05 output power derating
Airflow direction from -Vin to +Vin; Vin=48V

MTBF

The MTBF, calculated in accordance with Bellcore TR-NWT-000332, is 2,500,000 hours. Obtaining this MTBF in practice is entirely possible. If the board temperature is expected to exceed +25°C, then we also advise an oriented for the best possible cooling in the air stream.

Emerson Network Power can supply replacements for converters from other manufacturers, or offer custom solutions. Please contact the factory for details.

Mechanical Considerations

Installation

Although AVO75 series converters can be mounted in any orientation, free air-flowing must be taken. Normally power components are always put at the end of the airflow path or have the separate airflow paths. This can keep other system equipment cooler and increase component life spans.

Soldering

AVO75 series converters are compatible with standard wave soldering techniques. When wave soldering, the converter pins should be preheated for 20 ~ 30 seconds at 110°C, and wave soldered at 260°C for less than 10 seconds.

When hand soldering, the iron temperature should be maintained at 425°C and applied to the converter pins for less than 5 seconds. Longer exposure can cause internal damage to the converter. Cleaning can be performed with cleaning solvent IPA or with water.

Mechanical Chart (Top & pin side view)

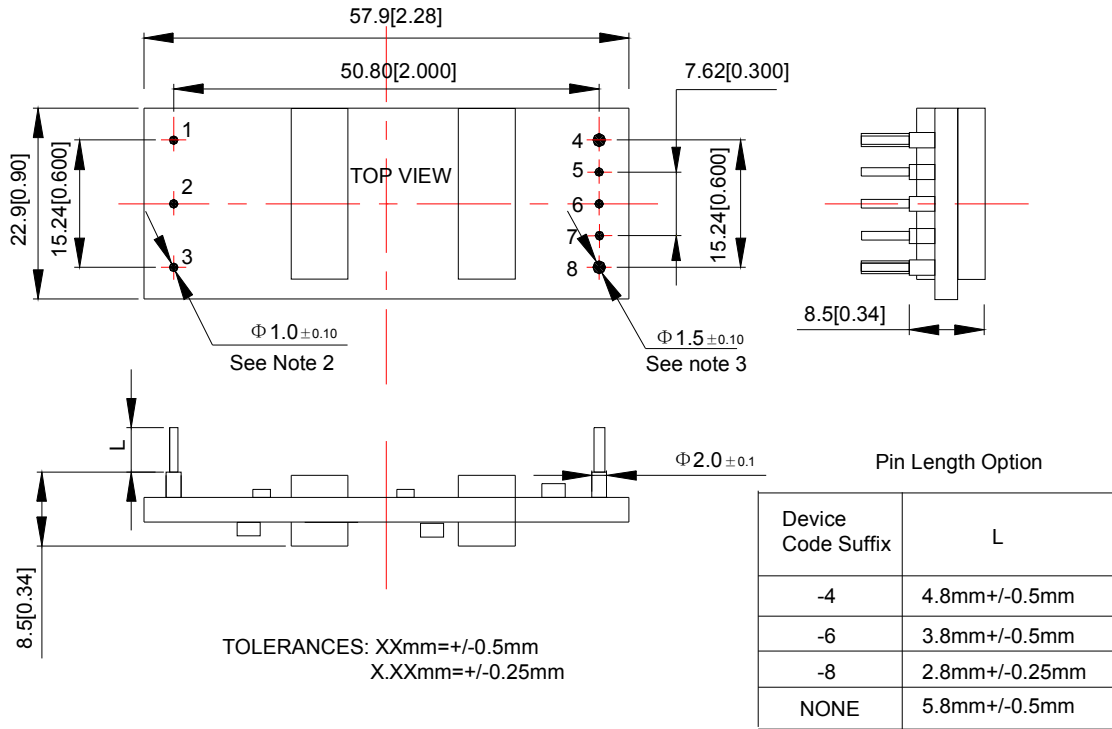

Notes:

- 1, Un-dimensioned components are for visual reference only.
- 2, Pins 1~3, 5~7 are 1.0mm diameter with 2.0mm diameter standoff shoulders.
- 3, Pins 4, 8 are 1.5mm diameter with no standoff shoulders.

| Pin No. | Function | Pin No. | Function |
|---------|----------|---------|----------|
| 1 | +Vin | 5 | +Sense |
| 2 | CNT | 6 | Trim |
| 3 | -Vin | 7 | -Sense |
| 4 | +Vo | 8 | -Vo |

Ordering Information

| Model number | Input voltage (V) | Output voltage (V) | Output current (A) | Ripple and noise (mV pp) | Efficiency (%) Typ. |
|--------------|-------------------|--------------------|--------------------|--------------------------|------------------------|
| | | | | Typ. | |
| AVO75-48S1V2 | 36~75 | 1.2 | 25 | 50 | 87 |
| AVO75-48S1V5 | 36~75 | 1.5 | 25 | 55 | 88 |
| AVO75-48S1V8 | 36~75 | 1.8 | 25 | 45 | 89 |
| AVO75-48S2V5 | 36~75 | 2.5 | 25 | 50 | 90 |
| AVO75-48S3V3 | 36~75 | 3.3 | 20 | 50 | 91 |
| AVO75-48S05 | 36~75 | 5 | 15 | 55 | 92 |
| AVO75-48S12 | 36~75 | 12 | 6.3 | 55 | 91 |

有毒有害物质或元素标识表

| 部件名称 | 有毒有害物质或元素 | | | | | |
|---|-----------|----|----|------------------|------|-------|
| | 铅 | 汞 | 镉 | 六价铬 | 多溴联苯 | 多溴联苯醚 |
| | Pb | Hg | Cd | Cr ⁶⁺ | PBB | PBDE |
| 制成板 | ○ | ○ | ○ | ○ | ○ | ○ |
| <p>○：表示该有毒有害物质在该部件所有均质材料中的含量在 SJ/T-11363-2006 规定的限量要求以下。</p> <p>×：表示该有毒有害物质至少在该部件的某一均质材料中的含量超出 SJ/T-11363-2006 规定的限量要求</p> <p>艾默生网络能源有限公司一直致力于设计和制造环保的产品，我们会通过持续的研究来减少和消除产品中的有毒有害物质。以下部件或应用中含有有毒有害物质是限于目前的技术水平无法实现可靠的替代或者没有成熟的解决方案：</p> <ol style="list-style-type: none"> 1. 焊料（含器件的高温焊料）中含有铅。 2. 电子器件的玻璃中含有铅。 3. 插针的铜合金中含有铅 <p>适用范围：AVO75 系列</p> | | | | | | |

Mouser Electronics

Authorized Distributor

Click to View Pricing, Inventory, Delivery & Lifecycle Information:

Emerson Network Power:

[AVO75-48S1V2P-4](#) [AVO75-48S2V5-4](#) [AVO75-48S2V5P-4](#) [AVO75-48S12P-4](#) [AVO75-48S05-6](#) [AVO75-48S1V8-4](#)
[AVO75-48S05P-4](#) [AVO75-48S1V8P-4](#) [AVO75-48S05-4](#) [AVO75-48S3V3-4](#) [AVO75-48S1V2-4](#)