

1 2 3 4 5

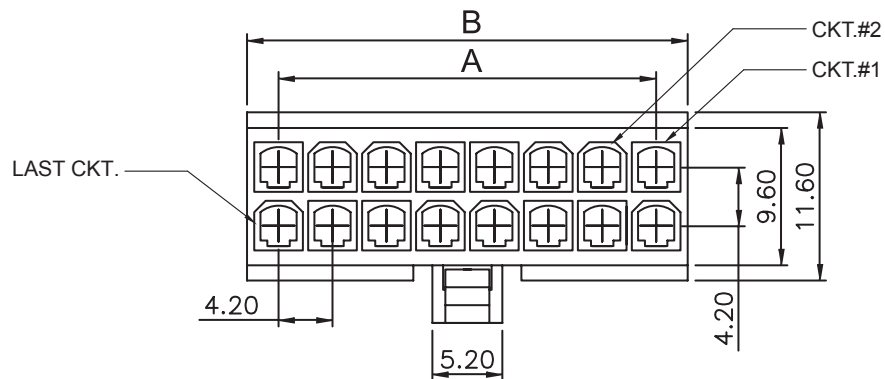

TECHNICAL CHARACTERISTICS

MATERIAL  
 INSULATOR: NYLON 66  
 FLAMMABILITY RATING: UL94-V0  
 COLOR: WHITE  
 PITCH: 4.20 MM

ENVIRONMENTAL  
 OPERATING TEMPERATURE: -40 UP TO 105°C  
 COMPLIANCE: LEAD FREE AND ROHS

ELECTRICAL  
 INSULATOR RESISTANCE: >1000 MOHM  
 DIELECTRIC WITHSTANDING VOLTAGE: 1500 VAC/MN

STANDARD  
 CERTIFIED: E323964

PACKAGING  
 BAG

DIMENSION  
 A = 4.20 x (NB. PIN / 2 - 1)  
 B = 4.20 x (NB. PIN / 2) + 1.20

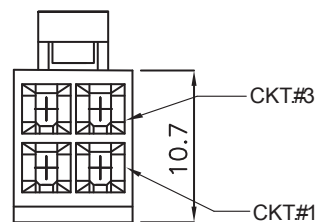
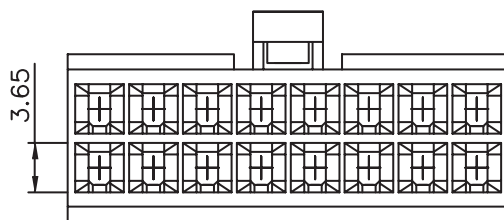
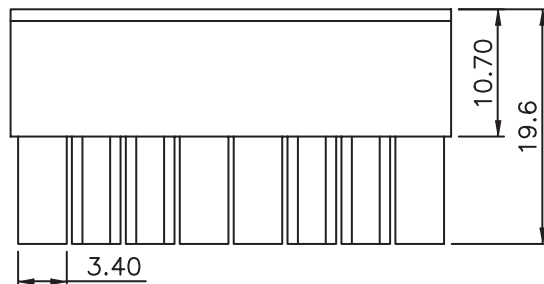
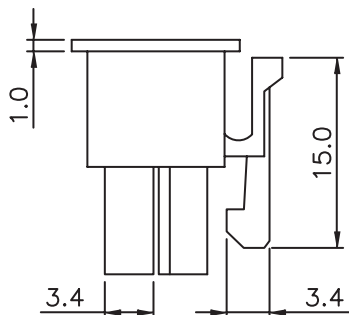

Dimensions for 4pins & 2pins connector

RoHS Compliant			
K	12-APR-17	TPK	AK
J	16-JAN-17	ELECTRICAL	AK
I	01-JUL-15	PINNING	AK
H	26-SEP-14	DRAWING	AS
REV	DATE	FILE	BY

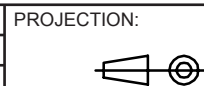

APPROVAL: BBu

GENERAL TOLERANCE

.X = +/- 0.2  
 .XX = +/- 0.15

UNIT: MM

SCALE:

SHEET: 1/3

DRAW: AS



DESCRIPTION: WR-MP 4.20MM FEMALE DUAL ROW RECEPTACLE

WERI PART NO: 649 0xx 113 322

SIZE

**A4**

A

B

C

D

1

2

3

4

5

Note:

1.Dimension:

Carton Size:40\*28\*28(cm)

2.Quantity:

Pin.	Pcs/Bag	Pcs/Carton	Pin.	Pcs/Bag	Pcs/Carton
2	1000	14000	14	100	2000
4	200	7600	16	100	1600
6	200	4800	18	100	1600
8	200	4000	20	100	1200
10	100	3000	22	100	1200
12	100	2600	24	100	1200

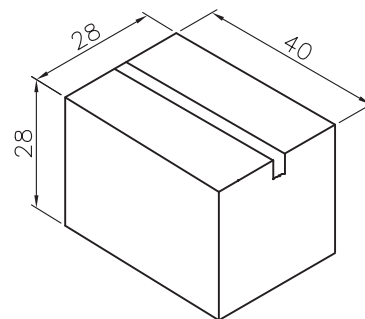
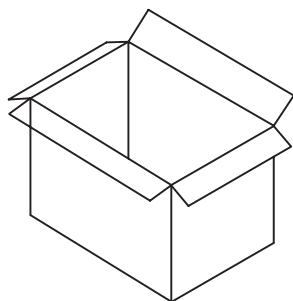
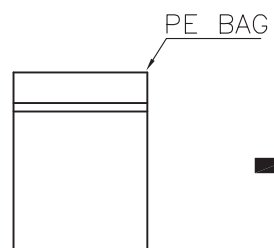

Carton

RoHS Compliant

PROJECTION:



GENERAL TOLERANCE

.X = +/- 0.2

.XX = +/- 0.15



APPROVAL: BBu

UNIT: MM

SCALE:

SHEET: 2/3

DRAW: PEARL

DESCRIPTION: 4.20MM FEMALE DUAL ROW RECEPTACLE

WERI PART NO: 649 0xx 113 322

SIZE

A4

REV	DATE	FILE	BY
G			
F			
E			
D			
C			
B			
A			

1

2

3

4

5

## Cautions and Warnings:

This electronic component is designed and developed with the intention for use in general electronics equipments.

Before incorporating the components into any equipments in the field such as aerospace, aviation, nuclear control, submarine, transportation, (automotive control, train control, ship control), transportation signal, disaster prevention, medical, public information network etc. where higher safety and reliability are especially required or if there is possibility of direct damage or injury to human body, Würth Elektronik must be asked for a written approval.



In addition, even electronic component in general electronic equipments, when used in electrical circuits that require high safety, reliability functions or performance, the sufficient reliability evaluation-check for the safety must be performed before by the user before usage.

A

B

C

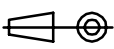
RoHS Compliant

G				PROJECTION: 	GENERAL TOLERANCE .X = +/- 0.2 .XX = +/- 0.15		
F							
E							
D							
C				APPROVAL: JC	UNIT: MM	DESCRIPTION: DISCLAIMER	SIZE <b>A4</b>
B					SCALE:		
A	10-SEP-14	PDF	QL		SHEET: 3/3	WERI PART NO: DISCLAIMER	
REV	DATE	FILE	BY		DRAW: QL		

D

# Mouser Electronics

Authorized Distributor

Click to View Pricing, Inventory, Delivery & Lifecycle Information:

## [Würth Electronics:](#)

[649010113322](#) [649002113322](#) [649004113322](#) [649008113322](#) [649006113322](#) [649022113322](#) [649018113322](#)  
[649012113322](#) [649016113322](#) [649014113322](#)