

# LP3850x-ADJ, LP3850xA-ADJ 3-A FlexCap Low Dropout Linear Regulator for 2.7-V to 5.5-V Inputs

## 1 Features

- Input Voltage: 2.7 V to 5.5 V
- Adjustable Output Voltage: 0.6 V to 5 V
- FlexCap: Stable with Ceramic, Tantalum, or Aluminum Capacitors
- Stable With 10- $\mu$ F Input and Output Capacitors
- Low Ground-Pin Current
- 25-nA Quiescent Current in Shutdown Mode
- Ensured Output Current of 3 A
- Ensured  $V_{ADJ}$  Accuracy of  $\pm 1.5\%$  at 25°C (A Grade)
- Ensured Accuracy of  $\pm 3.5\%$  at 25°C (STD)
- Overtemperature and Overcurrent Protection
- ENABLE (EN) Pin (LP38501 only)
- $-40^{\circ}\text{C}$  to  $+125^{\circ}\text{C}$  Operating Temperature Range

## 2 Applications

- ASIC Power Supplies In:
  - Printers, Graphics Cards, DVD Players
  - Set Top Boxes, Copiers, Routers
- DSP and FPGA Power Supplies
- SMPS Regulator
- Conversion from 3.3-V or 5-V Rail

## 3 Description

TI's FlexCap low-dropout (LDO) linear regulators feature unique compensation that allow use of any type of output capacitor with no limits on minimum or maximum equivalent series resistance (ESR). The LP38501 and LP38503 series of LDOs operate from a 2.7-V to 5.5-V input supply. These ultra-low-dropout linear regulators respond very quickly to step changes in load, making them suitable for low-voltage microprocessor applications. Developed on a CMOS process (utilizing a PMOS pass transistor) the LP38501-ADJ and LP38503-ADJ have low quiescent currents that change little with load current.

- GND Pin Current: Typically 2 mA at 3-A load current.
- Disable Mode: Typically 25-nA quiescent current when the EN pin is pulled low.
- Simplified Compensation: Stable with any type of output capacitor, regardless of ESR.
- Precision Output: A grade versions available with 1.5%  $V_{ADJ}$  tolerance (25°C) and 3% over line, load, and temperature.

### Device Information<sup>(1)</sup>

PART NUMBER	PACKAGE	BODY SIZE (NOM)
LP38501	DDPAK/TO-263 (5)	10.16 mm x 8.42 mm
LP38503	TO-263 (5)	10.16 mm x 9.85 mm

(1) For all available packages, see the orderable addendum at the end of the data sheet.

### Typical Application Circuits

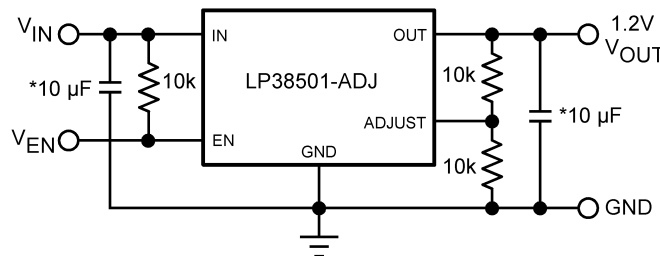

\*Minimum capacitance required (see [Application and Implementation](#)).

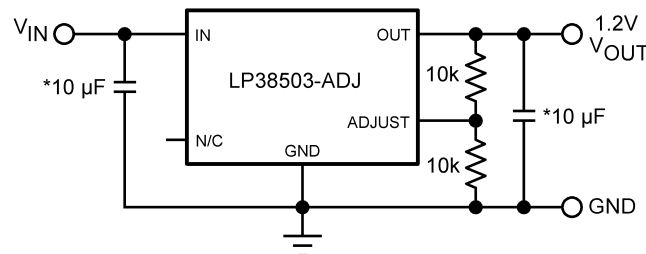

\*Minimum capacitance required (see [Application and Implementation](#)).



## Table of Contents

<b>1 Features</b> ..... 1 <b>2 Applications</b> ..... 1 <b>3 Description</b> ..... 1 <b>4 Revision History</b> ..... 2 <b>5 Pin Configurations and Functions</b> ..... 3 <b>6 Specifications</b> ..... 4 6.1 Absolute Maximum Ratings ..... 4 6.2 ESD Ratings ..... 4 6.3 Recommended Operating Conditions ..... 4 6.4 Thermal Information ..... 4 6.5 Electrical Characteristics ..... 5 6.6 Typical Characteristics ..... 7 <b>7 Detailed Description</b> ..... 9 7.1 Overview ..... 9 7.2 Functional Block Diagrams ..... 9 7.3 Feature Description ..... 9	7.4 Device Functional Modes ..... 14 <b>8 Application and Implementation</b> ..... 15 8.1 Application Information ..... 15 8.2 Typical Applications ..... 15 <b>9 Power Supply Recommendations</b> ..... 18 <b>10 Layout</b> ..... 19 10.1 Layout Guidelines ..... 19 10.2 Layout Examples ..... 19 <b>11 Device and Documentation Support</b> ..... 20 11.1 Documentation Support ..... 20 11.2 Community Resources ..... 20 11.3 Trademarks ..... 20 11.4 Electrostatic Discharge Caution ..... 20 11.5 Glossary ..... 20 <b>12 Mechanical, Packaging, and Orderable Information</b> ..... 20
---	---

## 4 Revision History

NOTE: Page numbers for previous revisions may differ from page numbers in the current version.

### Changes from Revision H (April 2013) to Revision I

**Page**

- Added *Device Information* and *Pin Configuration and Functions* sections, *ESD Rating* and updated *Thermal Information* tables, *Feature Description*, *Device Functional Modes*, *Application and Implementation*, *Power Supply Recommendations*, *Layout*, *Device and Documentation Support*, and *Mechanical, Packaging, and Orderable Information* sections; remove lead temp from *Abs Max* table (in POA); remove obsolete heatsinking content; update thermal values ..... 1
- Deleted obsolete heatsinking information for DDPAK/TO-263 package ..... 18

### Changes from Revision G (April 2013) to Revision H

**Page**

- Changed layout of National data sheet to TI format ..... 1

## 5 Pin Configurations and Functions

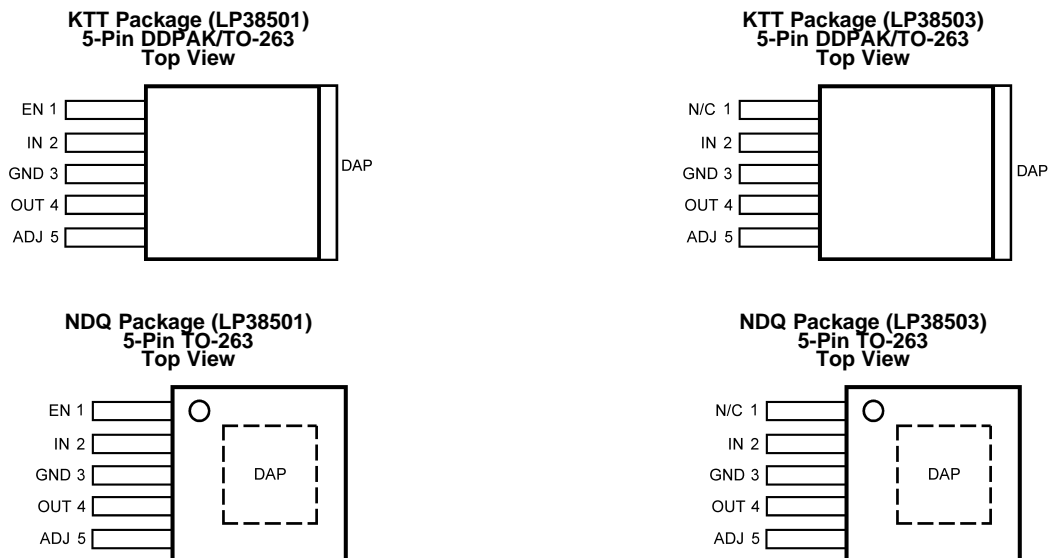

### Pin Functions

NAME	PIN				TYPE	DESCRIPTION
	LP38501	LP38503	LP38501	LP38503		
	DDPAK/TO-263		TO-263			
ADJ	5	5	5	5	O	Sets output voltage.
EN	1	—	1	—	I	Enable (LP38501-ADJ only). Pull high to enable the output, low to disable the output. This pin has no internal bias and must be either tied to the input voltage, or actively driven.
GND	3	3	3	3	G	Ground
IN	2	2	2	2	I	Input supply pin.
N/C	—	1	—	1	—	In the LP38503-ADJ, this pin has no internal connections. It can be left floating or used for trace routing.
OUT	4	4	4	4	O	Regulated output voltage pin.
DAP	√	√	√	√	—	The DAP is used as a thermal connection to remove heat from the device to the circuit board DAP copper clad area which acts as the heatsink. The DAP is electrically connected to the backside of the die. The DAP must be connected to ground potential, but can not be used as the only ground connection.

## 6 Specifications

### 6.1 Absolute Maximum Ratings

over operating free-air temperature range (unless otherwise noted)<sup>(1)</sup>

	MIN	MAX	UNIT
IN pin voltage (survival)	-0.3	6	V
EN pin voltage (survival)	-0.3	6	V
OUT pin voltage (survival)	-0.3	6	V
I <sub>OUT</sub> (survival)	Internally limited		
Power dissipation <sup>(2)</sup>	Internally limited		
Storage temperature, T <sub>stg</sub>	-65	150	°C

- (1) Stresses beyond those listed under *Absolute Maximum Ratings* may cause permanent damage to the device. These are stress ratings only, which do not imply functional operation of the device at these or any other conditions beyond those indicated under *Recommended Operating Conditions*. Exposure to absolute-maximum-rated conditions for extended periods may affect device reliability.
- (2) Operating junction temperature must be evaluated, and derated as needed, based on ambient temperature (T<sub>A</sub>), power dissipation (P<sub>D</sub>), maximum allowable operating junction temperature (T<sub>J(MAX)</sub>), and package thermal resistance (R<sub>θJA</sub>). See [Application and Implementation](#).

### 6.2 ESD Ratings

	VALUE	UNIT
V <sub>ESD</sub> Electrostatic discharge Human body model (HBM), per ANSI/ESDA/JEDEC JS-001, all pins <sup>(1)</sup>	±2000	V

- (1) JEDEC document JEP155 states that 500-V HBM allows safe manufacturing with a standard ESD control process.

### 6.3 Recommended Operating Conditions

over operating free-air temperature range (unless otherwise noted)<sup>(1)</sup>

	MIN	NOM	MAX	UNIT
Input supply voltage	2.7		5.5	V
Enable input voltage	0		5.5	V
Output current (DC)	0		3	A
V <sub>OUT</sub>	0.6		5	V
Junction temperature <sup>(2)</sup>	-40		125	°C

- (1) Stresses beyond those listed under *Absolute Maximum Ratings* may cause permanent damage to the device. These are stress ratings only, which do not imply functional operation of the device at these or any other conditions beyond those indicated under *Recommended Operating Conditions*. Exposure to absolute-maximum-rated conditions for extended periods may affect device reliability.
- (2) Operating junction temperature must be evaluated, and derated as needed, based on ambient temperature (T<sub>A</sub>), power dissipation (P<sub>D</sub>), maximum allowable operating junction temperature (T<sub>J(MAX)</sub>), and package thermal resistance (R<sub>θJA</sub>). See [Application and Implementation](#).

### 6.4 Thermal Information

THERMAL METRIC <sup>(1)</sup>	LP38501 and LP38503		UNIT
	KTT(DDPAK/TO-263)	NDQ (TO-263)	
	5 PINS	5 PINS	
R <sub>θJA</sub> Junction-to-ambient thermal resistance	41.8	33.3	°C/W
R <sub>θJC(top)</sub> Junction-to-case (top) thermal resistance	45.0	22.1	°C/W
R <sub>θJB</sub> Junction-to-board thermal resistance	24.8	16.9	°C/W
Ψ <sub>JT</sub> Junction-to-top characterization parameter	13.1	5.8	°C/W
Ψ <sub>JB</sub> Junction-to-board characterization parameter	23.8	16.8	°C/W
R <sub>θJC(bot)</sub> Junction-to-case (bottom) thermal resistance	2.4	2.3	°C/W

- (1) For more information about traditional and new thermal metrics, see the *Semiconductor and IC Package Thermal Metrics* application report, [SPRA953](#).

## 6.5 Electrical Characteristics

Unless otherwise specified  $V_{IN} = 3.3\text{ V}$ ,  $I_{OUT} = 10\text{ mA}$ ,  $C_{IN} = 10\text{ }\mu\text{F}$ ,  $C_{OUT} = 10\text{ }\mu\text{F}$ ,  $V_{EN} = V_{IN}$ ,  $V_{OUT} = 1.8\text{ V}$ . Minimum and maximum limits apply over the junction temperature ( $T_J$ ) range of  $-40^\circ\text{C}$  to  $+125^\circ\text{C}$  and are specified through test, design, or statistical correlation. Typical values represent the most likely parametric norm at  $T_J = 25^\circ\text{C}$ , and are provided for reference purposes only.

PARAMETER	TEST CONDITIONS	MIN	TYP	MAX	UNIT
$V_{ADJ}$ ADJ pin voltage <sup>(1)</sup>	$2.7\text{ V} \leq V_{IN} \leq 5.5\text{ V}$ $10\text{ mA} \leq I_{OUT} \leq 3\text{ A}$ $T_J = 25^\circ\text{C}$	0.584	0.605	0.626	V
	$2.7\text{ V} \leq V_{IN} \leq 5.5\text{ V}$ $10\text{ mA} \leq I_{OUT} \leq 3\text{ A}$	0.575		0.635	
$V_{ADJ}$ ADJ pin voltage (A grade) <sup>(1)</sup>	$2.7\text{ V} \leq V_{IN} \leq 5.5\text{ V}$ $10\text{ mA} \leq I_{OUT} \leq 3\text{ A}$ $T_J = 25^\circ\text{C}$	0.596	0.605	0.614	V
	$2.7\text{ V} \leq V_{IN} \leq 5.5\text{ V}$ $10\text{ mA} \leq I_{OUT} \leq 3\text{ A}$	0.587		0.623	
$I_{ADJ}$ ADJ pin bias current	$2.7\text{ V} \leq V_{IN} \leq 5.5\text{ V}$ $T_J = 25^\circ\text{C}$		50		nA
	$2.7\text{ V} \leq V_{IN} \leq 5.5\text{ V}$			750	nA
$V_{DO}$ Dropout voltage <sup>(2)</sup>	$I_{OUT} = 3\text{ A}$ $T_J = 25^\circ\text{C}$		420	550	mV
	$I_{OUT} = 3\text{ A}$			665	mV
$\frac{\Delta V_{OUT}}{\Delta V_{IN}}$ Output voltage line regulation <sup>(1)(3)</sup>	$2.7\text{ V} \leq V_{IN} \leq 5.5\text{ V}$ $T_J = 25^\circ\text{C}$		0.04		%V
	$2.7\text{ V} \leq V_{IN} \leq 5.5\text{ V}$		0.05		
$\frac{\Delta V_{OUT}}{\Delta I_{OUT}}$ Output voltage load regulation <sup>(1)(4)</sup>	$10\text{ mA} < I_{OUT} < 3\text{ A}$ $T_J = 25^\circ\text{C}$		0.12		%A
	$10\text{ mA} < I_{OUT} < 3\text{ A}$		0.24		
$I_{GND}$ Ground pin current in normal operation mode	$10\text{ mA} < I_{OUT} < 3\text{ A}$ $T_J = 25^\circ\text{C}$		2	4	mA
	$10\text{ mA} < I_{OUT} < 1.5\text{ A}$			5	
$I_{DISABLED}$ Ground pin current	$V_{EN} < V_{IL(EN)}$ , $T_J = 25^\circ\text{C}$		0.025	0.125	$\mu\text{A}$
	$V_{EN} < V_{IL(EN)}$			15	
$I_{OUT(PK)GND}$ Peak output current	$V_{OUT} \geq V_{OUT(NOM)} - 5\%$		6		A
$I_{SC}$ Short-circuit current	$V_{OUT} = 0\text{ V}$		6		A
	$V_{OUT} = 0\text{ V}$ , $T_J = 25^\circ\text{C}$	3.5			
<b>ENABLE INPUT (LP38501 Only)</b>					
$V_{IH(EN)}$ Enable logic high	$V_{OUT} = \text{ON}$	1.4			V
$V_{IL(EN)}$ Enable logic low	$V_{OUT} = \text{OFF}$			0.65	
$t_{d(off)}$ Turnoff delay	Time from $V_{EN} < V_{IL(EN)}$ to $V_{OUT} = \text{OFF}$ $I_{LOAD} = 3\text{ A}$		25		$\mu\text{s}$
$t_{d(on)}$ Turnon delay	Time from $V_{EN} > V_{IH(EN)}$ to $V_{OUT} = \text{ON}$ $I_{LOAD} = 3\text{ A}$		25		$\mu\text{s}$
$I_{IH(EN)}$ Enable pin high current	$V_{EN} = V_{IN}$		35		nA
$I_{IL(EN)}$ Enable pin low current	$V_{EN} = 0\text{ V}$		35		

- (1) The line and load regulation specification contains only the typical number. However, the limits for line and load regulation are included in the adjust voltage tolerance specification.
- (2) Dropout voltage is defined as the minimum input to output differential voltage at which the output drops 2% below the nominal value. For any output voltage less than 2.5 V, the minimum  $V_{IN}$  operating voltage is the limiting factor.
- (3) Output voltage line regulation is defined as the change in output voltage from the nominal value due to change in the input line voltage.
- (4) Output voltage load regulation is defined as the change in output voltage from the nominal value due to change in the load current.

## Electrical Characteristics (continued)

Unless otherwise specified  $V_{IN} = 3.3\text{ V}$ ,  $I_{OUT} = 10\text{ mA}$ ,  $C_{IN} = 10\text{ }\mu\text{F}$ ,  $C_{OUT} = 10\text{ }\mu\text{F}$ ,  $V_{EN} = V_{IN}$ ,  $V_{OUT} = 1.8\text{ V}$ . Minimum and maximum limits apply over the junction temperature ( $T_J$ ) range of  $-40^\circ\text{C}$  to  $+125^\circ\text{C}$  and are specified through test, design, or statistical correlation. Typical values represent the most likely parametric norm at  $T_J = 25^\circ\text{C}$ , and are provided for reference purposes only.

PARAMETER		TEST CONDITIONS	MIN	TYP	MAX	UNIT
<b>AC PARAMETERS</b>						
PSRR	Ripple rejection	$V_{IN} = 3\text{ V}$ , $I_{OUT} = 3\text{ A}$ , $f = 120\text{ Hz}$		58		dB
		$V_{IN} = 3\text{ V}$ , $I_{OUT} = 3\text{ A}$ , $f = 1\text{ kHz}$		56		
$\rho_{n(f)}$	Output noise density	$f = 120\text{ Hz}$ , $C_{OUT} = 10\text{ }\mu\text{F CER}$		1		$\mu\text{V}/\sqrt{\text{Hz}}$
$e_n$	Output noise voltage	$\text{BW} = 100\text{ Hz} - 100\text{ kHz}$ $C_{OUT} = 10\text{ }\mu\text{F CER}$		100		$\mu\text{V}_{(\text{RMS})}$
<b>THERMALS</b>						
$T_{SD}$	Thermal shutdown	$T_J$ rising		170	—	$^\circ\text{C}$
$\Delta T_{SD}$	Thermal shutdown hysteresis	$T_J$ falling from $T_{SD}$		10	—	$^\circ\text{C}$

### 6.6 Typical Characteristics

Unless otherwise specified:  $T_J = 25^\circ\text{C}$ ,  $V_{IN} = 2.7\text{ V}$ ,  $V_{EN} = V_{IN}$ ,  $C_{IN} = 10\ \mu\text{F}$ ,  $C_{OUT} = 10\ \mu\text{F}$ ,  $I_{OUT} = 10\ \text{mA}$ ,  $V_{OUT} = 1.8\ \text{V}$ .

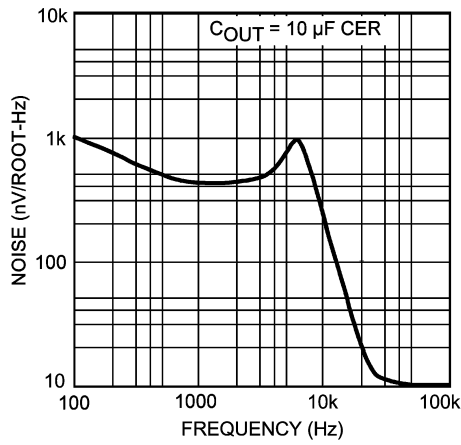

Figure 1. Noise Density

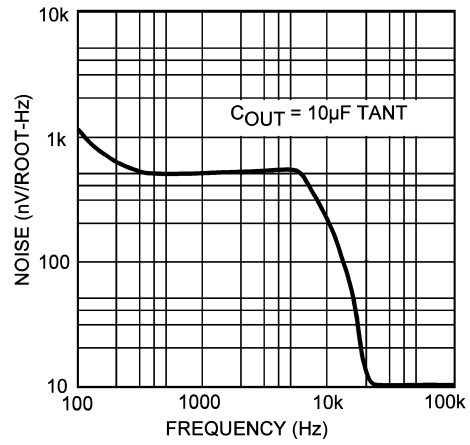

Figure 2. Noise Density

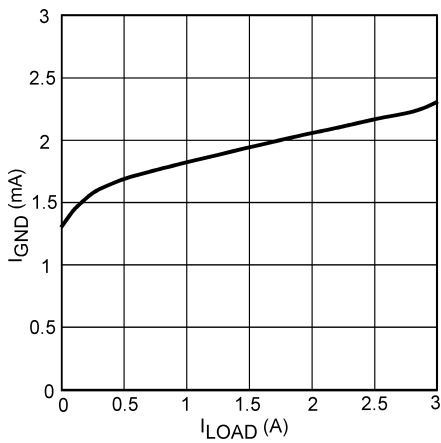

Figure 3.  $I_{GND}$  vs Load Current

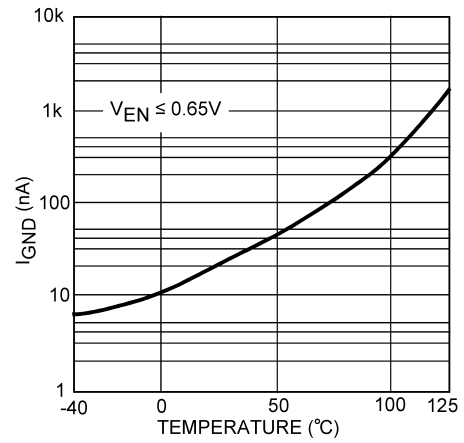

Figure 4.  $I_{GND(OFF)}$  vs Temperature

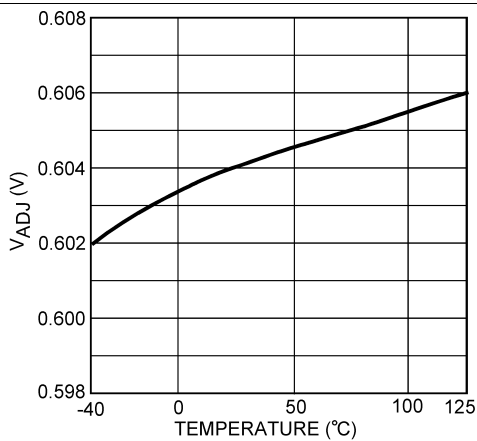

Figure 5.  $V_{ADJ}$  vs Temperature

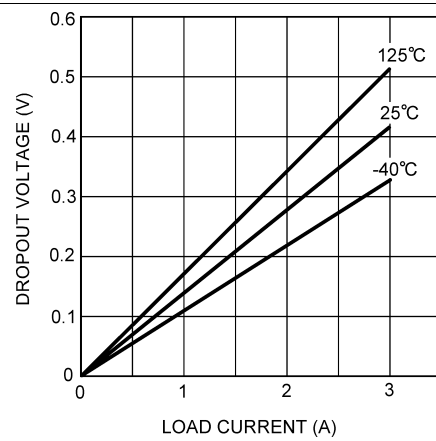

Figure 6. Dropout Voltage vs Load Current

### Typical Characteristics (continued)

Unless otherwise specified:  $T_J = 25^\circ\text{C}$ ,  $V_{IN} = 2.7\text{ V}$ ,  $V_{EN} = V_{IN}$ ,  $C_{IN} = 10\ \mu\text{F}$ ,  $C_{OUT} = 10\ \mu\text{F}$ ,  $I_{OUT} = 10\ \text{mA}$ ,  $V_{OUT} = 1.8\ \text{V}$ .

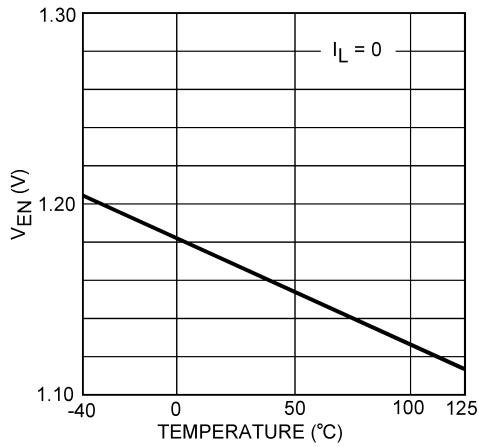

Figure 7.  $V_{EN}$  vs Temperature

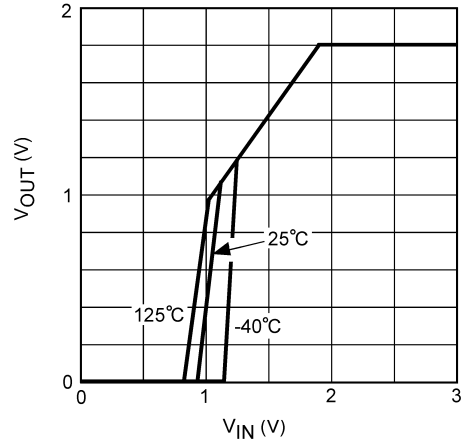

Figure 8. Turnon Characteristics

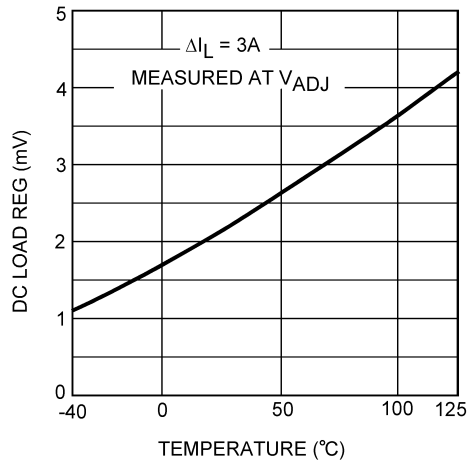

Figure 9. Load Regulation vs Temperature

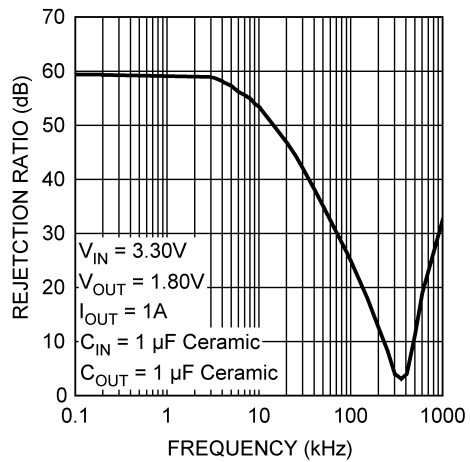

Figure 10. PSRR



## 7 Detailed Description

### 7.1 Overview

The LP38501-ADJ and LP38503-ADJ are FlexCap and low-dropout adjustable regulators, the output voltage can be set from 0.6 V to 5 V. Standard regulator features, such as overcurrent and overtemperature protections, are also included.

The LP38501-ADJ and LP38503-ADJ contain several features:

- Stable with any type of output capacitor
- Fast load transient response
- Disable Mode (LP38501-ADJ only)

### 7.2 Functional Block Diagrams

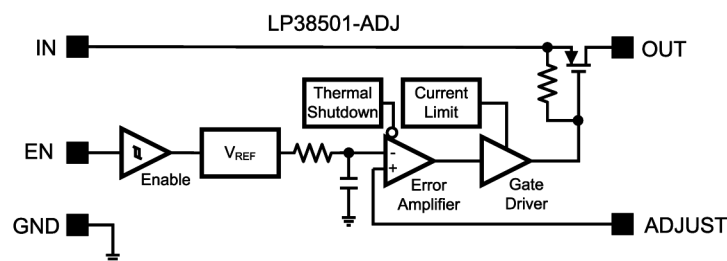

Figure 11. LP38501-ADJ Block Diagram

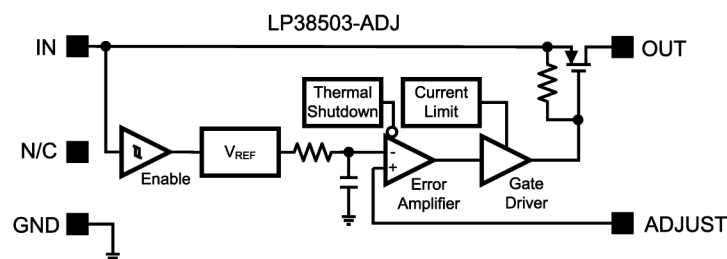

Figure 12. LP38503-ADJ Block Diagram

### 7.3 Feature Description

#### 7.3.1 Stability and Phase Margin

Any regulator which operates using a feedback loop must be compensated in such a way as to ensure adequate phase margin, which is defined as the difference between the phase shift and  $-180$  degrees at the frequency where the loop gain crosses unity (0 dB). For most LDO regulators, the ESR of the output capacitor is required to create a zero to add enough phase lead to ensure stable operation.

Figure 13 shows the gain/phase plot of the LP38501-ADJ and LP38503-ADJ with an output of 1.2 V, a 10- $\mu$ F ceramic output capacitor, delivering 2 A of load current. The unity-gain crossover occurs at 300 kHz, and the phase margin is about  $40^\circ$  (which is very stable).

**Feature Description (continued)**

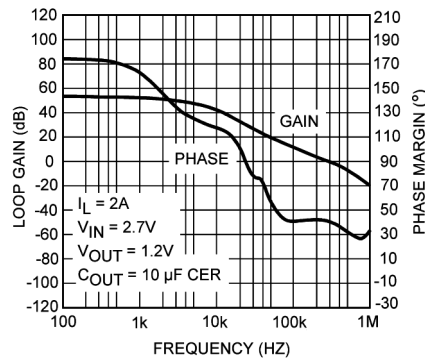

**Figure 13. Gain-Bandwidth Plot for 2-A Load**

Figure 14 shows the gain and phase with no external load. In this case, the only load is provided by the gain setting resistors (about 12 kΩ total in this test). It is immediately obvious that the unity-gain frequency is significantly lower (dropping to about 500 Hz), at which point the phase margin is 125°.

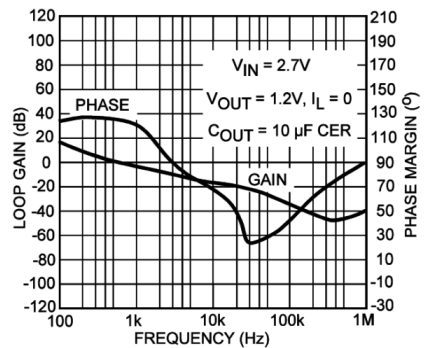

**Figure 14. Gain-Bandwidth Plot for No Load**

The reduction in unity-gain bandwidth as load current is reduced is normal for any LDO regulator using a P-FET or PNP pass transistor, because they have a pole in the loop gain function given by:

$$F_P = \frac{1}{2 \times \pi \times R_L \times C_{OUT}} \tag{1}$$

Equation 1 calculates how the pole goes to the highest frequency when  $R_L$  is minimum value (maximum load current). In general, LDOs have maximum bandwidth (and lowest phase margin) at full load current. In the case of the LP38501-ADJ, good phase margin is seen even when using ceramic capacitors with ESR values of only a few mΩ.

**7.3.2 Load Transient Response**

Load transient response is defined as the change in regulated output voltage which occurs as a result of a change in load current. Many applications have loads which vary, and the control loop of the voltage regulator must adjust the current in the pass FET transistor in response to load current changes. For this reason, regulators with wider bandwidths often have better transient response.

The LP38501-ADJ employs an internal feed-forward design which makes the load transient response much faster than would be predicted simply by loop speed; this feedforward means any voltage changes appearing on the output are coupled through to the high-speed driver used to control the gate of the pass FET along a signal path using very fast FET devices. Because of this, the pass transistor’s current can change very quickly.

Feature Description (continued)

Figure 15 shows the output transient response resulting from a change in load current of 0.1 A – 3 A, and then 3 A – 0.1 A with a load current slew rate of 500 mA/μs. As shown in Figure 15, the resulting change in output voltage is only about 40 mV (peak), which is just slightly over 2% for the 1.8-V output used for this test. This is excellent performance for such a small output capacitor.

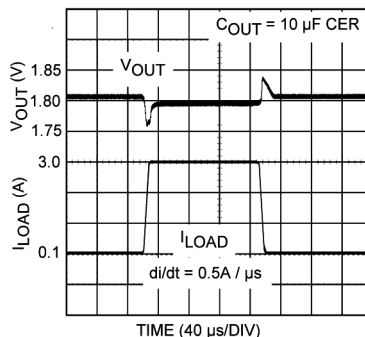

Figure 15. Load Transient Response: 10-μF Ceramic, 0.5-A/μs Di/Dt

When the load current changes much more quickly, the output voltage will show more change because the loop and internal feedforward circuitry are not able to react as fast as the load changes. In such cases, it is the output capacitor which must supply load current during the transition until the loop responds and changes the pass transistor’s drive to deliver the new value of load current. As an example, the slew rate of the load current will be increased to 75 A/μs and the same test will be performed. In Figure 16, it can be seen that the peak excursion of the output voltage during the transient has now increased to about 200 mV, which is just slightly over 11% for the 1.8-V output.

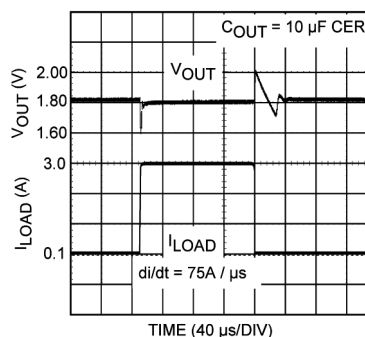

Figure 16. Load Transient Response: 10-μF Ceramic, 75 A/μs di/dt

A better understanding of the load transient can be obtained when the load’s rising edge is expanded in time scale (Figure 17).

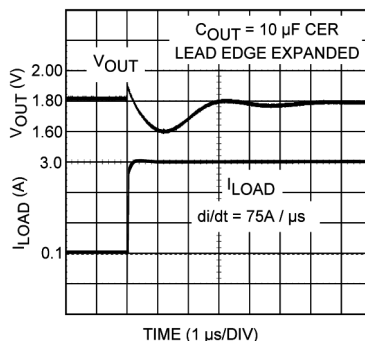

Figure 17. Rising Edge, 10-μF Ceramic, 75 A/μs di/dt

## Feature Description (continued)

Figure 16 shows that the output voltage starts “correcting” back upwards after less than a microsecond, and has fully reversed direction after about 1.2  $\mu\text{s}$ . This very rapid reaction is a result of the maximum loop bandwidth (full load is being delivered) and the feedforward effect kicking on the drive to the FET before feedback gets fully around the loop.

In cases where extremely fast load changes occur, and output voltage regulation better than 10% is required, the output capacitance must be increased. When selecting capacitors, it must be understood that the better performing ones usually cost the most. For fast changing loads, the internal parasitics of ESR (equivalent series resistance) and ESL (equivalent series inductance) degrade the capacitor’s ability to source current quickly to the load. The best capacitor types for transient performance are (in order):

1. Multilayer Ceramic: with the lowest values of ESR and ESL, they can have ESR values in the range of a few milli Ohms. Disadvantage: capacitance values above about 22  $\mu\text{F}$  significantly increase in cost.
2. Low-ESR Aluminum Electrolytics: these are aluminum types (like OSCON) with a special electrolyte which provides extremely low ESR values, and are the closest to ceramic performance while still providing large amounts of capacitance. These are cheaper (by capacitance) than ceramic.
3. Solid tantalum: can provide several hundred  $\mu\text{F}$  of capacitance, transient performance is slightly worse than OSCON type capacitors, cheaper than ceramic in large values.
4. General purpose aluminum electrolytics: cheap and provide a lot of capacitance, but give the worst performance.

As a first example, larger values of ceramic capacitance show how much reduction can be obtained from the 200-mV output change (Figure 16) which was seen with only a 10- $\mu\text{F}$  ceramic output capacitor. In Figure 18, the 10- $\mu\text{F}$  output capacitor is increased to 22  $\mu\text{F}$ . The 200-mV transient is reduced to about 160 mV, which is from about 11% of  $V_{\text{OUT}}$  down to about 9%.

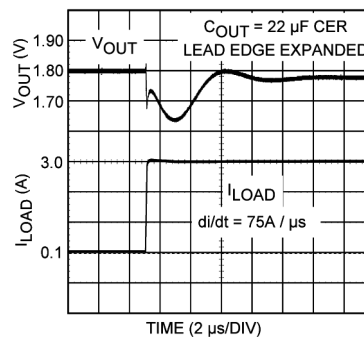

**Figure 18. 22- $\mu\text{F}$  Ceramic Output Capacitor**

In Figure 19, the output capacitance is increased to 47  $\mu\text{F}$  ceramic. It can be seen that the output transient is further reduced down to about 120 mV, which is still about 6.6% of the output voltage. This shows that a 5X increase in ceramic capacitance from the original 10  $\mu\text{F}$  only reduced the peak voltage transient amplitude by about 40%.

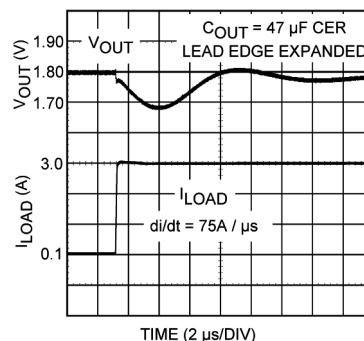

**Figure 19. 47- $\mu\text{F}$  Ceramic Output Capacitor**

## Feature Description (continued)

In general, managing load transients is done by paralleling ceramic capacitance with a larger bulk capacitance. In this way, the ceramic can source current during the rapidly changing edge and the bulk capacitor can support the load current after the first initial spike in current.

In the next test, the same 10- $\mu\text{F}$  ceramic capacitor is paralleled with a general-purpose (less expensive) aluminum electrolytic whose capacitance is 220  $\mu\text{F}$ . As shown in Figure 20, there is a small improvement over the 200 mV peak seen with the 10- $\mu\text{F}$  ceramic capacitor alone. By adding the 220  $\mu\text{F}$  aluminum capacitor, the peak is reduced to about 160 mV (the same peak value as seen with a 22- $\mu\text{F}$  ceramic capacitor alone).

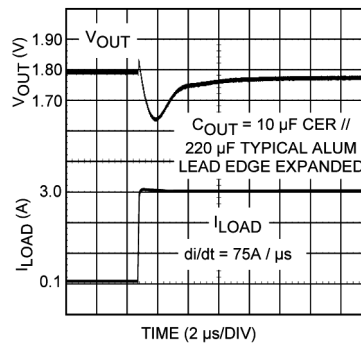

Figure 20. 10- $\mu\text{F}$  Ceramic Paralleled by 220- $\mu\text{F}$  Generic Aluminum Electrolytic

A solid Tantalum works better, so the aluminum electrolytic is replaced by a 220- $\mu\text{F}$  Tantalum (Figure 21). The peak amplitude of the output transient is now reduced to about 130 mV, just slightly less efficient than the value of the 47- $\mu\text{F}$  ceramic capacitor alone.

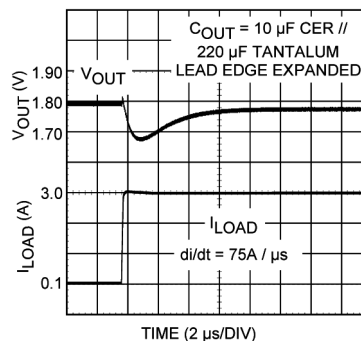
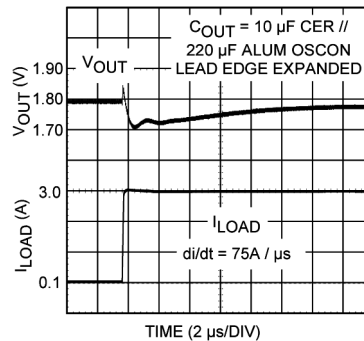

Figure 21. 10- $\mu\text{F}$  Ceramic Paralleled by 220- $\mu\text{F}$  Tantalum

The OSCON (ultra low ESR) aluminum electrolytic is the best of the electrolytics. Figure 22 shows the output voltage transient is reduced down to about 90 mV (about 5% of  $V_{OUT}$ ) when a 220- $\mu\text{F}$  OSCON is added to the 10  $\mu\text{F}$  ceramic. This indicates that some kind of ultra-low ESR aluminum electrolytic used in parallel with some ceramic capacitance is probably the best approach for extremely fast transients, but each application must be dialed in for its specific load requirements.

## Feature Description (continued)



**Figure 22. 10- $\mu\text{F}$  Ceramic Paralleled by 220- $\mu\text{F}$  OSCON**

### 7.3.3 Dropout Voltage

The dropout voltage of a regulator is defined as the input-to-output differential required by the regulator to keep the output voltage within 2% of the nominal value. For CMOS LDOs, the dropout voltage is the product of the load current and the  $R_{DS(on)}$  of the internal MOSFET pass element.

Because the output voltage is beginning to “drop out” of regulation when it drops by 2%, electrical performance of the device is reduced compared to the values listed in [Electrical Characteristics](#) for some parameters (line and load regulation and PSRR would be affected).

### 7.3.4 Reverse Current Path

The internal MOSFET pass element in the LP38501-ADJ and LP38503-ADJ has an inherent parasitic diode. During normal operation, the input voltage is higher than the output voltage and the parasitic diode is reverse biased. However, if the output is pulled above the input in an application, then current flows from the output to the input as the parasitic diode gets forward biased. The output can be pulled above the input as long as the current in the parasitic diode is limited to 200-mA continuous and 1-A peak. The regulator output pin must not be taken below ground potential. If the LP38501-ADJ and LP38503-ADJ is used in a dual-supply system where the regulator load is returned to a negative supply, the output must be diode-clamped to ground.

### 7.3.5 Short-Circuit Protection

The LP38501-ADJ and LP38503-ADJ contain internal current limiting which reduces output current to a safe value if the output is overloaded or shorted. Depending upon the value of  $V_{IN}$ , thermal limiting may also become active as the average power dissipated causes the die temperature to increase to the limit value (about 170°C). The hysteresis of the thermal shutdown circuitry can result in a “cyclic” behavior on the output as the die temperature heats and cools.

## 7.4 Device Functional Modes

### 7.4.1 Enable Operation (LP38501-ADJ Only)

The ENABLE pin (EN) must be actively terminated by either a 10-k $\Omega$  pullup resistor to  $V_{IN}$ , or a driver which actively pulls high and low (such as a CMOS rail to rail comparator). If active drive is used, the pullup resistor is not required. This pin must be tied to  $V_{IN}$  if not used (it must not be left floating).

## 8 Application and Implementation

### NOTE

Information in the following applications sections is not part of the TI component specification, and TI does not warrant its accuracy or completeness. TI's customers are responsible for determining suitability of components for their purposes. Customers should validate and test their design implementation to confirm system functionality.

### 8.1 Application Information

The LP38501-ADJ and LP38503-ADJ devices can provide 3-A output current with 2.7-V to 5.5-V input voltage. These ultra-low-dropout linear regulators respond very quickly to step changes in load, making them suitable for low-voltage microprocessor applications. Input and output capacitors of at least 10  $\mu\text{F}$  are required.

### 8.2 Typical Applications

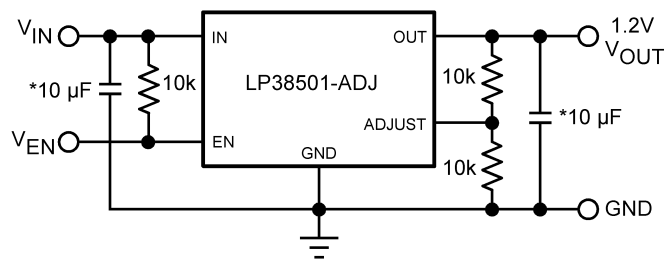

\*Minimum capacitance required (see [Detailed Design Procedure](#)).

Figure 23. Typical Circuit (LP38501)

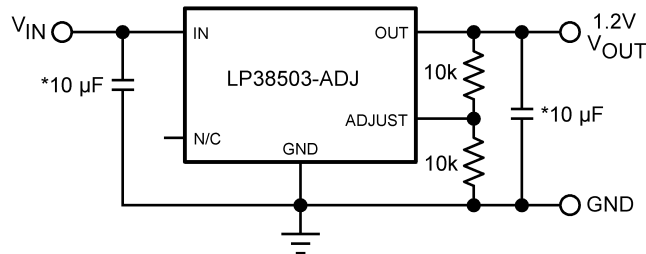

\*Minimum capacitance required (see [Detailed Design Procedure](#)).

Figure 24. Typical Circuit (LP38503)

#### 8.2.1 Design Requirements

For LP3850x-ADJ typical applications, use the parameters listed in [Table 1](#) as the input parameters.

Table 1. Design Parameters

DESIGN PARAMETERS	VALUE
Input voltage	2.7 V to 5.5 V
Output voltage	0.6 V to 5 V (adjustable)
Output current	3 A (maximum)
Input capacitor	10 $\mu\text{F}$ (minimum)
Output capacitor	10 $\mu\text{F}$ (minimum)

## 8.2.2 Detailed Design Procedure

### 8.2.2.1 External Capacitors

The LP38501-ADJ and LP38503-ADJ require that at least 10- $\mu$ F ( $\pm 20\%$ ) capacitors be used at the input and output pins located within one cm of the device. Larger capacitors may be used without limit on size for both  $C_{IN}$  and  $C_{OUT}$ . Capacitor tolerances such as temperature variation and voltage loading effects must be considered when selecting capacitors to ensure that they provide the minimum required amount of capacitance under all operating conditions for the application.

In general, ceramic capacitors are best for noise bypassing and transient response because of their ultra low ESR. It must be noted that if ceramics are used, only the types with X5R or X7R dielectric ratings must be used (never Z5U or Y5F). Capacitors which have the Z5U or Y5F characteristics have a drop in capacitance of as much as 50% if their temperature increases from 25°C to 85°C. In addition, the capacitance drops significantly with applied voltage: a typical Z5U or Y5F capacitor can lose as much as 60% of its rated capacitance if only half of the rated voltage is applied to it. For these reasons, only X5R and X7R ceramics must be used.

### 8.2.2.2 Input Capacitor

All linear regulators can be affected by the source impedance of the voltage which is connected to the input. If the source impedance is too high, the reactive component of the source may affect the control loop's phase margin. *To ensure proper loop operation, the ESR of the capacitor used for  $C_{IN}$  must not exceed 0.5  $\Omega$ .* Any good quality ceramic capacitor meets this requirement, as well as many good quality tantalums. Aluminum electrolytic capacitors may also work, but can possibly have an ESR which increases significantly at cold temperatures. If the ESR of the input capacitor may exceed 0.5  $\Omega$ , it is recommended that a 2.2- $\mu$ F ceramic capacitor be used in parallel, as this assures stable loop operation.

### 8.2.2.3 Output Capacitor

Any type of capacitor may be used for  $C_{OUT}$ , with no limitations on minimum or maximum ESR, as long as the minimum amount of capacitance is present. The amount of capacitance can be increased without limit. Increasing the size of  $C_{OUT}$  typically gives improved load transient response.

### 8.2.2.4 Setting The Output Voltage

The output voltage of the LP38501-ADJ and LP38503-ADJ can be set to any value between 0.6 V and 5 V using two external resistors shown as R1 and R2 in [Figure 25](#).

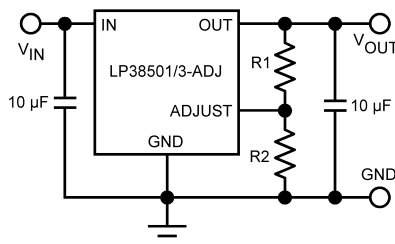

Figure 25. Setting Output Voltage

The value of R2 must always be less than or equal to 10 k $\Omega$  for good loop compensation. R1 can be selected for a given  $V_{OUT}$  using the following formula:

$$V_{OUT} = V_{ADJ} (1 + R1/R2) + I_{ADJ} (R1)$$

where

- $V_{ADJ}$  is the adjust pin voltage
- $I_{ADJ}$  is the bias current flowing into the adjust pin

(2)



### 8.2.2.5 RFI/EMI Susceptibility

Radio frequency interference (RFI) and electro-magnetic interference (EMI) can degrade any integrated circuit's performance because of the small dimensions of the geometries inside the device. In applications where circuit sources are present which generate signals with significant high frequency energy content (> 1 MHz), care must be taken to ensure that this does not affect the device regulator.

If RFI/EMI noise is present on the input side of the regulator (such as applications where the input source comes from the output of a switching regulator), good ceramic bypass capacitors must be used at the input pin of the device to reduce the amount of EMI conducted into the device.

If the LP38501-ADJ or LP38503-ADJ output is connected to a load which switches at high speed (such as a clock), the high-frequency current pulses required by the load must be supplied by the capacitors on the device output. Because the bandwidth of the regulator loop is less than 300 kHz, the control circuitry cannot respond to load changes above that frequency. This means the effective output impedance of the device at frequencies above 300 kHz is determined only by the output capacitor(s). Ceramic capacitors provide the best performance in this type of application.

In applications where the load is switching at high speed, the output of the device may need RF isolation from the load. In such cases, it is recommended that some inductance be placed between the output capacitor and the load, and good RF bypass capacitors be placed directly across the load. PCB layout is also critical in high noise environments, because RFI/EMI is easily radiated directly into PC traces. Noisy circuitry must be isolated from *clean* circuits where possible, and grounded through a separate path. At MHz frequencies, ground planes begin to look inductive and RFI/EMI can cause ground bounce across the ground plane. In multi-layer PC Board applications, care must be taken in layout so that noisy power and ground planes do not radiate directly into adjacent layers which carry analog power and ground.

### 8.2.2.6 Output Noise

Noise is specified in two ways:

- Spot noise or output noise density is the RMS sum of all noise sources, measured at the regulator output, at a specific frequency (measured with a 1-Hz bandwidth). This type of noise is usually plotted on a curve as a function of frequency.
- Total output noise or broadband noise is the RMS sum of spot noise over a specified bandwidth, usually several decades of frequencies.

Spot noise is measured in units  $\mu\text{V}/\sqrt{\text{Hz}}$  or  $\text{nV}/\sqrt{\text{Hz}}$  and total output noise is measured in  $\mu\text{V}_{(\text{RMS})}$ . The primary source of noise in low-dropout regulators is the internal reference. In CMOS regulators, noise has a low-frequency component and a high frequency component, which depend strongly on the silicon area and quiescent current.

Noise can generally be reduced in two ways: by increasing the transistor area or increasing the reference current. However, enlarging the transistors increases die size, and increasing the reference current means higher total supply current (GND pin current).

### 8.2.2.7 Power Dissipation/Heatsinking

The maximum power dissipation ( $P_{\text{D}(\text{MAX})}$ ) of the LP38501-ADJ and LP38503-ADJ is limited by the maximum junction temperature of 125°C, along with the maximum ambient temperature ( $T_{\text{A}(\text{MAX})}$ ) of the application, and the thermal resistance ( $R_{\theta\text{JA}}$ ) of the package. Under all possible conditions, the junction temperature ( $T_{\text{J}}$ ) must be within the range specified in the [Recommended Operating Conditions](#). The total power dissipation of the device is given by:

$$P_{\text{D}} = ((V_{\text{IN}} - V_{\text{OUT}}) \times I_{\text{OUT}}) + (V_{\text{IN}} \times I_{\text{GND}})$$

where

- $I_{\text{GND}}$  is the operating ground current of the device (specified under [Electrical Characteristics](#)). (3)

The maximum allowable junction temperature rise ( $\Delta T_{\text{J}}$ ) depends on the maximum expected ambient temperature ( $T_{\text{A}(\text{MAX})}$ ) of the application, and the maximum allowable junction temperature ( $T_{\text{J}(\text{MAX})}$ ):

$$\Delta T_{\text{J}} = T_{\text{J}(\text{MAX})} - T_{\text{A}(\text{MAX})} \quad (4)$$

The maximum allowable value for junction-to-ambient thermal resistance,  $R_{\theta\text{JA}}$ , can be calculated using the formula:

$$R_{\theta\text{JA}} = \Delta T_{\text{J}} / P_{\text{D}(\text{MAX})} \quad (5)$$

The LP38501-ADJ and LP38503-ADJ are available in the DDPAK/TO-263 and TO-263 packages. The thermal resistance depends on the amount of copper area allocated to heat transfer.

### 8.2.3 Application Curves

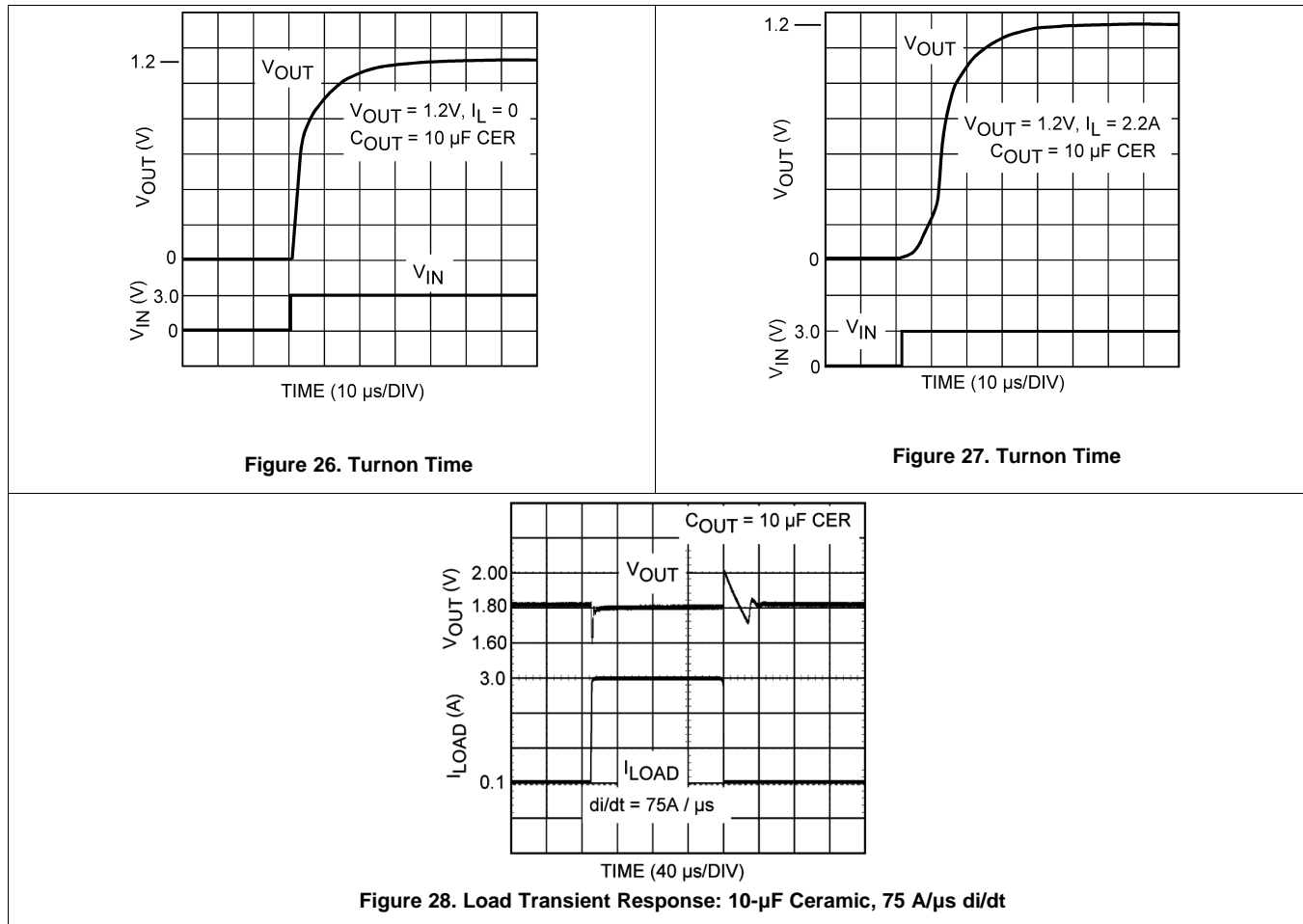

## 9 Power Supply Recommendations

The LP38501-ADJ and LP38503-ADJ devices are designed to operate from an input voltage supply range between 2.7 V and 5.5 V. The input voltage range provides adequate headroom in order for the device to have a regulated output. This input supply must be well regulated. An input capacitor of at least 10  $\mu F$  is required.

## 10 Layout

### 10.1 Layout Guidelines

Good layout practices minimize voltage error and prevent instability which can result from ground loops. The input and output capacitors must be directly connected to the device pins with short traces that have no other current flowing in them (Kelvin connect).

The best way to do this is to place the capacitors very near the device and make connections directly to the device pins via short traces on the top layer of the PCB. The regulator ground pin must be connected through vias to the internal or backside ground plane so that the regulator has a single point ground.

The external resistors which set the output voltage must also be located very near the device with all connections directly tied via short traces to the pins of the device (Kelvin connect). Do not connect the resistive divider to the load point or DC error could be induced.

### 10.2 Layout Examples

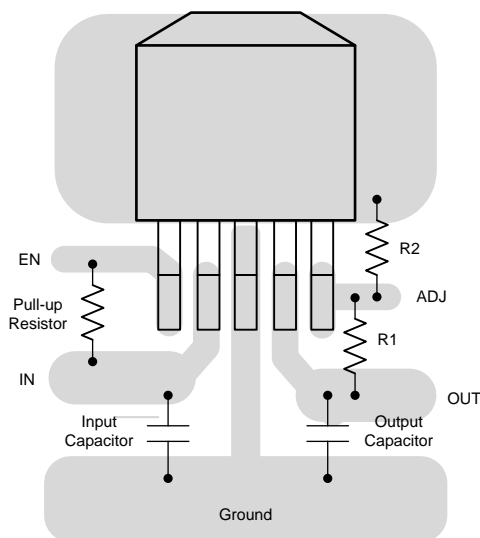

**Figure 29. LP38501-ADJ TO-263 Layout**

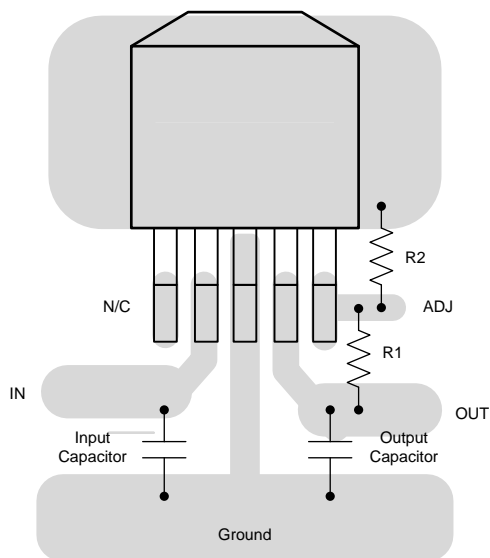

**Figure 30. LP38503-ADJ TO-263 Layout**

## 11 Device and Documentation Support

### 11.1 Documentation Support

#### 11.1.1 Related Links

[Table 2](#) lists quick access links. Categories include technical documents, support and community resources, tools and software, and quick access to sample or buy.

**Table 2. Related Links**

PARTS	PRODUCT FOLDER	SAMPLE & BUY	TECHNICAL DOCUMENTS	TOOLS & SOFTWARE	SUPPORT & COMMUNITY
LP38501-ADJ	<a href="#">Click here</a>	<a href="#">Click here</a>	<a href="#">Click here</a>	<a href="#">Click here</a>	<a href="#">Click here</a>
LP38503-ADJ	<a href="#">Click here</a>	<a href="#">Click here</a>	<a href="#">Click here</a>	<a href="#">Click here</a>	<a href="#">Click here</a>

### 11.2 Community Resources

The following links connect to TI community resources. Linked contents are provided "AS IS" by the respective contributors. They do not constitute TI specifications and do not necessarily reflect TI's views; see TI's [Terms of Use](#).

**TI E2E™ Online Community** *TI's Engineer-to-Engineer (E2E) Community*. Created to foster collaboration among engineers. At [e2e.ti.com](http://e2e.ti.com), you can ask questions, share knowledge, explore ideas and help solve problems with fellow engineers.

**Design Support** *TI's Design Support* Quickly find helpful E2E forums along with design support tools and contact information for technical support.

### 11.3 Trademarks

E2E is a trademark of Texas Instruments.  
All other trademarks are the property of their respective owners.

### 11.4 Electrostatic Discharge Caution



These devices have limited built-in ESD protection. The leads should be shorted together or the device placed in conductive foam during storage or handling to prevent electrostatic damage to the MOS gates.

### 11.5 Glossary

[SLYZ022](#) — *TI Glossary*.

This glossary lists and explains terms, acronyms, and definitions.

## 12 Mechanical, Packaging, and Orderable Information

The following pages include mechanical, packaging, and orderable information. This information is the most current data available for the designated devices. This data is subject to change without notice and revision of this document. For browser-based versions of this data sheet, refer to the left-hand navigation.

**PACKAGING INFORMATION**

Orderable Device	Status (1)	Package Type	Package Drawing	Pins	Package Qty	Eco Plan (2)	Lead/Ball Finish (6)	MSL Peak Temp (3)	Op Temp (°C)	Device Marking (4/5)	Samples
LP38501ATJ-ADJ/NOPB	ACTIVE	TO-263	NDQ	5	1000	Green (RoHS & no Sb/Br)	SN	Level-1-260C-UNLIM	-40 to 125	LP38501A TJ-ADJ	<a href="#">Samples</a>
LP38501TJ-ADJ/NOPB	ACTIVE	TO-263	NDQ	5	1000	Green (RoHS & no Sb/Br)	SN	Level-1-260C-UNLIM		LP38501 TJ-ADJ	<a href="#">Samples</a>
LP38501TS-ADJ/NOPB	ACTIVE	DDPAK/ TO-263	KTT	5	45	Green (RoHS & no Sb/Br)	SN	Level-3-245C-168 HR	-40 to 125	LP38501 TS-ADJ	<a href="#">Samples</a>
LP38501TSX-ADJ/NOPB	ACTIVE	DDPAK/ TO-263	KTT	5	500	Green (RoHS & no Sb/Br)	SN	Level-3-245C-168 HR	-40 to 125	LP38501 TS-ADJ	<a href="#">Samples</a>
LP38503ATJ-ADJ/NOPB	ACTIVE	TO-263	NDQ	5	1000	Green (RoHS & no Sb/Br)	SN	Level-1-260C-UNLIM	-40 to 125	LP38503A TJ-ADJ	<a href="#">Samples</a>
LP38503TJ-ADJ/NOPB	ACTIVE	TO-263	NDQ	5	1000	Green (RoHS & no Sb/Br)	SN	Level-1-260C-UNLIM	-40 to 125	LP38503 TJ-ADJ	<a href="#">Samples</a>
LP38503TS-ADJ/NOPB	ACTIVE	DDPAK/ TO-263	KTT	5	45	Green (RoHS & no Sb/Br)	SN	Level-3-245C-168 HR	-40 to 125	LP38503 TS-ADJ	<a href="#">Samples</a>
LP38503TSX-ADJ/NOPB	ACTIVE	DDPAK/ TO-263	KTT	5	500	Green (RoHS & no Sb/Br)	SN	Level-3-245C-168 HR	-40 to 125	LP38503 TS-ADJ	<a href="#">Samples</a>

(1) The marketing status values are defined as follows:

**ACTIVE:** Product device recommended for new designs.

**LIFEBUY:** TI has announced that the device will be discontinued, and a lifetime-buy period is in effect.

**NRND:** Not recommended for new designs. Device is in production to support existing customers, but TI does not recommend using this part in a new design.

**PREVIEW:** Device has been announced but is not in production. Samples may or may not be available.

**OBSELETE:** TI has discontinued the production of the device.

(2) **RoHS:** TI defines "RoHS" to mean semiconductor products that are compliant with the current EU RoHS requirements for all 10 RoHS substances, including the requirement that RoHS substance do not exceed 0.1% by weight in homogeneous materials. Where designed to be soldered at high temperatures, "RoHS" products are suitable for use in specified lead-free processes. TI may reference these types of products as "Pb-Free".

**RoHS Exempt:** TI defines "RoHS Exempt" to mean products that contain lead but are compliant with EU RoHS pursuant to a specific EU RoHS exemption.

**Green:** TI defines "Green" to mean the content of Chlorine (Cl) and Bromine (Br) based flame retardants meet JS709B low halogen requirements of <=100ppm threshold. Antimony trioxide based flame retardants must also meet the <=1000ppm threshold requirement.

(3) MSL, Peak Temp. - The Moisture Sensitivity Level rating according to the JEDEC industry standard classifications, and peak solder temperature.

(4) There may be additional marking, which relates to the logo, the lot trace code information, or the environmental category on the device.

<sup>(5)</sup> Multiple Device Markings will be inside parentheses. Only one Device Marking contained in parentheses and separated by a "-" will appear on a device. If a line is indented then it is a continuation of the previous line and the two combined represent the entire Device Marking for that device.

<sup>(6)</sup> Lead/Ball Finish - Orderable Devices may have multiple material finish options. Finish options are separated by a vertical ruled line. Lead/Ball Finish values may wrap to two lines if the finish value exceeds the maximum column width.

**Important Information and Disclaimer:**The information provided on this page represents TI's knowledge and belief as of the date that it is provided. TI bases its knowledge and belief on information provided by third parties, and makes no representation or warranty as to the accuracy of such information. Efforts are underway to better integrate information from third parties. TI has taken and continues to take reasonable steps to provide representative and accurate information but may not have conducted destructive testing or chemical analysis on incoming materials and chemicals. TI and TI suppliers consider certain information to be proprietary, and thus CAS numbers and other limited information may not be available for release.

In no event shall TI's liability arising out of such information exceed the total purchase price of the TI part(s) at issue in this document sold by TI to Customer on an annual basis.

**TAPE AND REEL INFORMATION**

**QUADRANT ASSIGNMENTS FOR PIN 1 ORIENTATION IN TAPE**

\*All dimensions are nominal

Device	Package Type	Package Drawing	Pins	SPQ	Reel Diameter (mm)	Reel Width W1 (mm)	A0 (mm)	B0 (mm)	K0 (mm)	P1 (mm)	W (mm)	Pin1 Quadrant
LP38501ATJ-ADJ/NOPB	TO-263	NDQ	5	1000	330.0	24.4	10.6	15.4	2.45	12.0	24.0	Q2
LP38501TJ-ADJ/NOPB	TO-263	NDQ	5	1000	330.0	24.4	10.6	15.4	2.45	12.0	24.0	Q2
LP38501TSX-ADJ/NOPB	DDPAK/ TO-263	KTT	5	500	330.0	24.4	10.75	14.85	5.0	16.0	24.0	Q2
LP38503ATJ-ADJ/NOPB	TO-263	NDQ	5	1000	330.0	24.4	10.6	15.4	2.45	12.0	24.0	Q2
LP38503TJ-ADJ/NOPB	TO-263	NDQ	5	1000	330.0	24.4	10.6	15.4	2.45	12.0	24.0	Q2
LP38503TSX-ADJ/NOPB	DDPAK/ TO-263	KTT	5	500	330.0	24.4	10.75	14.85	5.0	16.0	24.0	Q2

**TAPE AND REEL BOX DIMENSIONS**

\*All dimensions are nominal

Device	Package Type	Package Drawing	Pins	SPQ	Length (mm)	Width (mm)	Height (mm)
LP38501ATJ-ADJ/NOPB	TO-263	NDQ	5	1000	367.0	367.0	35.0
LP38501TJ-ADJ/NOPB	TO-263	NDQ	5	1000	367.0	367.0	35.0
LP38501TSX-ADJ/NOPB	DDPAK/TO-263	KTT	5	500	367.0	367.0	45.0
LP38503ATJ-ADJ/NOPB	TO-263	NDQ	5	1000	367.0	367.0	35.0
LP38503TJ-ADJ/NOPB	TO-263	NDQ	5	1000	367.0	367.0	35.0
LP38503TSX-ADJ/NOPB	DDPAK/TO-263	KTT	5	500	367.0	367.0	45.0



NDQ0005A

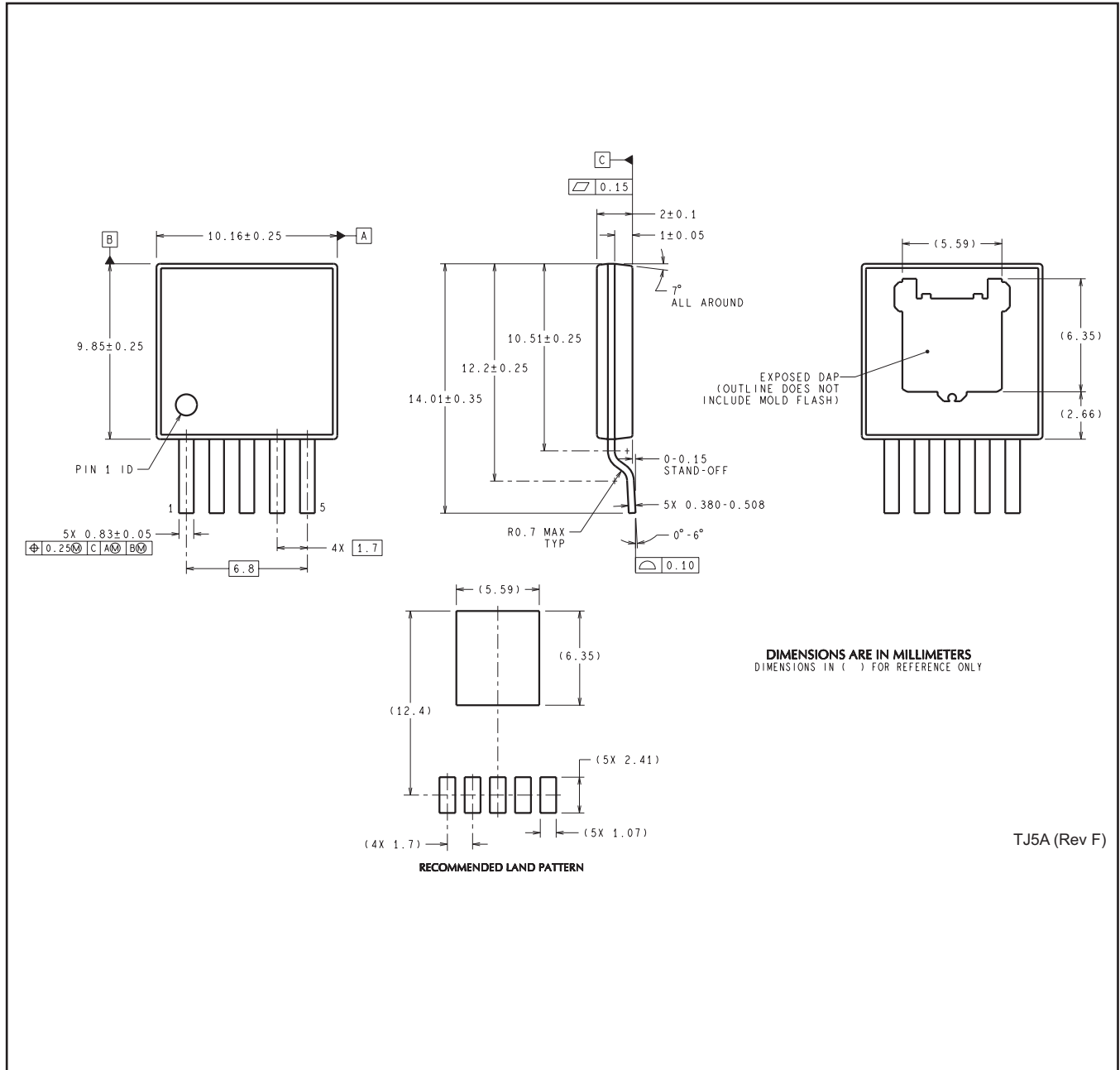

TJ5A (Rev F)

KTT0005B



CONTROLLING DIMENSION IS INCH  
 VALUES IN [ ] ARE MILLIMETERS  
 DIMENSIONS IN ( ) FOR REFERENCE ONLY

TS5B (Rev D)

## IMPORTANT NOTICE AND DISCLAIMER

TI PROVIDES TECHNICAL AND RELIABILITY DATA (INCLUDING DATASHEETS), DESIGN RESOURCES (INCLUDING REFERENCE DESIGNS), APPLICATION OR OTHER DESIGN ADVICE, WEB TOOLS, SAFETY INFORMATION, AND OTHER RESOURCES "AS IS" AND WITH ALL FAULTS, AND DISCLAIMS ALL WARRANTIES, EXPRESS AND IMPLIED, INCLUDING WITHOUT LIMITATION ANY IMPLIED WARRANTIES OF MERCHANTABILITY, FITNESS FOR A PARTICULAR PURPOSE OR NON-INFRINGEMENT OF THIRD PARTY INTELLECTUAL PROPERTY RIGHTS.

These resources are intended for skilled developers designing with TI products. You are solely responsible for (1) selecting the appropriate TI products for your application, (2) designing, validating and testing your application, and (3) ensuring your application meets applicable standards, and any other safety, security, or other requirements. These resources are subject to change without notice. TI grants you permission to use these resources only for development of an application that uses the TI products described in the resource. Other reproduction and display of these resources is prohibited. No license is granted to any other TI intellectual property right or to any third party intellectual property right. TI disclaims responsibility for, and you will fully indemnify TI and its representatives against, any claims, damages, costs, losses, and liabilities arising out of your use of these resources.

TI's products are provided subject to TI's Terms of Sale ([www.ti.com/legal/termsofsale.html](http://www.ti.com/legal/termsofsale.html)) or other applicable terms available either on [ti.com](http://ti.com) or provided in conjunction with such TI products. TI's provision of these resources does not expand or otherwise alter TI's applicable warranties or warranty disclaimers for TI products.

Mailing Address: Texas Instruments, Post Office Box 655303, Dallas, Texas 75265  
Copyright © 2020, Texas Instruments Incorporated