

THIS DRAWING IS UNPUBLISHED. RELEASED FOR PUBLICATION
 © COPYRIGHT - By - ALL RIGHTS RESERVED.

LOC	DIST	REVISIONS					
		P	LTR	DESCRIPTION	DATE	DWN	APVD
-	-		D9	REVISED PER ECO-12-012202	03JUL12	KH	MS







PHYSICAL PROPERTIES:
 HOUSING MATERIAL: PBT
 FLAMMABILITY: UL94V-0
 COLOR: BLACK











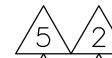

TERMINAL:
 TERMINALS: BRASS, TIN PLATED
 SCREWS: 6-32, STEEL, NICKEL PLATED

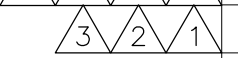
MECHANICAL:
 PITCH (TERMINAL SPACING): 9.50mm (.374")
 WIRE RANGE: 12-22 AWG
 RECOMMENDED TIGHTENING TORQUE: 12IN-LBS MAX.

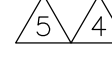
ELECTRICAL PROPERTIES:
 MAXIMUM CURRENT: 20A
 OPERATING VOLTAGE: 300V

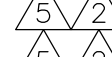
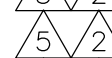
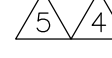
ENVIRONMENTAL PROPERTIES:
 OPERATING TEMP RANGE: -40°C TO 120°C

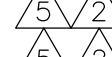
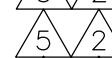
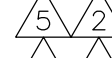
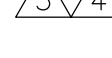
-  SCREWS ON ONE SIDE IN WIRE READY POSITION.
-  SEE FIGURE.
-  WHITE INK STAMP.
-  NICKEL PLATED BRASS SCREWS.
-  PRELIMINARY PART NUMBER.
-  TE CONNECTIVITY LOGO LOCATED APPROXIMATE AREA SHOWN.

LOC	DIST	DIM B	DIM A	QC TAB .187 45°	QC TAB .187 FLAT	NO OF POSN	PART NUMBER
		104.7	112.2	-	-	10	4-1546307-7
		104.7	112.2	-	-	10	4-1546307-6
		104.7	112.2	-	-	10	4-1546307-5
		104.7	112.2	-	-	10	3-1546307-3
		104.7	112.2	-	-	10	1-1546307-0
		95.2	102.7	-	9	9	5-1546307-0
		95.2	102.7	4	9	9	4-1546307-9
		95.2	102.7	4	9	9	4-1546307-8
		95.2	102.7	-	-	9	1546307-9
		85.7	93.2	-	-	8	1546307-8
		76.2	83.7	-	-	7	1546307-7
		66.7	74.2	-	-	6	4-1546307-4
		66.7	74.2	-	-	6	1546307-6
		57.2	64.7	-	-	5	4-1546307-3
		57.2	64.7	-	-	5	4-1546307-2
		57.2	64.7	-	-	5	4-1546307-1
		57.2	64.7	-	-	5	4-1546307-0
		57.2	64.7	-	-	5	3-1546307-9
		57.2	64.7	-	-	5	1546307-5
		47.7	55.2	-	-	4	3-1546307-2
		47.7	55.2	-	-	4	1546307-4
		38.2	45.7	-	-	3	3-1546307-8
		38.2	45.7	-	-	3	3-1546307-7
		38.2	45.7	-	-	3	3-1546307-6
		38.2	45.7	-	-	3	3-1546307-5
		38.2	45.7	-	-	3	3-1546307-4
		38.2	45.7	-	-	3	1546307-3
		28.7	36.2	-	-	2	1546307-2

THIS DRAWING IS A CONTROLLED DOCUMENT.		DWN S SCHLEGEL 20AUG2002	 TE Connectivity			
DIMENSIONS: mm		CHK C RICHARD 8/20/02				
TOLERANCES UNLESS OTHERWISE SPECIFIED:		APVD C RICHARD 8/20/02	NAME 9.50MM (.374) DBL ROW BARRIER STRIP W/ WASHER			
0 PLC ± - 1 PLC ± 0.3 2 PLC ± 0.25 3 PLC ± - 4 PLC ± - ANGLES ± 2'		PRODUCT SPEC	APPLICATION SPEC			
MATERIAL		WEIGHT -	SIZE A3	CAGE CODE 00779	DRAWING NO C-1546307	RESTRICTED TO
FINISH		CUSTOMER DRAWING		SCALE 1:1	SHEET 1 OF 3	REV D9

THIS DRAWING IS UNPUBLISHED. RELEASED FOR PUBLICATION
 © COPYRIGHT - By - ALL RIGHTS RESERVED.

LOC	DIST	REVISIONS			
P	LTR	DESCRIPTION	DATE	DWN	APVD
-	-	SEE SHEET 1	-	-	-

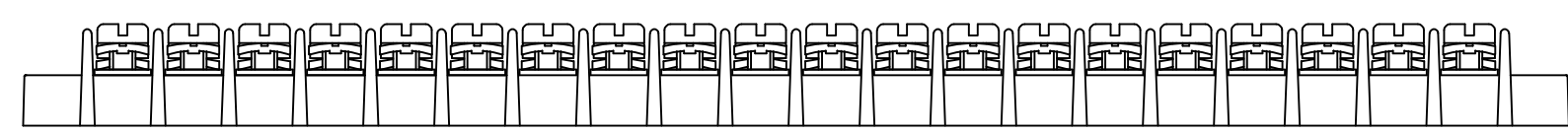

3-1546307-1

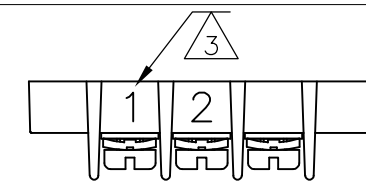
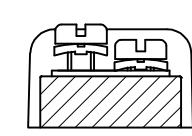

3-1546307-5

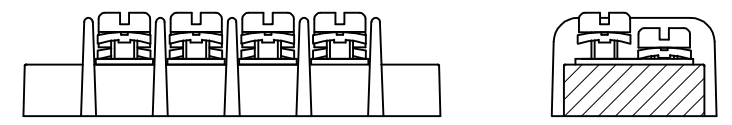

3-1546307-2

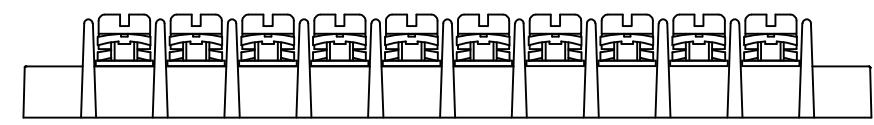
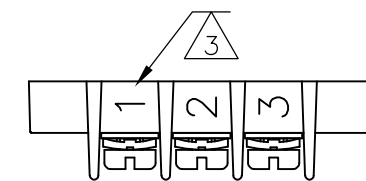
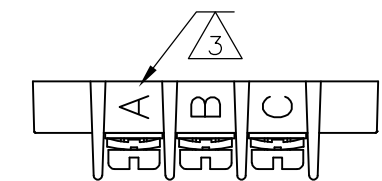
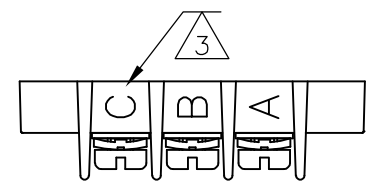
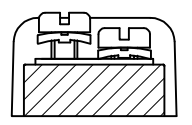

3-1546307-3

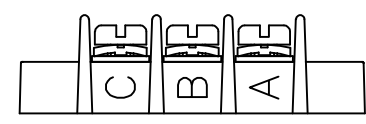
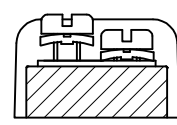

3-1546307-7

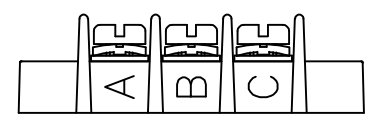

3-1546307-8

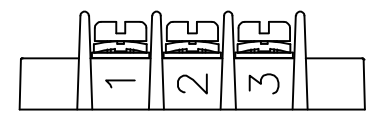

3-1546307-6

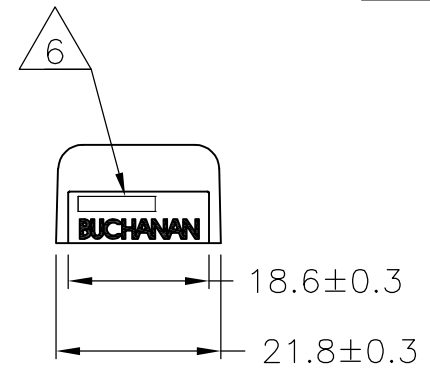
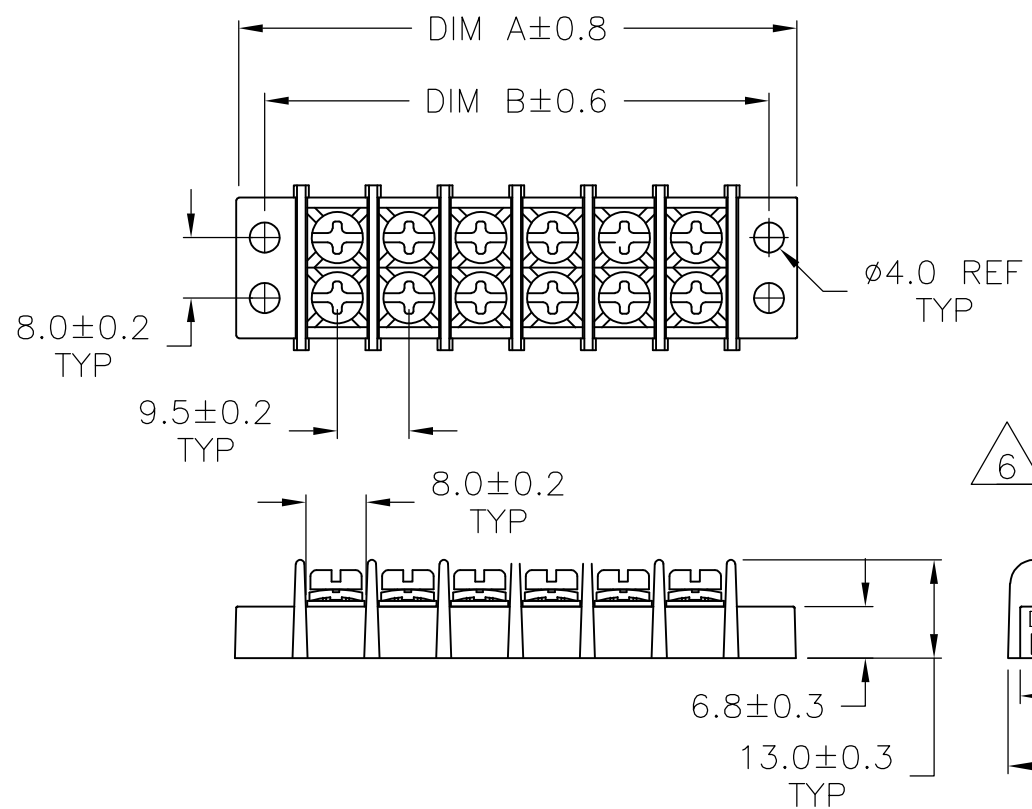

294.7	302.2	-	-	30	3-1546307-0
285.2	292.7	-	-	29	2-1546307-9
275.7	283.2	-	-	28	2-1546307-8
266.2	273.7	-	-	27	2-1546307-7
256.7	264.2	-	-	26	2-1546307-6
247.2	254.7	-	-	25	2-1546307-5
237.7	245.2	-	-	24	2-1546307-4
228.2	235.7	-	-	23	2-1546307-3
218.7	226.2	-	-	22	2-1546307-2
209.2	216.7	-	-	21	2-1546307-1
199.7	207.2	-	-	20	3-1546307-1
199.7	207.2	-	-	20	2-1546307-0
190.2	197.7	-	-	19	1-1546307-9
180.7	188.2	-	-	18	1-1546307-8
171.2	178.7	-	-	17	1-1546307-7
161.7	169.2	-	-	16	1-1546307-6
152.2	159.7	-	-	15	1-1546307-5
142.7	150.2	-	-	14	1-1546307-4
133.2	140.7	-	-	13	1-1546307-3
123.7	131.2	-	-	12	1-1546307-2
114.2	121.7	-	-	11	1-1546307-1
DIM B	DIM A	QC TAB .187 45° (2)	QC TAB .187 FLAT (1)	NO OF POSN	PART NUMBER

THIS DRAWING IS A CONTROLLED DOCUMENT.

DIMENSIONS: mm

TOLERANCES UNLESS OTHERWISE SPECIFIED:

0 PLC	± -
1 PLC	± 0.3
2 PLC	± 0.25
3 PLC	± -
4 PLC	± -
ANGLES	± 2°

MATERIAL: - FINISH: -

DWN: S SCHLEGEL 20AUG2002
 CHK: C RICHARD 8/20/02
 APVD: C RICHARD 8/20/02

STE TE Connectivity

9.50MM (.374) DBL ROW BARRIER STRIP W/ WASHER

SIZE: A3 CAGE CODE: 00779 DRAWING NO: C-1546307 RESTRICTED TO: -

CUSTOMER DRAWING SCALE: 1:1 SHEET: 2 OF 3 REV: D9

THIS DRAWING IS UNPUBLISHED.

RELEASED FOR PUBLICATION

LOC - -

DIST - -

REVISIONS

© COPYRIGHT - By -

ALL RIGHTS RESERVED.

P

LTR

DESCRIPTION

DATE

DWN

APVD

SEE SHEET 1

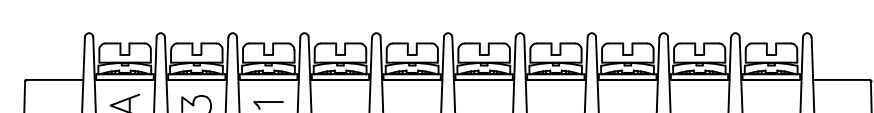
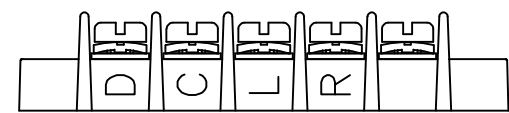
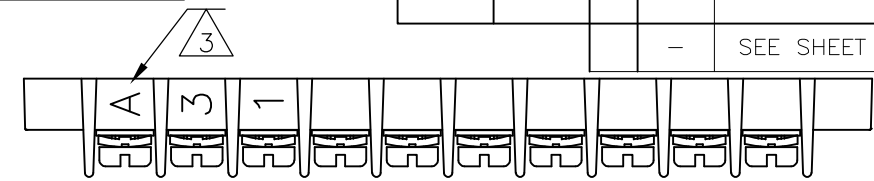
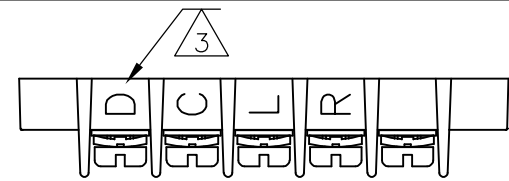
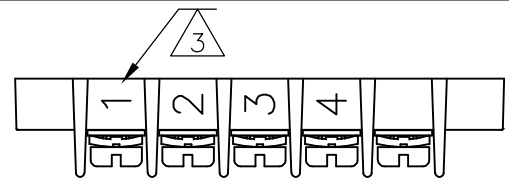

4-1546307-2

4-1546307-3

4-1546307-7

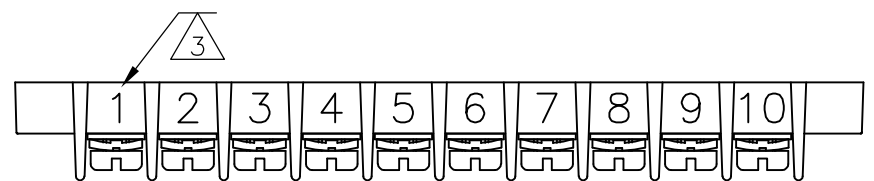

4-1546307-6

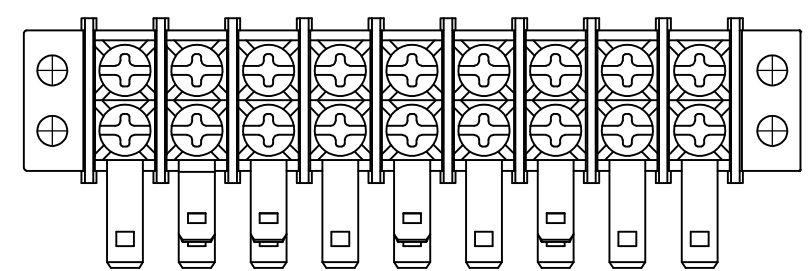

4-1546307-8

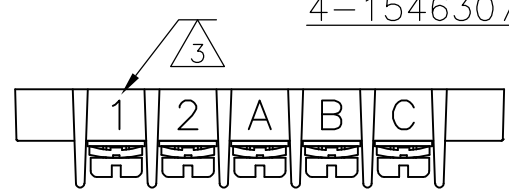

4-1546307-0

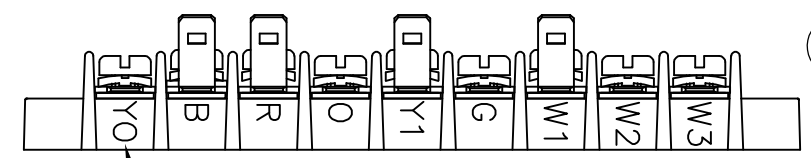

MARK BOTH SIDES

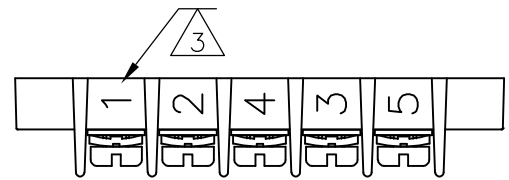

4-1546307-1

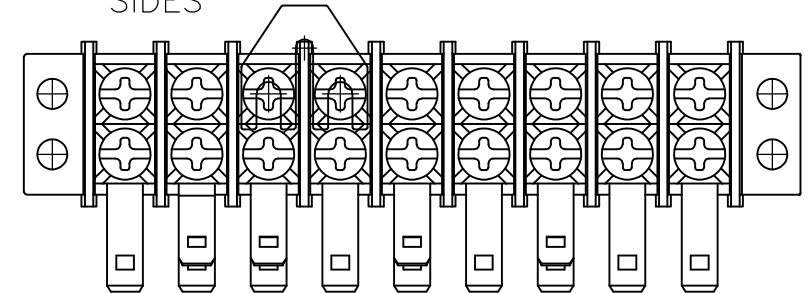

4-1546307-9

MARK BOTH SIDES

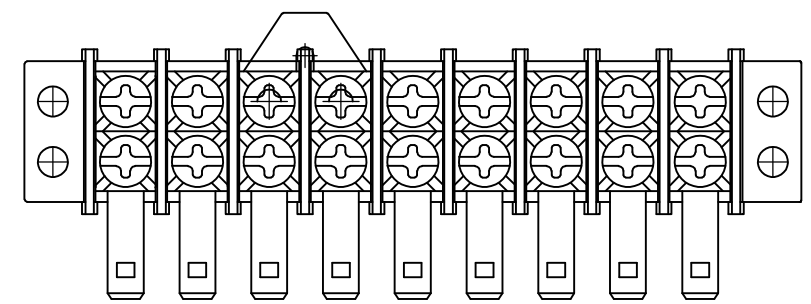

5-1546307-0

MARK BOTH SIDES

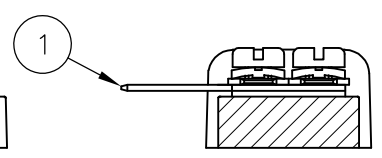
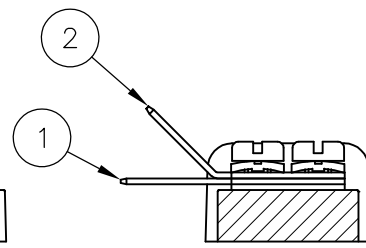
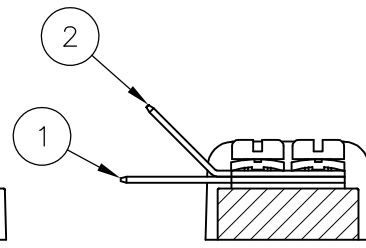

THIS DRAWING IS A CONTROLLED DOCUMENT.

DWN S SCHLEGEL 20AUG2002

CHK C RICHARD 8/20/02

APVD C RICHARD 8/20/02

PRODUCT SPEC

APPLICATION SPEC

WEIGHT -

CUSTOMER DRAWING



9.50MM (.374) DBL ROW BARRIER STRIP W/ WASHER

SIZE A3 CAGE CODE 00779 DRAWING NO C-1546307 RESTRICTED TO -

SCALE 1:1 SHEET 3 OF 3 REV D9

DIMENSIONS: mm

TOLERANCES UNLESS OTHERWISE SPECIFIED:

0 PLC	± -
1 PLC	± 0.3
2 PLC	± 0.25
3 PLC	± -
4 PLC	± -
ANGLES	± 2'

MATERIAL -

FINISH -

Mouser Electronics

Authorized Distributor

Click to View Pricing, Inventory, Delivery & Lifecycle Information:

[TE Connectivity:](#)

[1546307-4](#)