

LOC	DIST	REVISIONS			
P	LTR	DESCRIPTION	DATE	DWN	APVD
E	B	BA1	REVISED PER ECO-11-005150	28MAR2011	RK HMR

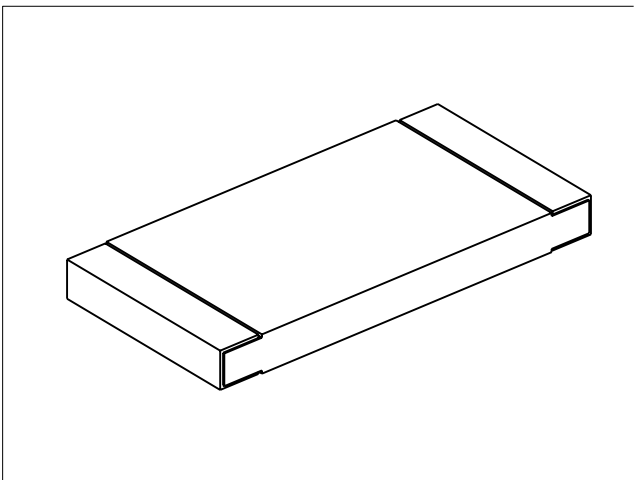

FOR FURTHER INFORMATION SEE DATA SHEET FOR
3520 SERIES-SMD POWER RESISTORS

RoHS Compliant



2008

RELEASED FOR PUBLICATION

ALL RIGHTS RESERVED.

THIS DRAWING IS UNPUBLISHED.

BY -

© COPYRIGHT 2008

DIMENSIONS: mm	DWN SUBHASH.M	01-DEC-08	MATERIAL	-	FINISH	-				
	CHK PRAKASH.S	01-DEC-08	 TE Connectivity							
TOLERANCES UNLESS OTHERWISE SPECIFIED:	APVD STEPHEN.P	01-DEC-08								
	0 PLC ±0.2	PRODUCT SPEC	NAME SMD POWER RESISTOR SERIES 3520							
1 PLC ±0.1	APPLICATION SPEC									
2 PLC ±	WEIGHT	-	SIZE	A 4	CAGE CODE	00779	DRAWING NO	C-1622820	RESTRICTED TO	-
3 PLC ±	CUSTOMER DRAWING		SCALE	10:1	SHEET	1	OF	1	REV	BA1
4 PLC ±										
ANGLES ±5°										

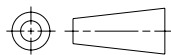

Mouser Electronics

Authorized Distributor

Click to View Pricing, Inventory, Delivery & Lifecycle Information:

[TE Connectivity:](#)

[3520150RJT](#)