

IR2125(S) & (PbF)

Absolute Maximum Ratings

Absolute Maximum Ratings indicate sustained limits beyond which damage to the device may occur. All voltage parameters are absolute voltages referenced to COM. The Thermal Resistance and Power Dissipation ratings are measured under board mounted and still air conditions.

| Symbol | Definition | Min. | Max. | Units |
|---------------------|--|----------------------|-----------------------|-------|
| V _B | High Side Floating Supply Voltage | -0.3 | 525 | V |
| V _S | High Side Floating Offset Voltage | V _B - 25 | V _B + 0.3 | |
| V _{HO} | High Side Floating Output Voltage | V _S - 0.3 | V _B + 0.3 | |
| V _{CC} | Logic Supply Voltage | -0.3 | 25 | |
| V _{IN} | Logic Input Voltage | -0.3 | V _{CC} + 0.3 | |
| V _{ERR} | Error Signal Voltage | -0.3 | V _{CC} + 0.3 | |
| V _{CS} | Current Sense Voltage | V _S - 0.3 | V _B + 0.3 | |
| dV _S /dt | Allowable Offset Supply Voltage Transient | — | 50 | V/ns |
| P _D | Package Power Dissipation @ T _A ≤ +25°C (8 lead PDIP) | — | 1.0 | W |
| | (16 lead SOIC) | — | 1.25 | |
| R _{thJA} | Thermal Resistance, Junction to Ambient (8 lead PDIP) | — | 125 | °C/W |
| | (16Lead SOIC) | — | 100 | |
| T _J | Junction Temperature | — | 150 | °C |
| T _S | Storage Temperature | -55 | 150 | |
| T _L | Lead Temperature (Soldering, 10 seconds) | — | 300 | |

Recommended Operating Conditions

The Input/Output logic timing diagram is shown in Figure 1. For proper operation the device should be used within the recommended conditions. The V_S offset rating is tested with all supplies biased at 15V differential.

| Symbol | Definition | Min. | Max. | Units |
|------------------|-----------------------------------|---------------------|---------------------|-------|
| V _B | High Side Floating Supply Voltage | V _S + 12 | V _S + 18 | V |
| V _S | High Side Floating Offset Voltage | Note 1 | 500 | |
| V _{HO} | High Side Floating Output Voltage | V _S | V _B | |
| V _{CC} | Logic Supply Voltage | 0 | 18 | |
| V _{IN} | Logic Input Voltage | 0 | V _{CC} | |
| V _{ERR} | Error Signal Voltage | 0 | V _{CC} | |
| V _{CS} | Current Sense Signal Voltage | V _S | V _B | |
| T _A | Ambient Temperature | -40 | 125 | °C |

Note 1: Logic operational for V_S of -5 to +500V. Logic state held for V_S of -5V to -V_{BS}. (Please refer to the Design Tip DT97-3 for more details).

Dynamic Electrical Characteristics

$V_{BIAS} (V_{CC}, V_{BS}) = 15V$, $C_L = 3300 \text{ pF}$ and $T_A = 25^\circ\text{C}$ unless otherwise specified. The dynamic electrical characteristics are measured using the test circuit shown in Figures 3 through 6.

| Symbol | Definition | Figure | Min. | Typ. | Max. | Units | Test Conditions |
|-----------|-------------------------------------|--------|------|------|------|---------------|---|
| t_{on} | Turn-On Propagation Delay | 7 | — | 170 | 240 | ns | $V_{IN} = 0 \text{ \& } 5V$ $V_S = 0 \text{ to } 600V$ |
| t_{off} | Turn-Off Propagation Delay | 8 | — | 200 | 270 | | |
| t_{sd} | ERR Shutdown Propagation Delay | 9 | — | 1.7 | 2.2 | μs | |
| t_r | Turn-On Rise Time | 10 | — | 43 | 60 | ns | |
| t_f | Turn-Off Fall Time | 11 | — | 26 | 35 | | |
| t_{cs} | CS Shutdown Propagation Delay | 12 | — | 0.7 | 1.2 | μs | |
| t_{err} | CS to ERR Pull-Up Propagation Delay | 13 | — | 9.0 | 12 | | $C_{ERR} = 270 \text{ pF}$ |

Static Electrical Characteristics

$V_{BIAS} (V_{CC}, V_{BS}) = 15V$ and $T_A = 25^\circ\text{C}$ unless otherwise specified. The V_{IN} , V_{TH} and I_{IN} parameters are referenced to COM. The V_O and I_O parameters are referenced to V_S .

| Symbol | Definition | Figure | Min. | Typ. | Max. | Units | Test Conditions | |
|-------------|---|--------|------|------|------|---------------|--|--|
| V_{IH} | Logic "1" Input Voltage | 14 | 2.2 | — | — | V | | |
| V_{IL} | Logic "0" Input Voltage | 15 | — | — | 0.8 | | | |
| V_{CSTH+} | CS Input Positive Going Threshold | 16 | 150 | 230 | 320 | mV | | |
| V_{CSTH-} | CS Input Negative Going Threshold | 17 | 130 | 210 | 300 | | | |
| V_{OH} | High Level Output Voltage, $V_{BIAS} - V_O$ | 18 | — | — | 100 | | $I_O = 0A$ | |
| V_{OL} | Low Level Output Voltage, V_O | 19 | — | — | 100 | | $I_O = 0A$ | |
| I_{LK} | Offset Supply Leakage Current | 20 | — | — | 50 | μA | $V_B = V_S = 500V$ | |
| I_{QBS} | Quiescent V_{BS} Supply Current | 21 | — | 400 | 1000 | | $V_{IN} = V_{CS} = 0V \text{ or } 5V$ | |
| I_{QCC} | Quiescent V_{CC} Supply Current | 22 | — | 700 | 1200 | | $V_{IN} = V_{CS} = 0V \text{ or } 5V$ | |
| I_{IN+} | Logic "1" Input Bias Current | 23 | — | 4.5 | 10 | | $V_{IN} = 5V$ | |
| I_{IN-} | Logic "0" Input Bias Current | 24 | — | — | 1.0 | | $V_{IN} = 0V$ | |
| I_{CS+} | "High" CS Bias Current | 25 | — | 4.5 | 10 | | $V_{CS} = 3V$ | |
| I_{CS-} | "Low" CS Bias Current | 26 | — | — | 1.0 | | $V_{CS} = 0V$ | |
| V_{BSUV+} | V_{BS} Supply Undervoltage Positive Going Threshold | 27 | 8.5 | 9.2 | 10.0 | | V | |
| V_{BSUV-} | V_{BS} Supply Undervoltage Negative Going Threshold | 28 | 7.7 | 8.3 | 9.0 | | | |
| V_{CCUV+} | V_{CC} Supply Undervoltage Positive Going Threshold | 29 | 8.3 | 8.9 | 9.6 | | | |
| V_{CCUV-} | V_{CC} Supply Undervoltage Negative Going Threshold | 30 | 7.3 | 8.0 | 8.7 | | | |
| I_{ERR} | ERR Timing Charge Current | 31 | 65 | 100 | 130 | μA | $V_{IN} = 5V, V_{CS} = 3V$ $ERR < V_{ERR+}$ | |
| I_{ERR+} | ERR Pull-Up Current | 32 | 8.0 | 15 | — | mA | $V_{IN} = 5V, V_{CS} = 3V$ $ERR > V_{ERR+}$ | |
| I_{ERR-} | ERR Pull-Down Current | 33 | 16 | 30 | — | | $V_{IN} = 0V$ | |
| I_{O+} | Output High Short Circuit Pulsed Current | 34 | 1.0 | 1.6 | — | A | $V_O = 0V, V_{IN} = 5V$ $PW \leq 10 \mu\text{s}$ | |
| I_{O-} | Output Low Short Circuit Pulsed Current | 35 | 2.0 | 3.3 | — | | $V_O = 15V, V_{IN} = 0V$ $PW \leq 10 \mu\text{s}$ | |

IR2125(S) & (PbF)

Functional Block Diagram

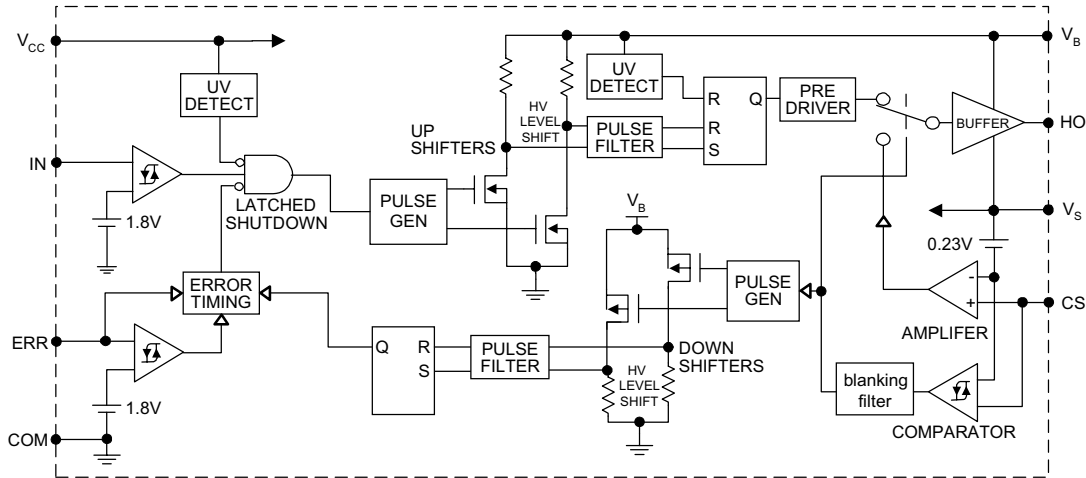

Lead Definitions

| Symbol | Description |
|-----------------|---|
| V _{CC} | Logic and gate drive supply |
| IN | Logic input for gate driver output (HO), in phase with HO |
| ERR | Serves multiple functions; status reporting, linear mode timing and cycle by cycle logic shutdown |
| COM | Logic ground |
| V _B | High side floating supply |
| HO | High side gate drive output |
| V _S | High side floating supply return |
| CS | Current sense input to current sense comparator |

Lead Assignments

| | |
|--------------------|---------------------------------|
| <p>8 Lead PDIP</p> | <p>16 Lead SOIC (Wide Body)</p> |
| IR2125 | IR2125S |
| Part Number | |

IR2125(S) & (PbF)

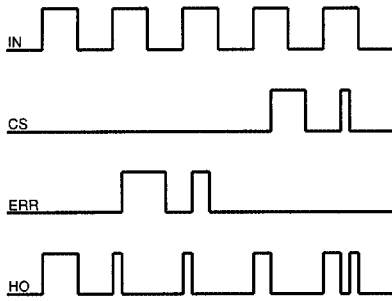

Figure 1. Input/Output Timing Diagram

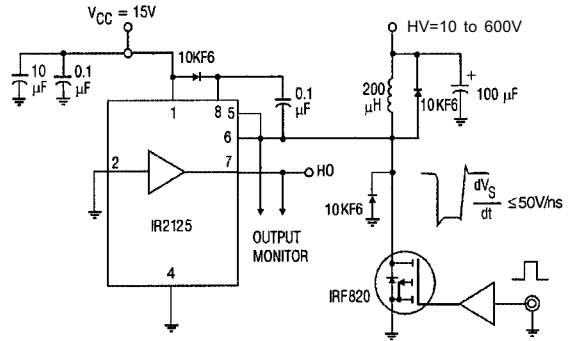

Figure 2. Floating Supply Voltage Transient Test Circuit

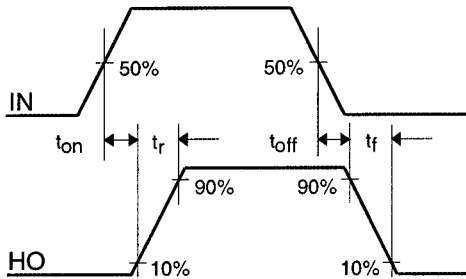

Figure 3. Switching Time Waveform Definitions

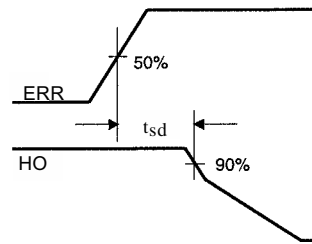

Figure 4. ERR Shutdown Waveform Definitions

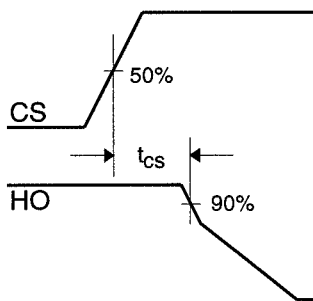

Figure 5. CS Shutdown Waveform Definitions

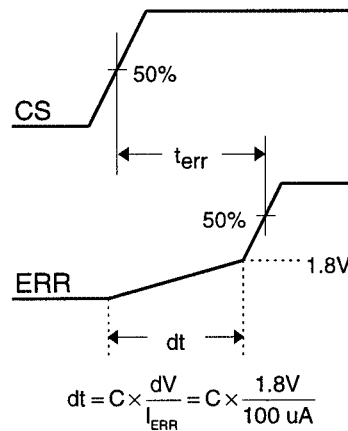

Figure 6. CS to ERR Waveform Definitions

IR2125(S) & (PbF)

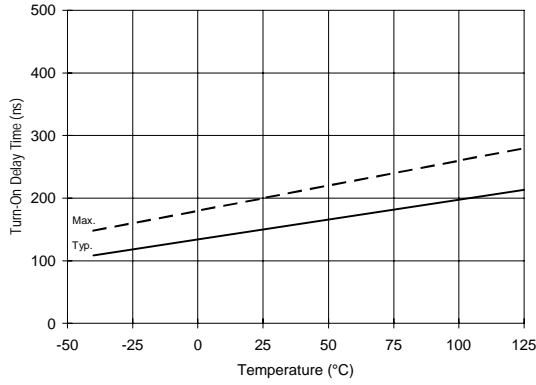

Figure 7A. Turn-On Time vs. Temperature

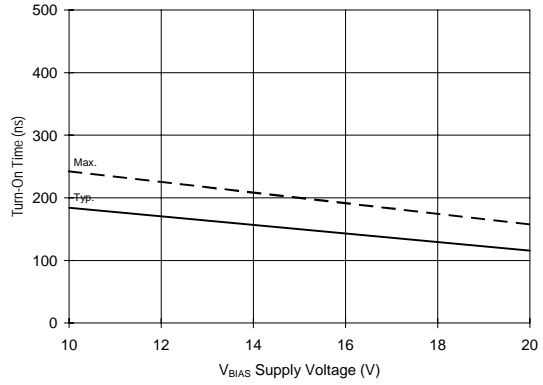

Figure 7B. Turn-On Time vs. Voltage

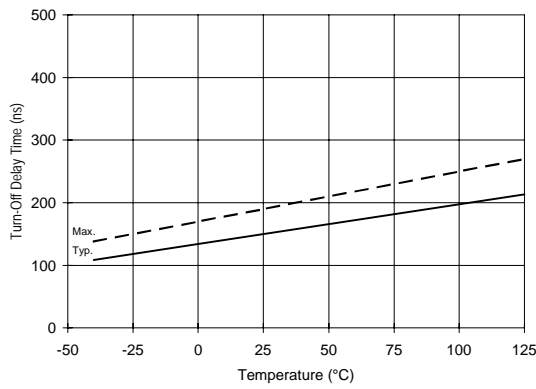

Figure 8A. Turn-Off Time vs. Temperature

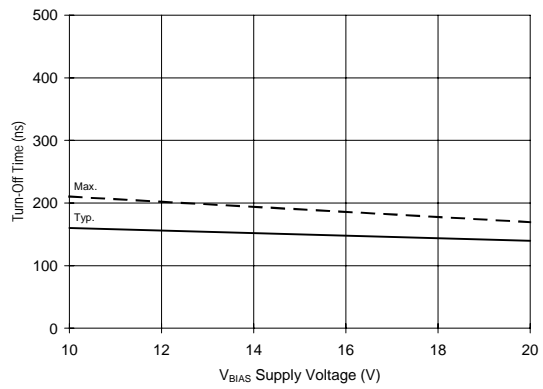

Figure 8B. Turn-Off Time vs. Voltage

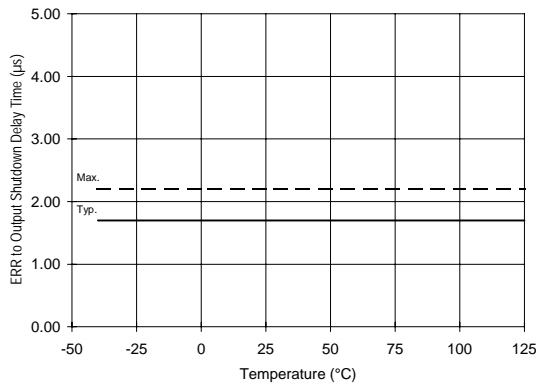

Figure 9A. ERR to Output Shutdown vs. Temperature

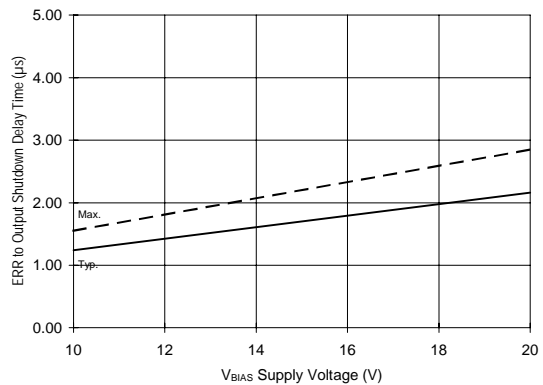

Figure 9B. ERR to Output Shutdown vs. Voltage



Figure 10A. Turn-On Rise Time vs. Temperature



Figure 10B. Turn-On Rise Time vs. Voltage



Figure 11A. Turn-Off Fall Time vs. Temperature



Figure 11B. Turn-Off Fall Time vs. Voltage

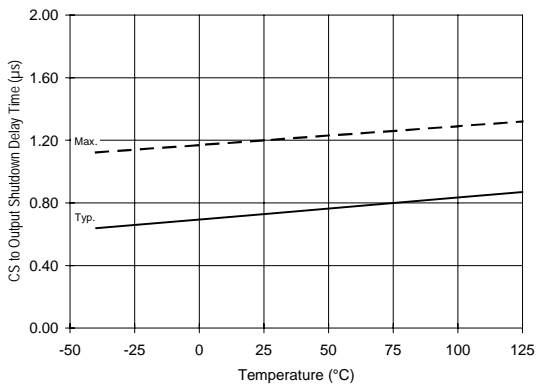

Figure 12A. CS to Output Shutdown vs. Temperature

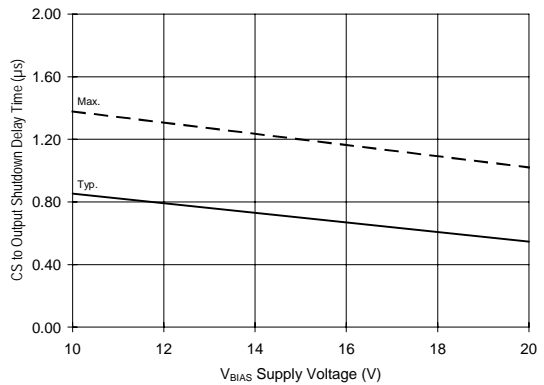

Figure 12B. CS to Output Shutdown vs. Voltage

IR2125(S) & (PbF)

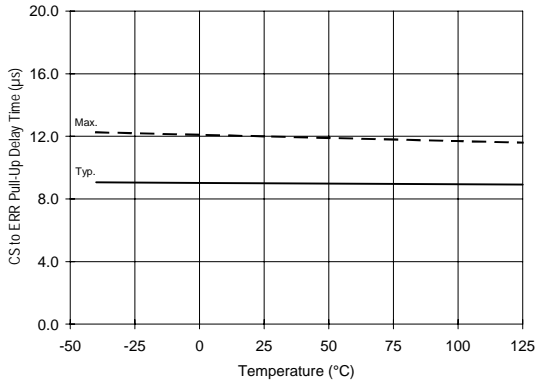

Figure 13A. CS to ERR Pull-Up vs. Temperature

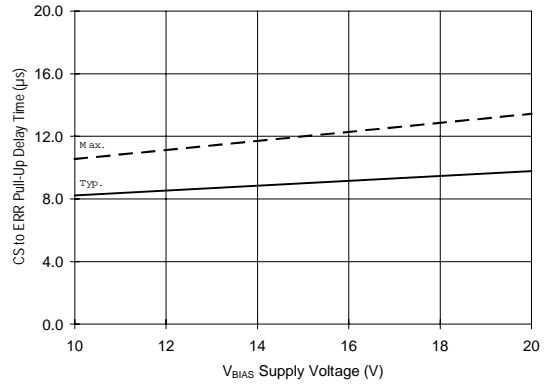

Figure 13B. CS to ERR Pull-Up vs. Voltage

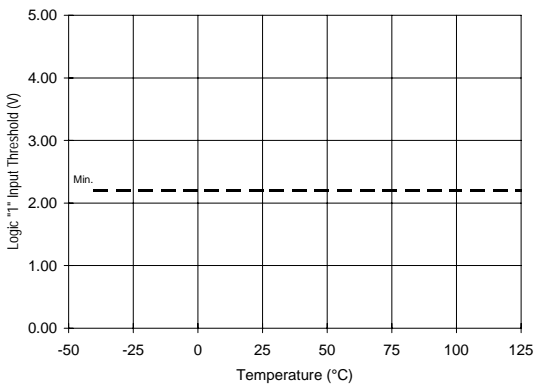

Figure 14A. Logic "1" Input Threshold vs. Temperature

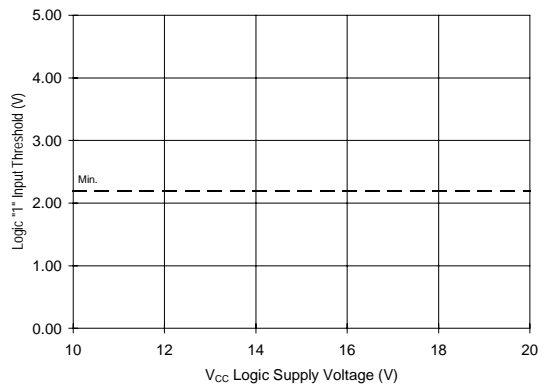

Figure 14B. Logic "1" Input Threshold vs. Voltage

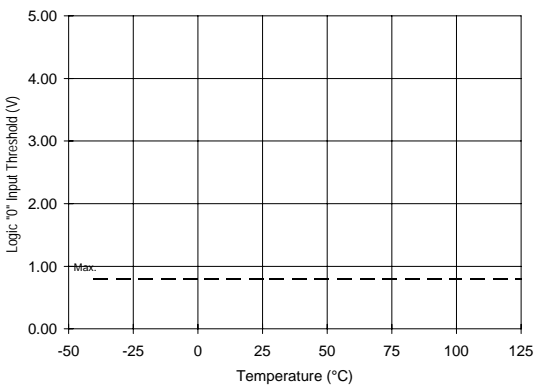

Figure 15A. Logic "0" Input Threshold vs. Temperature

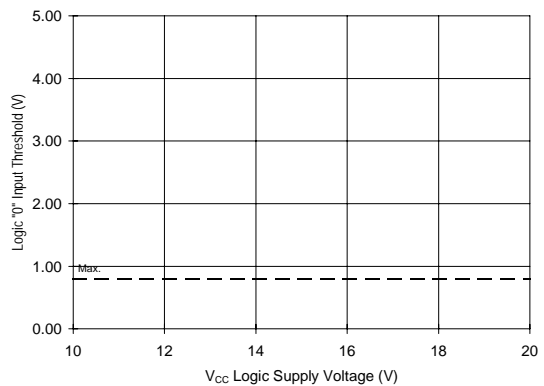

Figure 15B. Logic "0" Input Threshold vs. Voltage

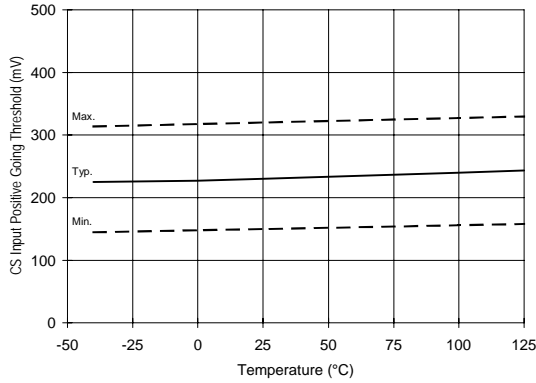

Figure 16A. CS Input Threshold (+) vs. Temperature

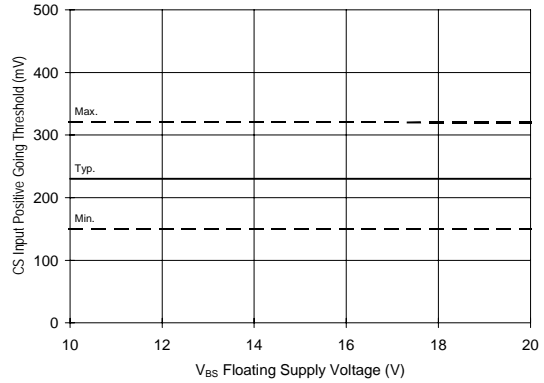

Figure 16B. CS Input Threshold (+) vs. Voltage

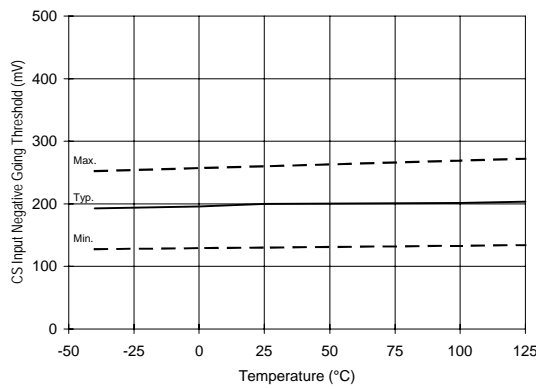

Figure 17A. CS Input Threshold (-) vs. Temperature

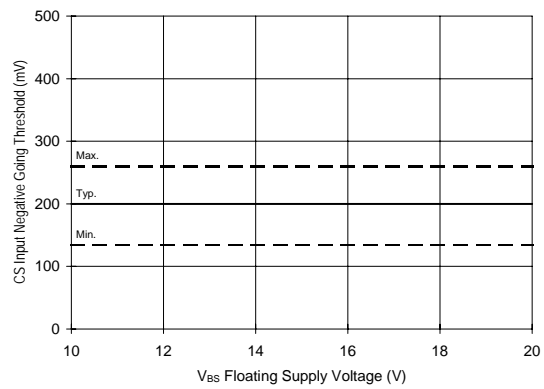

Figure 17B. CS Input Threshold (-) vs. Voltage

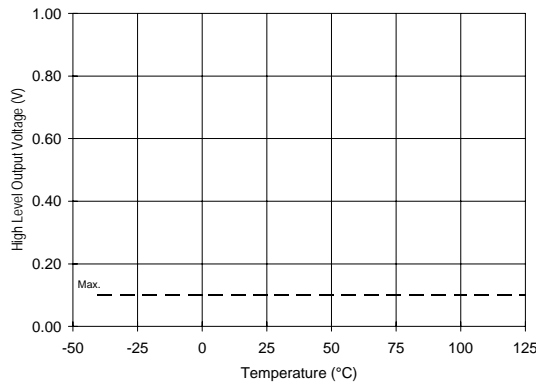

Figure 18A. High Level Output vs. Temperature

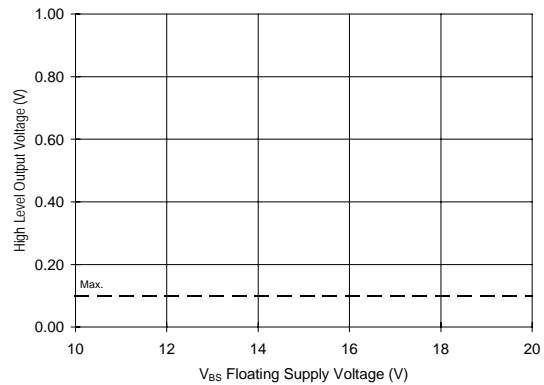

Figure 18B. High Level Output vs. Voltage

IR2125(S) & (PbF)

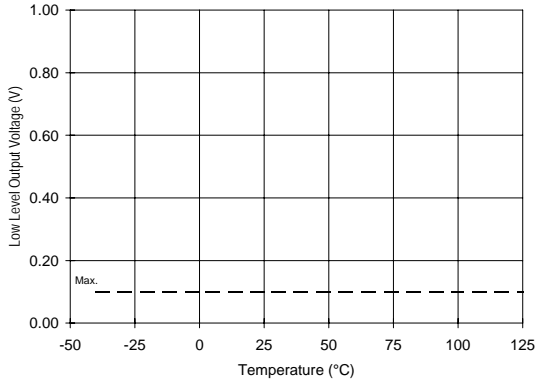

Figure 19A. Low Level Output vs. Temperature



Figure 19B. Low Level Output vs. Voltage

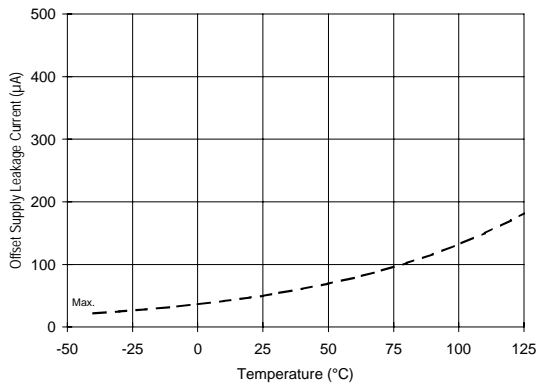

Figure 20A. Offset Supply Current vs. Temperature

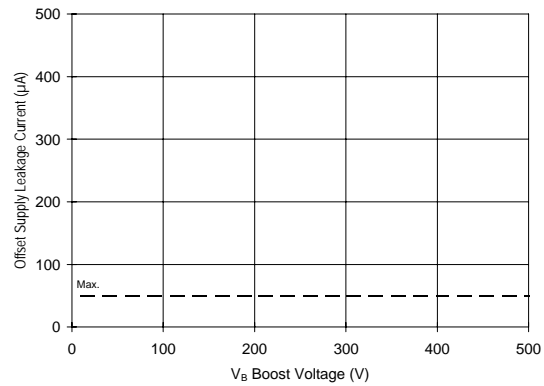

Figure 20B. Offset Supply Current vs. Voltage

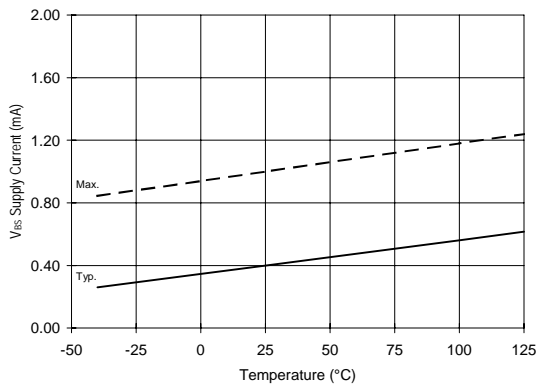

Figure 21A. V_{BS} Supply Current vs. Temperature



Figure 21B. V_{BS} Supply Current vs. Voltage

IR2125(S) & (PbF)

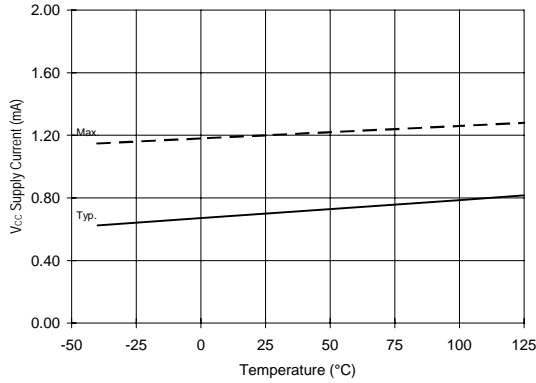

Figure 22A. V_{CC} Supply Current vs. Temperature



Figure 22B. V_{CC} Supply Current vs. Voltage

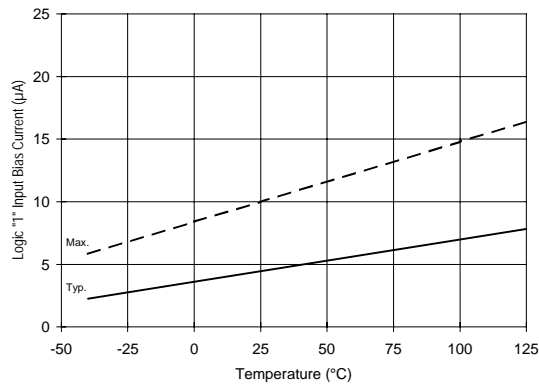

Figure 23A. Logic "1" Input Current vs. Temperature



Figure 23B. Logic "1" Input Current vs. Voltage

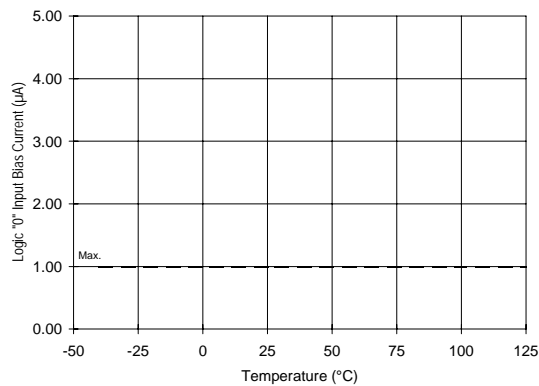

Figure 24A. Logic "0" Input Current vs. Temperature



Figure 24B. Logic "0" Input Current vs. Voltage

IR2125(S) & (PbF)

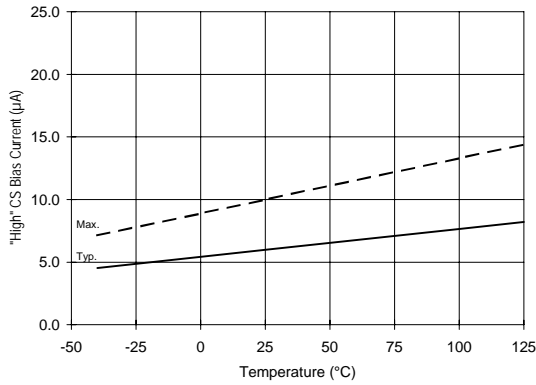

Figure 25A. "High" CS Bias Current vs. Temperature

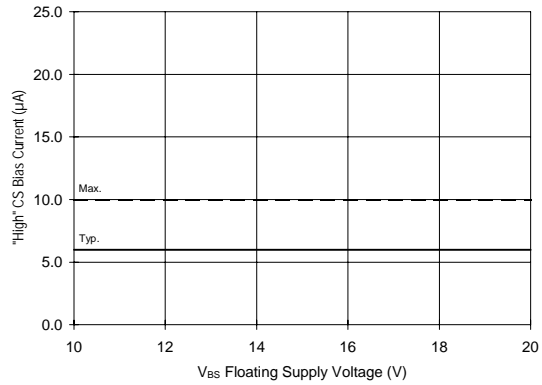

Figure 25B. "High" CS Bias Current vs. Voltage

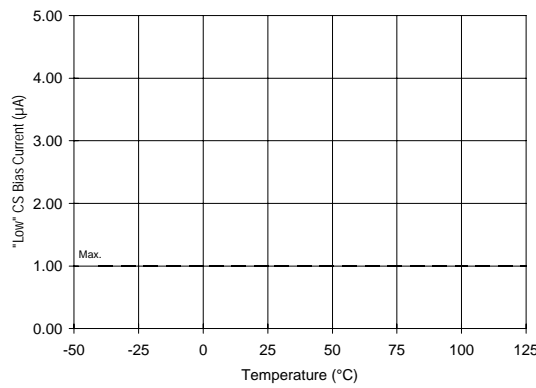

Figure 26A. "Low" CS Bias Current vs. Temperature

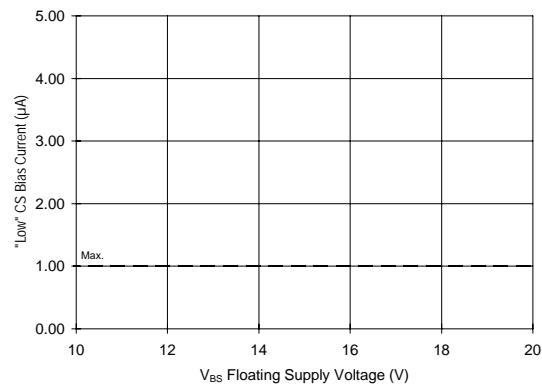

Figure 26B. "Low" CS Bias Current vs. Voltage

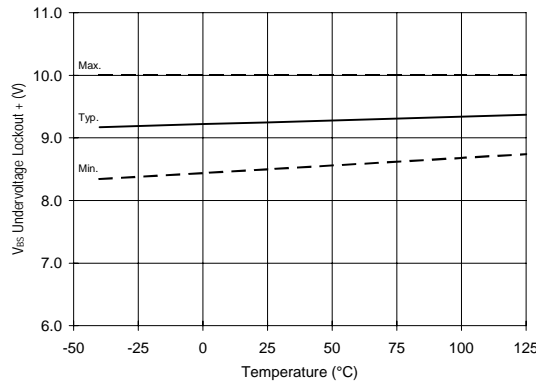

Figure 27. V_{BS} Undervoltage Lockout (+) vs. Temperature

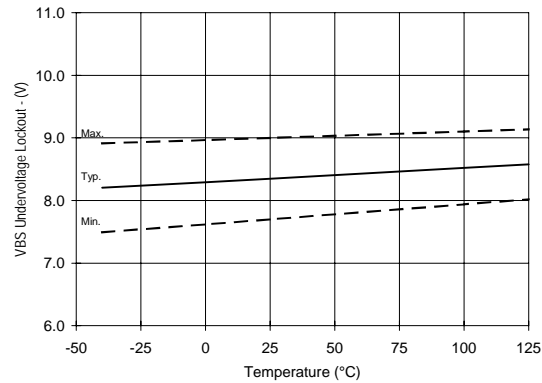

Figure 28. V_{BS} Undervoltage Lockout (-) vs. Temperature

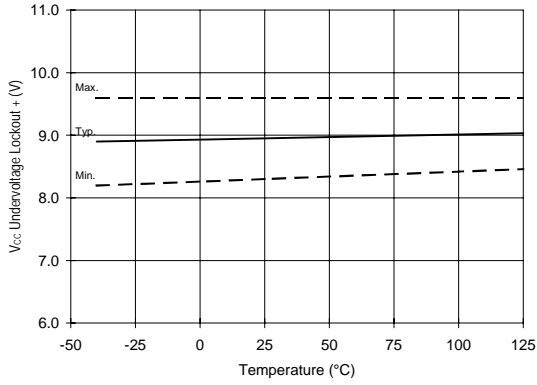

Figure 29. V_{CC} Undervoltage (+) vs. Temperature

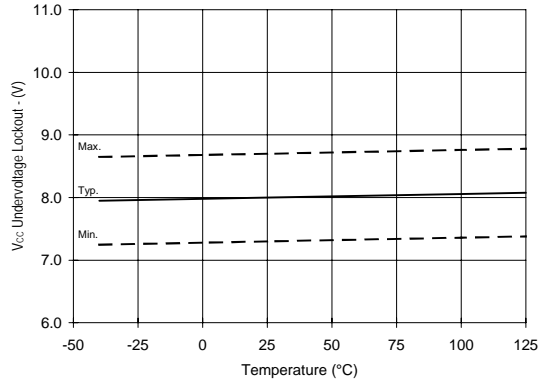

Figure 30. V_{CC} Undervoltage (-) vs. Temperature

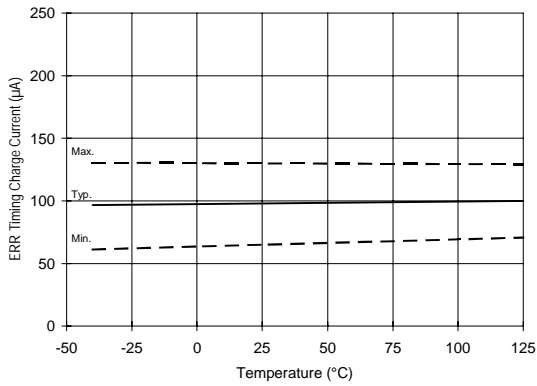

Figure 31A. ERR Timing Charge Current vs. Temperature

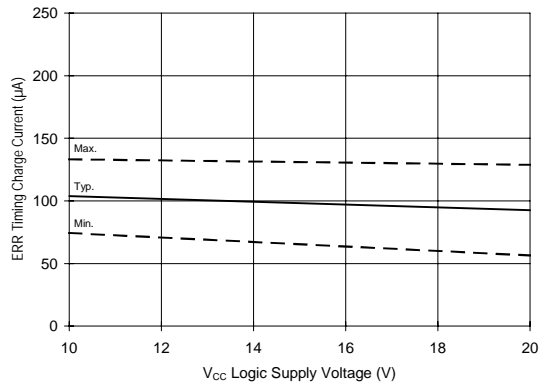

Figure 31B. ERR Timing Charge Current vs. Voltage

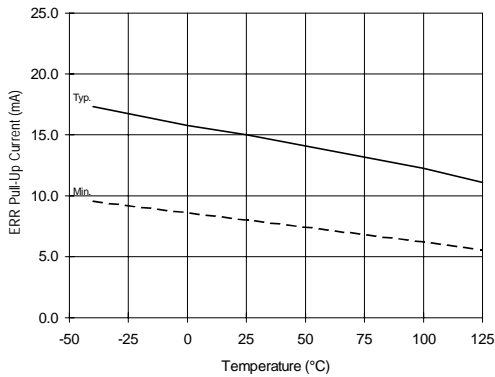

Figure 32A. ERR Pull-Up Current vs. Temperature

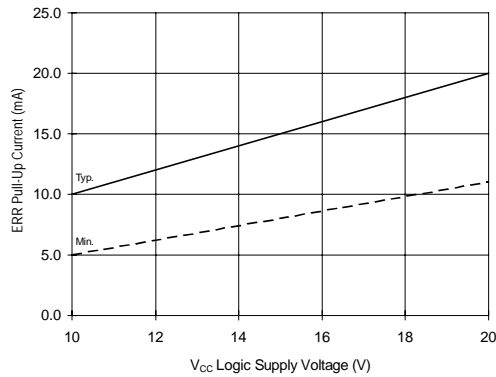

Figure 32B. ERR Pull-Up Current vs. Voltage

IR2125(S) & (PbF)



Figure 33A. ERR Pull-Down Current vs. Temperature

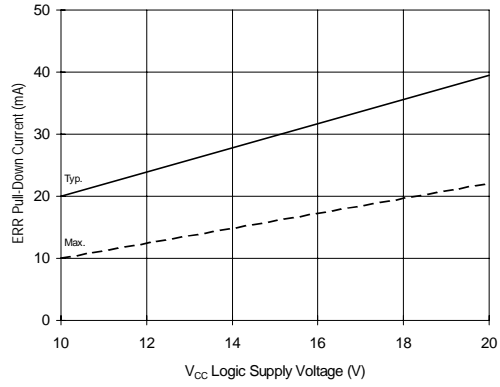

Figure 33B. ERR Pull-Down Current vs. Voltage



Figure 34A. Output Source Current vs. Temperature



Figure 34B. Output Source Current vs. Voltage

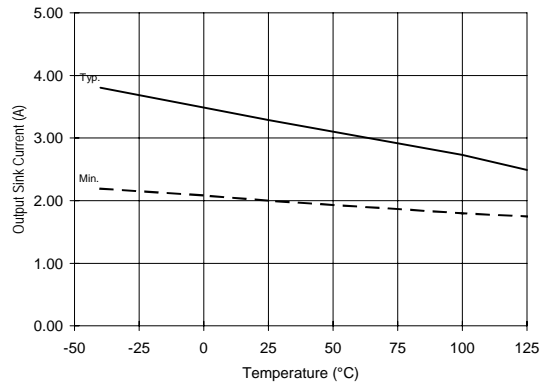

Figure 35A. Output Sink Current vs. Temperature

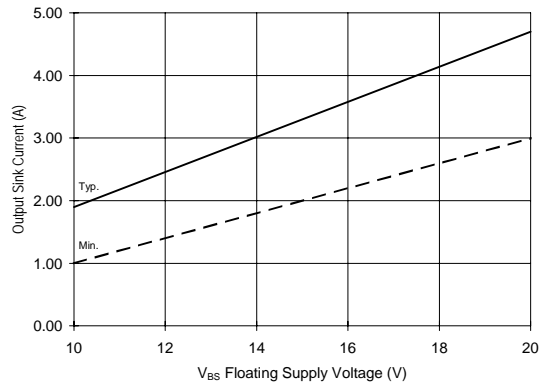

Figure 35B. Output Sink Current vs. Voltage



Figure 36A. Turn-On Time vs. Input Voltage

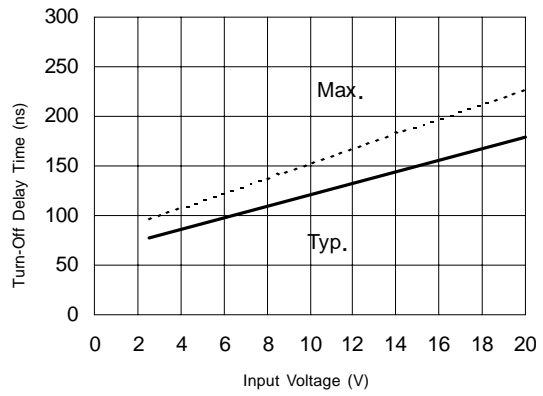

Figure 36B. Turn-Off Time vs. Input Voltage

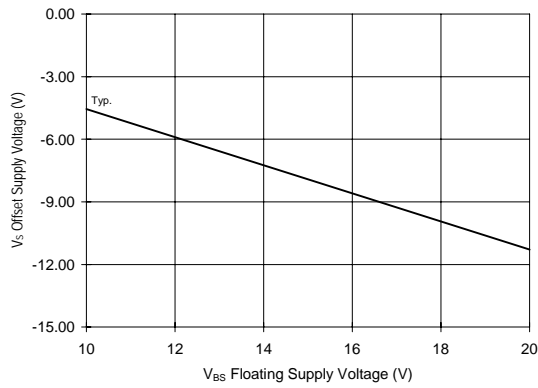
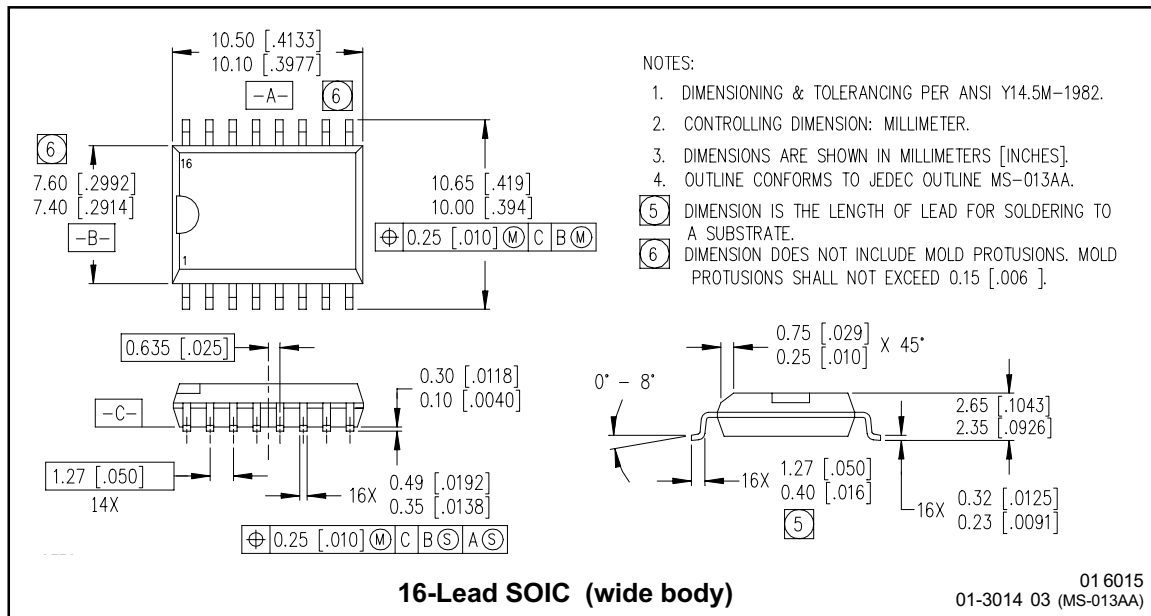
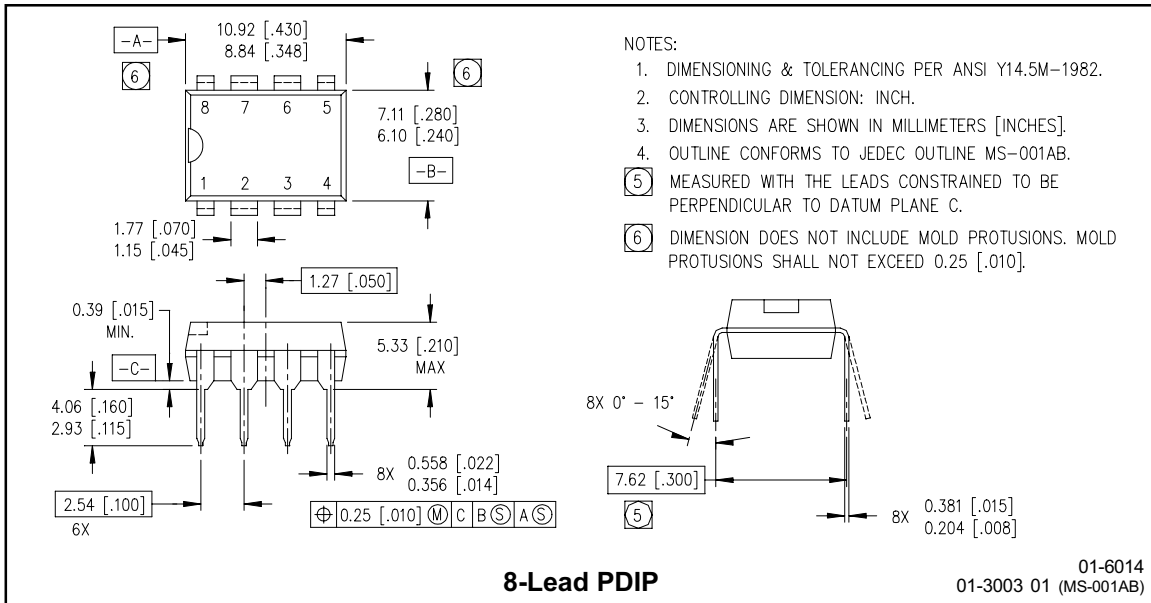

Figure 37. Maximum V_S Negative Offset vs. Supply Voltage

IR2125(S) & (PbF)

Case outlines



LEADFREE PART MARKING INFORMATION

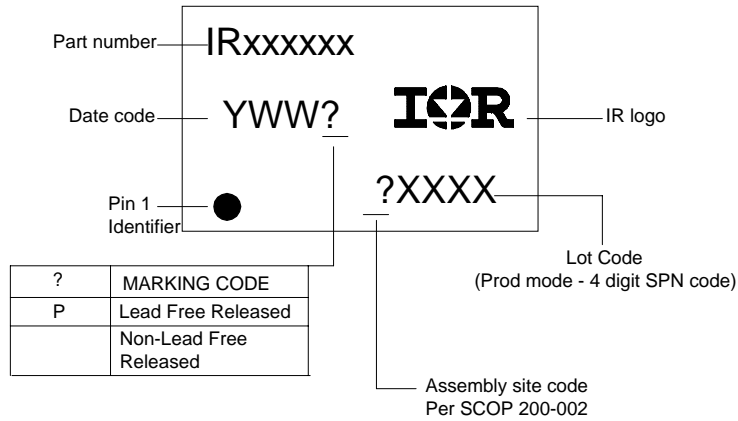

ORDER INFORMATION

Basic Part (Non-Lead Free)

8-Lead PDIP IR2125 order IR2125
 16-Lead SOIC IR2125S order IR2125S

Leadfree Part

8-Lead PDIP IR2125 order IR2125PbF
 16-Lead SOIC IR2125S order IR2125SPbF

Mouser Electronics

Authorized Distributor

Click to View Pricing, Inventory, Delivery & Lifecycle Information:

[Infineon:](#)

[IR2125PBF](#) [IR2125SPBF](#) [IR2125STRPBF](#)