

Description

General purpose metal to silicon diodes featuring very low turn-on voltage and fast switching.

Table 1. Device summary

Symbol	Value
$I_{F(AV)}$	0.1 A
V_{RRM}	30 V
T_j	150 °C
V_F (max)	0.33 and 0.40 V

Features

- Very small conduction losses
- Negligible switching losses
- Low forward voltage drop
- Surface mount device

1 Characteristics

Table 2. Absolute ratings (limiting values)

Symbol	Parameter	Value	Unit	
V _{DRM}	Repetitive peak off-state voltage	30	V	
I _{F(AV)}	Continuous forward current	0.1	A	
I _{FSM}	Surge non repetitive forward current	t _p = 10 ms sinusoidal	0.75	A
P _{tot}	Power dissipation ⁽¹⁾	T _{amb} = 25 °C	250	mW
T _{stg}	Maximum Storage temperature range	- 65 to + 150	°C	
T _j	Maximum operating junction temperature ⁽²⁾	150	°C	
T _L	Maximum temperature for soldering during 10 s	260	°C	

1. For double diodes, P_{tot} is the total dissipation of both diodes
2. $\frac{dP_{tot}}{dT_j} < \frac{1}{R_{th(j-a)}}$ condition to avoid thermal runaway for a diode on its own heatsink.

Table 3. Thermal parameter

Symbol	Parameter	Value	Unit
R _{th(j-a)}	Junction to ambient ⁽¹⁾	500	°C/W

1. Mounted on epoxy board with recommended pad layout.

Table 4. Static electrical characteristics

Symbol	Parameter	Test conditions		Min.	Typ.	Max.	Unit	
V _{BR}	Breakdown voltage	T _j = 25 °C	I _R = 100 μA	30			V	
I _R (1)	Reverse leakage current	T _j = 25 °C	V _R = V _{RRM}			500	nA	
		T _j = 100 °C				100	μA	
V _F (2)	Forward voltage drop	T _j = 25 °C	BAR42	I _F = 10 mA		0.35	0.40	V
				I _F = 50 mA		0.50	0.65	
			BAR43	I _F = 2 mA	0.26		0.33	
				I _F = 15 mA			0.45	
			ALL	I _F = 100 mA			1	

1. Pulse test: t_p = 5 ms, δ < 2 %
2. Pulse test: t_p = 380 μs, δ < 2 %

Table 5. Dynamic characteristics (Tj = 25 °C)

Symbol	Test conditions	Min.	Typ.	Max.	Unit
C	Junction capacitance T _j = 25 °C V _R = 1 V F = 1 MHz		7		pF
C	Reverse recovery time I _F = 10 mA I _R = 10 mA T _j = 25 °C I _{rr} = 1 mA R _L = 100 Ω			5	pF
η	Detection efficiency C _L = 300 pF F = 45 MHz T _j = 25 °C V _i = 2 V R _L = 50 Ω	80			ps

Figure 1. Forward voltage drop versus forward current (typical values, low level)

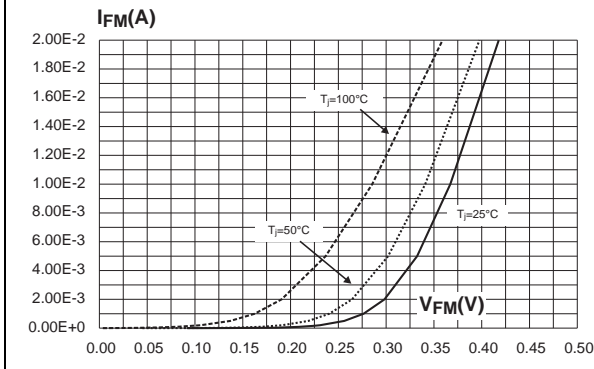

Figure 2. Forward voltage drop versus forward current (typical values, high level)

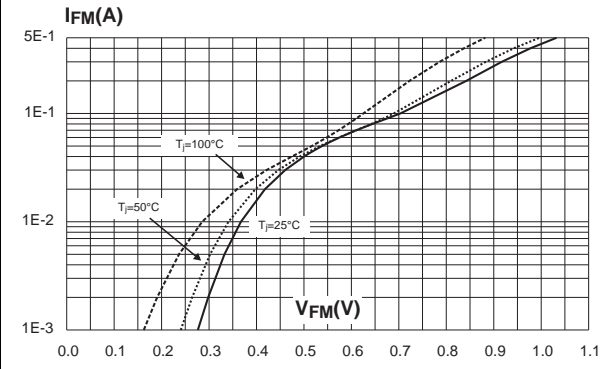

Figure 3. Reverse leakage current versus reverse voltage applied (typical values)

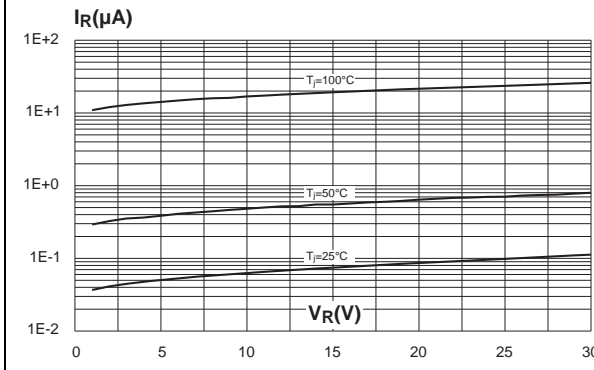
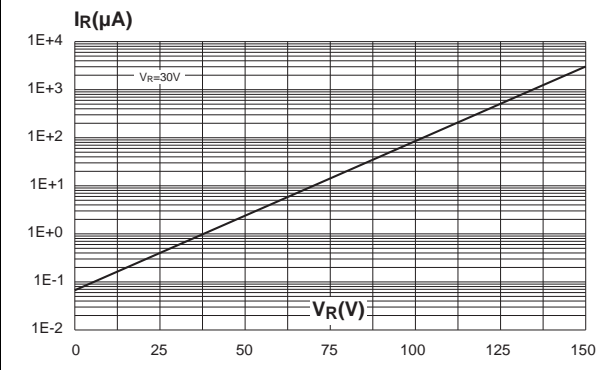

Figure 4. Reverse leakage current versus junction temperature



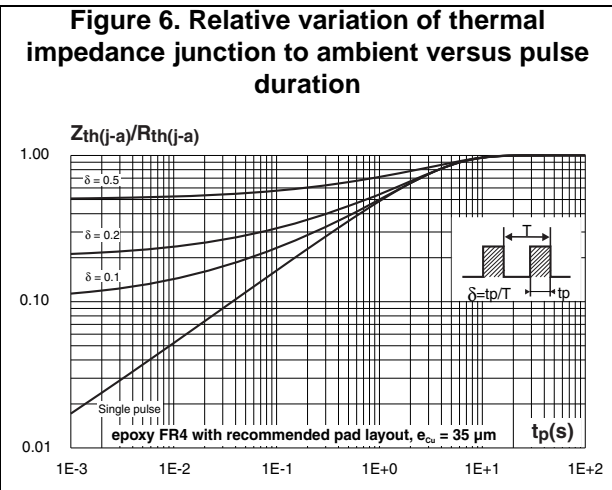
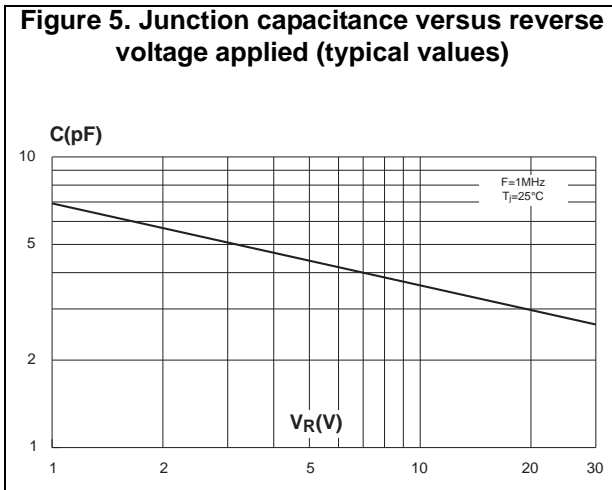
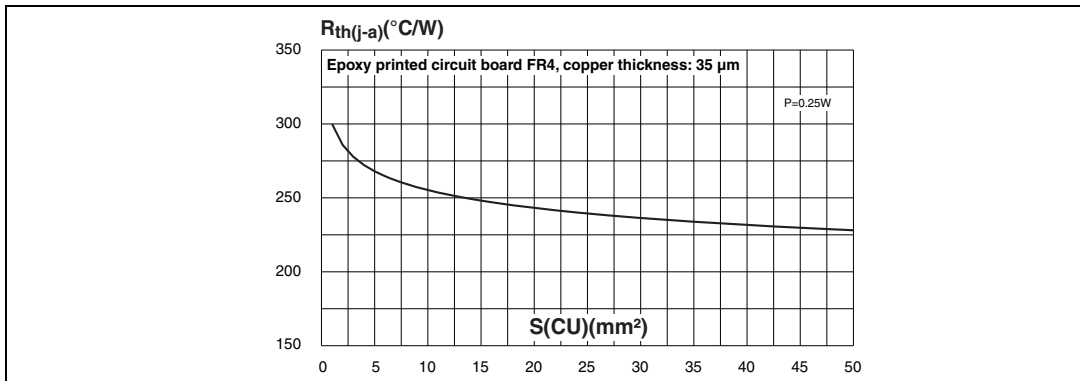

Figure 7. Thermal resistance junction to ambient versus copper surface under each lead



2 Package information

- Epoxy meets UL94, V0
- Lead-free packages

In order to meet environmental requirements, ST offers these devices in different grades of ECOPACK® packages, depending on their level of environmental compliance. ECOPACK® specifications, grade definitions and product status are available at: www.st.com. ECOPACK® is an ST trademark.

Table 6. SOT23-3L dimensions

Ref.	Dimensions			
	Millimeters		Inches	
	Min.	Max.	Min.	Max.
A	0.89	1.4	0.035	0.055
A1	0	0.1	0	0.004
B	0.3	0.51	0.012	0.02
c	0.085	0.18	0.003	0.007
D	2.75	3.04	0.108	0.12
e	0.85	1.05	0.033	0.041
e1	1.7	2.1	0.067	0.083
E	1.2	1.6	0.047	0.063
H	2.1	2.75	0.083	0.108
L	0.6 typ.		0.024 typ.	
S	0.35	0.65	0.014	0.026

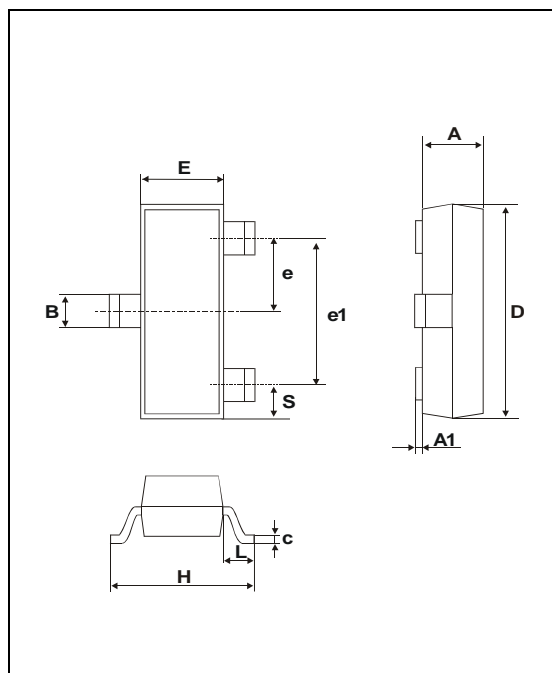
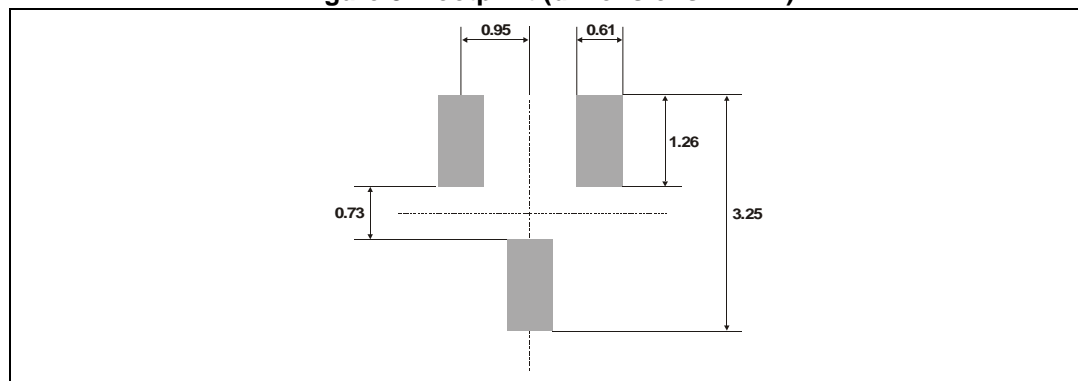

Figure 8. Footprint (dimensions in mm)



3 Ordering information

Table 7. Ordering information

Order code	Marking	Package	Weight	Base Qty	Delivery mode
BAR42FILM	D94	SOT23-3L	0.01 g	3000	Tape and reel
BAR43FILM	D95				
BAR43AFILM	DB1				
BAR43CFILM	DB2				
BAR43SFILM	DA5				

4 Revision history

Table 8. Document revision history

Date	Revision	Changes
Aug-2001	2B	Last release.
16-Apr-2005	3	Layout update. No content change.
23-Apr-2014	4	Updated ECOPACK statement.
18-Jul-2017	5	Updated figure in cover page.

IMPORTANT NOTICE – PLEASE READ CAREFULLY

STMicroelectronics NV and its subsidiaries ("ST") reserve the right to make changes, corrections, enhancements, modifications, and improvements to ST products and/or to this document at any time without notice. Purchasers should obtain the latest relevant information on ST products before placing orders. ST products are sold pursuant to ST's terms and conditions of sale in place at the time of order acknowledgement.

Purchasers are solely responsible for the choice, selection, and use of ST products and ST assumes no liability for application assistance or the design of Purchasers' products.

No license, express or implied, to any intellectual property right is granted by ST herein.

Resale of ST products with provisions different from the information set forth herein shall void any warranty granted by ST for such product.

ST and the ST logo are trademarks of ST. All other product or service names are the property of their respective owners.

Information in this document supersedes and replaces information previously supplied in any prior versions of this document.

© 2017 STMicroelectronics – All rights reserved

Mouser Electronics

Authorized Distributor

Click to View Pricing, Inventory, Delivery & Lifecycle Information:

[STMicroelectronics:](#)

[BAR43AFILM](#) [BAR43SFILM](#) [BAR42FILM](#) [BAR43FILM](#) [BAR43CFILM](#)