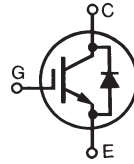
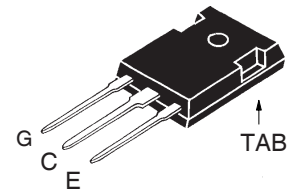

GenX3™ 1200V IGBT
IXGH30N120C3H1
**High speed PT IGBTs for
10-50kHz Switching**

$$\begin{aligned}
 V_{CES} &= 1200V \\
 I_{C100} &= 24A \\
 V_{CE(sat)} &\leq 4.2V \\
 t_{fi(typ)} &= 42ns
 \end{aligned}$$

Symbol	Test Conditions	Maximum Ratings	
V_{CES}	$T_J = 25^\circ\text{C}$ to 150°C	1200	V
V_{CGR}	$T_J = 25^\circ\text{C}$ to 150°C , $R_{GE} = 1M\Omega$	1200	V
V_{GES}	Continuous	± 20	V
V_{GEM}	Transient	± 30	V
I_{C25}	$T_C = 25^\circ\text{C}$	48	A
I_{C100}	$T_C = 100^\circ\text{C}$	24	A
I_{CM}	$T_C = 25^\circ\text{C}$, 1ms	115	A
I_A	$T_C = 25^\circ\text{C}$	20	A
E_{AS}	$T_C = 25^\circ\text{C}$	250	mJ
SSOA (RBSOA)	$V_{GE} = 15V$, $T_J = 125^\circ\text{C}$, $R_G = 5\Omega$ Clamped Inductive Load	$I_{CM} = 60$ @ $V_{CE} \leq 1200$	A V
P_C	$T_C = 25^\circ\text{C}$	250	W
T_J		-55 ... +150	$^\circ\text{C}$
T_{JM}		150	$^\circ\text{C}$
T_{stg}		-55 ... +150	$^\circ\text{C}$
M_d	Mounting Torque	1.13/10	Nm/lb.in.
T_L	Maximum Lead Temperature for Soldering	300	$^\circ\text{C}$
T_{SOLD}	1.6mm (0.062 in.) from Case for 10s	260	$^\circ\text{C}$
Weight		6	g

TO-247AD

G = Gate C = Collector
E = Emitter TAB = Collector

Features

- Optimized for Low Conduction and Switching Losses
- Square RBSOA
- Anti-Parallel Ultra Fast Diode
- Avalanche Rated
- International Standard Package

Advantages

- High Power Density
- Low Gate Drive Requirement

Applications

- AC Motor Speed Control
- DC Servo and Robot Drives
- DC Choppers
- Uninterruptible Power Supplies (UPS)
- Switch-Mode and Resonant-Mode Power Supplies

Symbol	Test Conditions ($T_J = 25^\circ\text{C}$, Unless Otherwise Specified)	Characteristic Values		
		Min.	Typ.	Max.
BV_{CES}	$I_C = 250\mu\text{A}$, $V_{GE} = 0V$	1200		V
$V_{GE(th)}$	$I_C = 250\mu\text{A}$, $V_{CE} = V_{GE}$	3.0		5.0 V
I_{CES}	$V_{CE} = V_{CES}$, $V_{GE} = 0V$ $T_J = 125^\circ\text{C}$			100 μA 1.5 mA
I_{GES}	$V_{CE} = 0V$, $V_{GE} = \pm 20V$			± 100 nA
$V_{CE(sat)}$	$I_C = 24A$, $V_{GE} = 15V$, Note 2 $T_J = 125^\circ\text{C}$		3.6 3.2	4.2 V V

Symbol	Test Conditions ($T_J = 25^\circ\text{C}$, Unless Otherwise Specified)	Characteristic Values		
		Min.	Typ.	Max.
g_{fs}	$I_C = 24\text{A}$, $V_{CE} = 10\text{V}$, Note 2	10	17	S
C_{ies} C_{oes} C_{res}	$V_{CE} = 25\text{V}$, $V_{GE} = 0\text{V}$, $f = 1\text{MHz}$		1810	pF
			185	pF
			50	pF
Q_g Q_{ge} Q_{gc}	$I_C = 24\text{A}$, $V_{GE} = 15\text{V}$, $V_{CE} = 0.5 \cdot V_{CES}$		80	nC
			11	nC
			37	nC
$t_{d(on)}$ t_{ri} E_{on} $t_{d(off)}$ t_{fi} E_{off}	Inductive Load, $T_J = 25^\circ\text{C}$ $I_C = 24\text{A}$, $V_{GE} = 15\text{V}$ $V_{CE} = 600\text{V}$, $R_G = 5\Omega$ Note 1		18	ns
			33	ns
			1.45	mJ
			106	ns
			42	ns
			0.47	mJ
$t_{d(on)}$ t_{ri} E_{on} $t_{d(off)}$ t_{fi} E_{off}	Inductive Load, $T_J = 125^\circ\text{C}$ $I_C = 24\text{A}$, $V_{GE} = 15\text{V}$ $V_{CE} = 600\text{V}$, $R_G = 5\Omega$ Note 1		20	ns
			40	ns
			2.50	mJ
			135	ns
			280	ns
			1.30	mJ
R_{thJC} R_{thCK}				0.50 $^\circ\text{C/W}$ $^\circ\text{C/W}$

TO-247 (IXGH) AD Outline

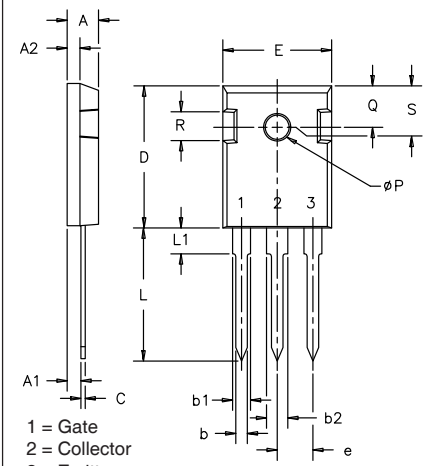

SYM	INCHES		MILLIMETERS	
	MIN	MAX	MIN	MAX
A	.185	.209	4.7	5.3
A1	.087	.102	2.2	2.54
A2	.059	.098	2.2	2.6
b	.040	.055	1.0	1.4
b1	.065	.084	1.65	2.13
b2	.113	.123	2.87	3.12
C	.016	.031	.4	.8
D	.819	.845	20.80	21.46
E	.610	.640	15.75	16.26
e	.215 BSC		5.45 BSC	
L	.780	.800	19.81	20.32
L1		.177		4.50
øP	.140	.144	3.55	3.65
Q	.212	.244	5.4	6.2
R	.170	.216	4.32	5.49
S	.242 BSC		6.15 BSC	

Reverse Diode (FRED)

Symbol	Test Conditions ($T_J = 25^\circ\text{C}$, Unless Otherwise Specified)	Characteristic Values		
		Min.	Typ.	Max.
V_F	$I_F = 20\text{A}$, $V_{GE} = 0\text{V}$ $T_J = 125^\circ\text{C}$			3.0 V 2.8 V
I_{RM} t_{rr}	$I_F = 20\text{A}$, $-di_F/dt = 750\text{A}/\mu\text{s}$, $V_R = 800\text{V}$ $V_{GE} = 0\text{V}$		19	A
			70	ns
R_{thJC}				0.9 $^\circ\text{C/W}$

- Notes:
- Switching Times May Increase for V_{CE} (Clamp) $> 0.5 \cdot V_{CES}$, Higher T_J or Increased R_G .
 - Pulse Test, $t \leq 300\mu\text{s}$; Duty Cycle, $d \leq 2\%$.

PRELIMINARY TECHNICAL INFORMATION

The product presented herein is under development. The Technical Specifications offered are derived from data gathered during objective characterizations of preliminary engineering lots; but also may yet contain some information supplied during a pre-production design evaluation. IXYS reserves the right to change limits, test conditions, and dimensions without notice.

IXYS reserves the right to change limits, test conditions, and dimensions.

IXYS MOSFETs and IGBTs are covered by one or more of the following U.S. patents:	4,835,592	4,931,844	5,049,961	5,237,481	6,162,665	6,404,065 B1	6,683,344	6,727,585	7,005,734 B2	7,157,338B2
	4,850,072	5,017,508	5,063,307	5,381,025	6,259,123 B1	6,534,343	6,710,405 B2	6,759,692	7,063,975 B2	
	4,881,106	5,034,796	5,187,117	5,486,715	6,306,728 B1	6,583,505	6,710,463	6,771,478 B2	7,071,537	

Fig. 1. Output Characteristics @ 25°C

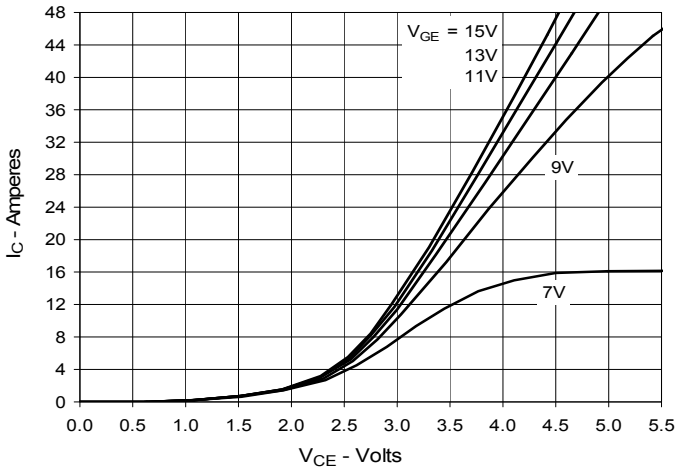

Fig. 2. Extended Output Characteristics @ 25°C

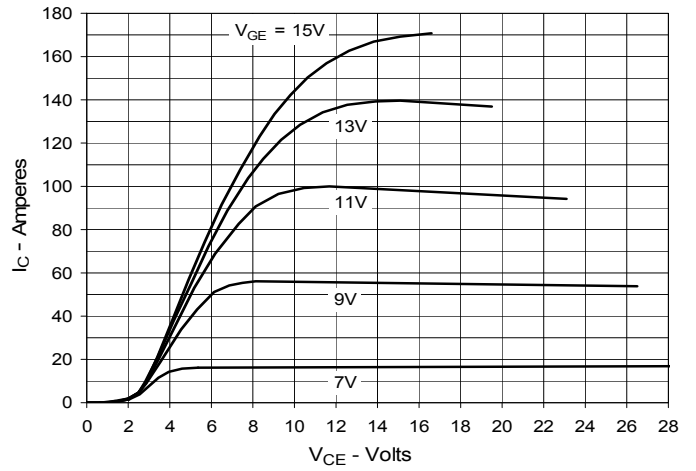

Fig. 3. Output Characteristics @ 125°C

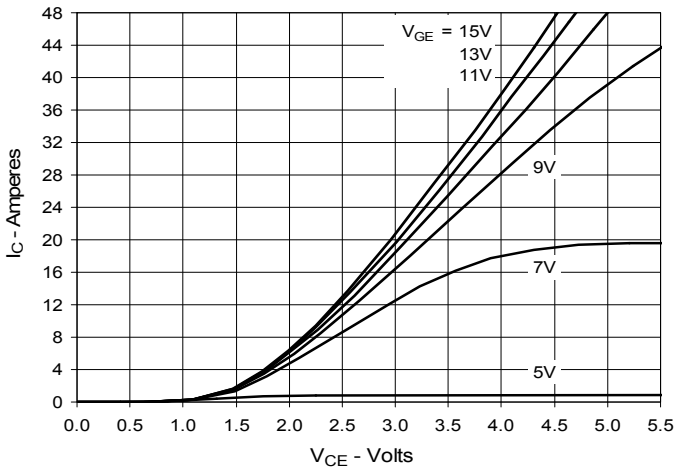

Fig. 4. Dependence of $V_{CE(sat)}$ on Junction Temperature

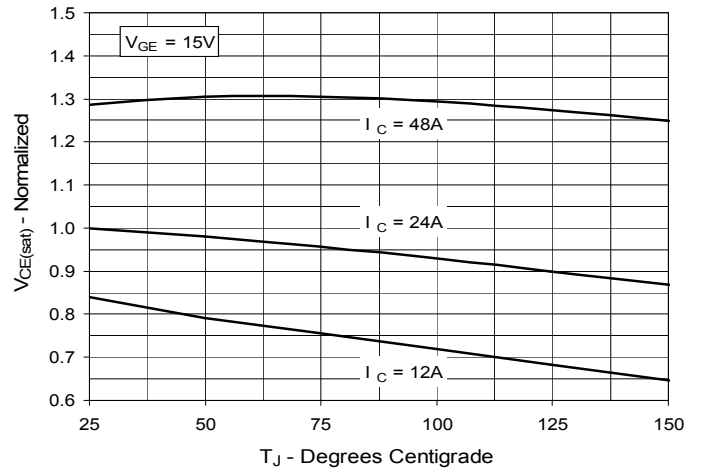

Fig. 5. Collector-to-Emitter Voltage vs. Gate-to-Emitter Voltage

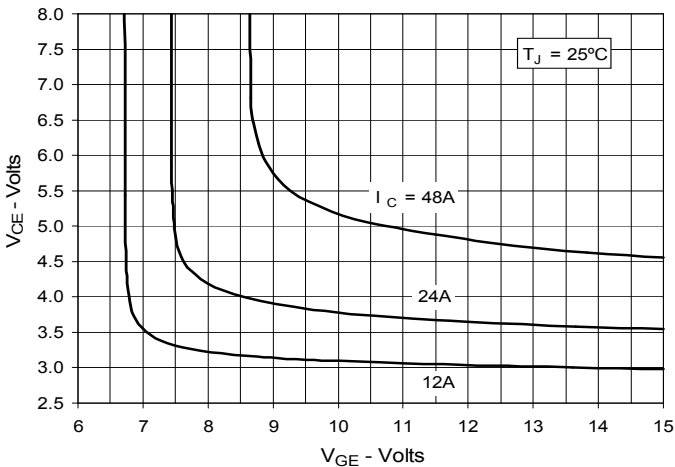

Fig. 6. Input Admittance

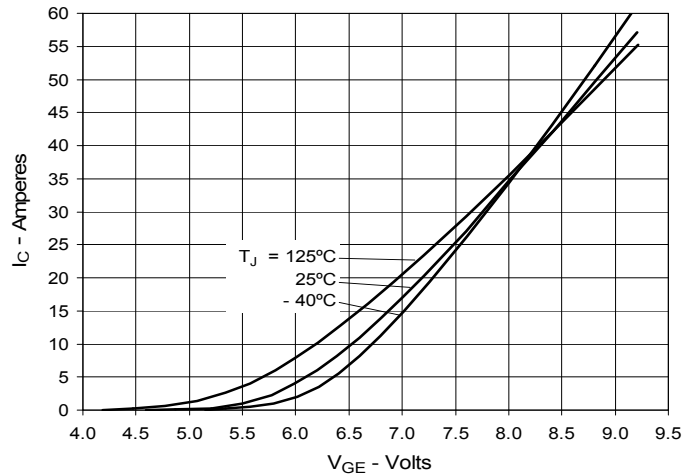

Fig. 7. Transconductance

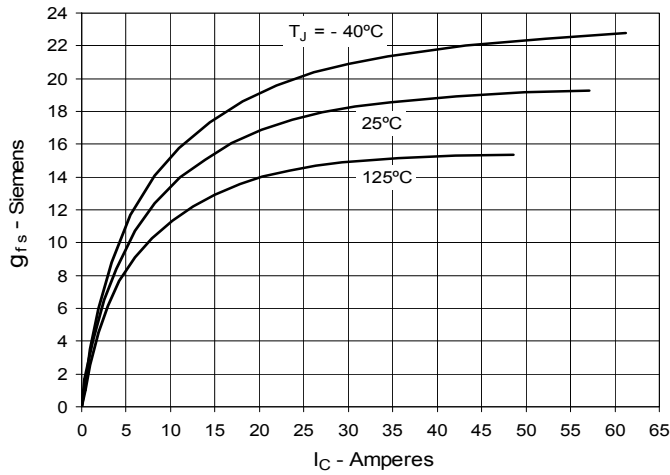

Fig. 8. Gate Charge

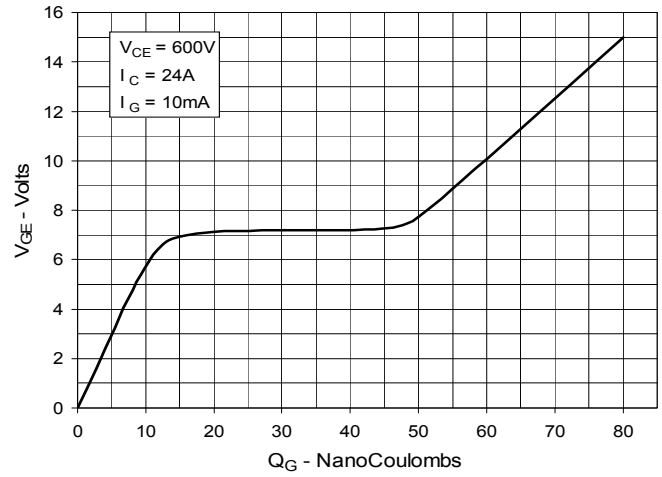

Fig. 9. Capacitance

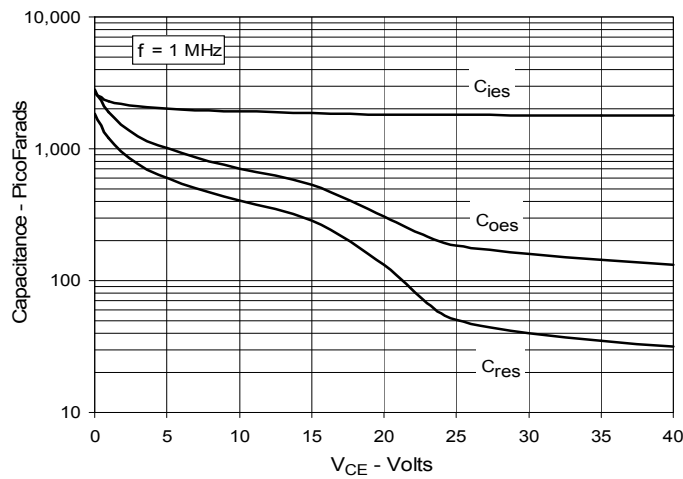

Fig. 10. Reverse-Bias Safe Operating Area

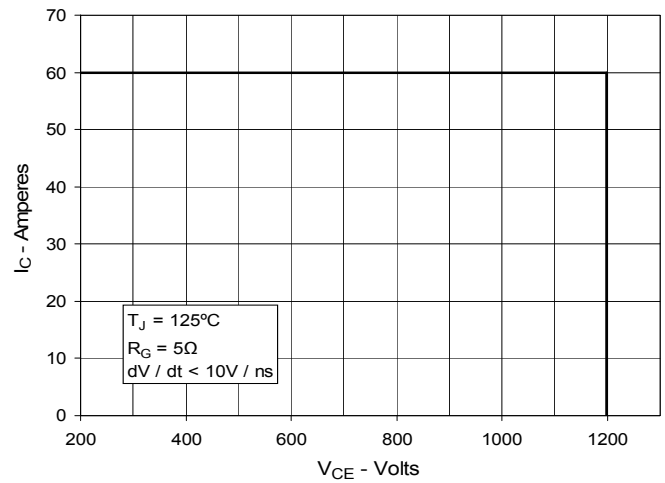
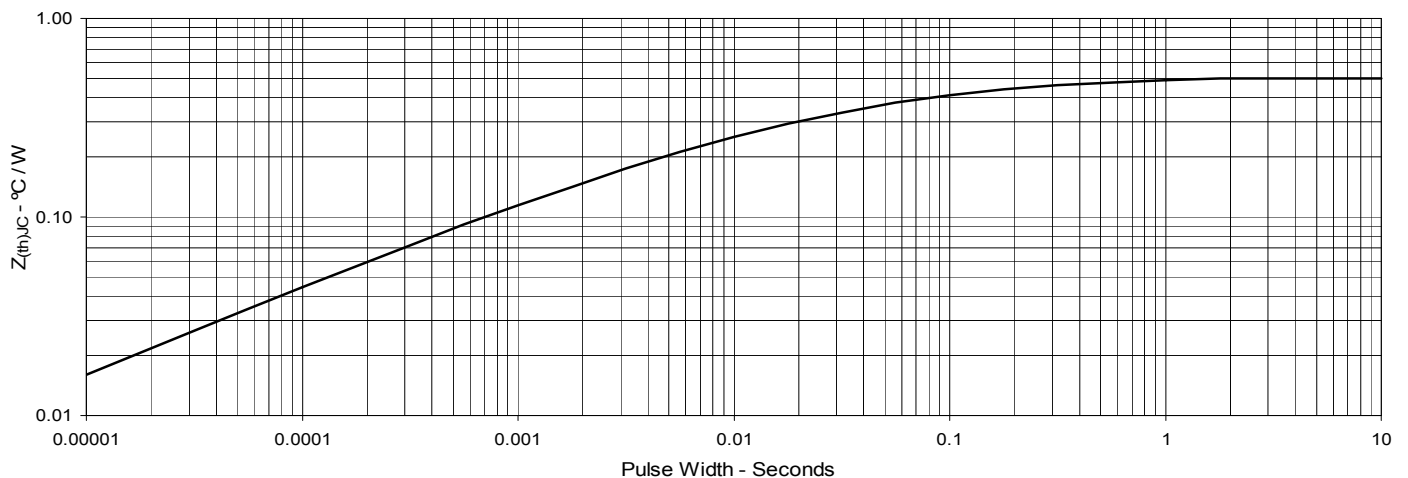

Fig. 11. Maximum Transient Thermal Impedance



IXYS reserves the right to change limits, test conditions, and dimensions.

**Fig. 12. Inductive Switching
Energy Loss vs. Gate Resistance**

**Fig. 13. Inductive Switching
Energy Loss vs. Collector Current**

**Fig. 14. Inductive Switching
Energy Loss vs. Junction Temperature**

**Fig. 15. Inductive Turn-off
Switching Times vs. Gate Resistance**

**Fig. 16. Inductive Turn-off
Switching Times vs. Collector Current**

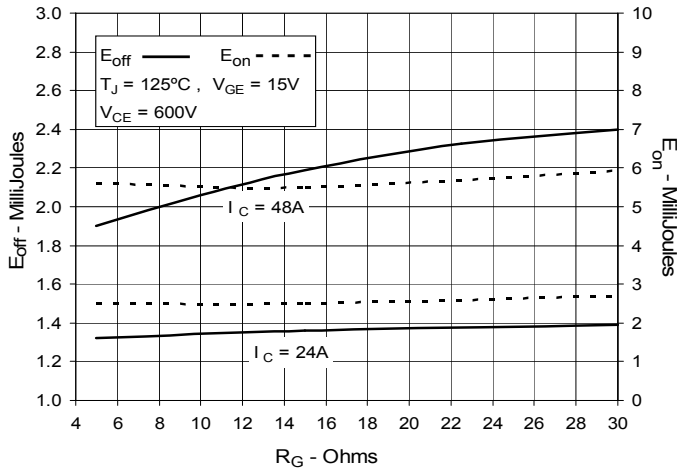
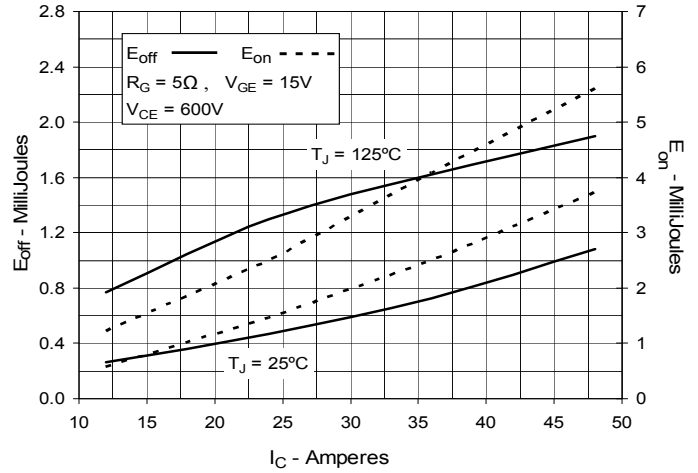
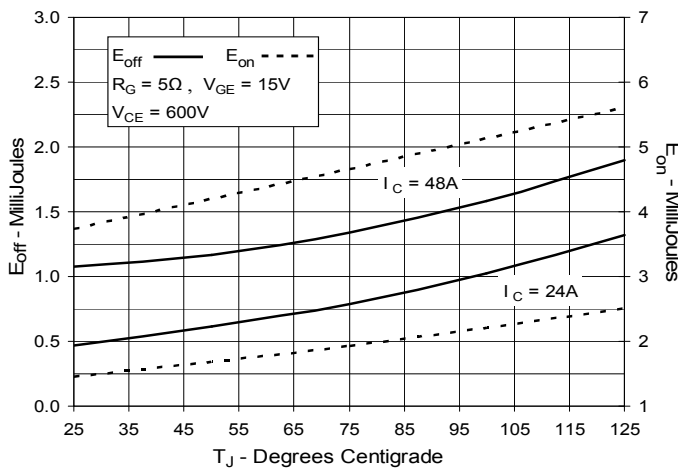
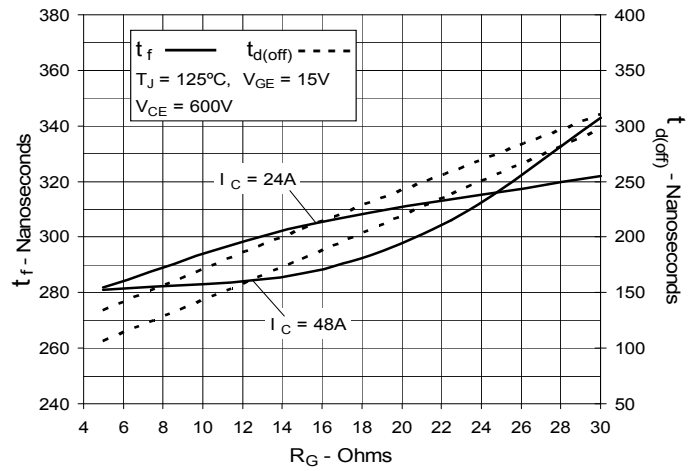
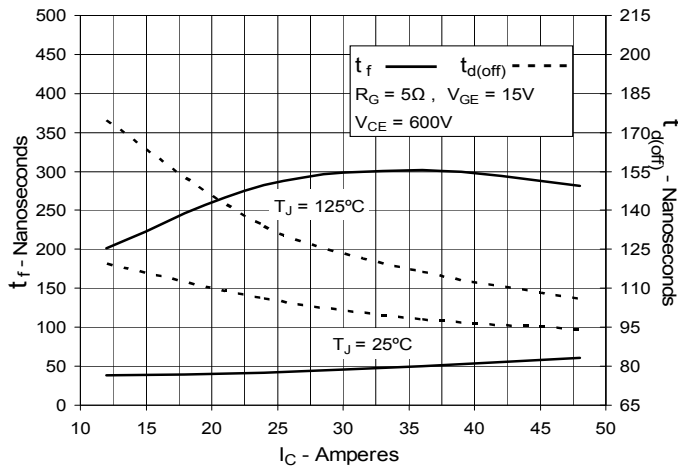
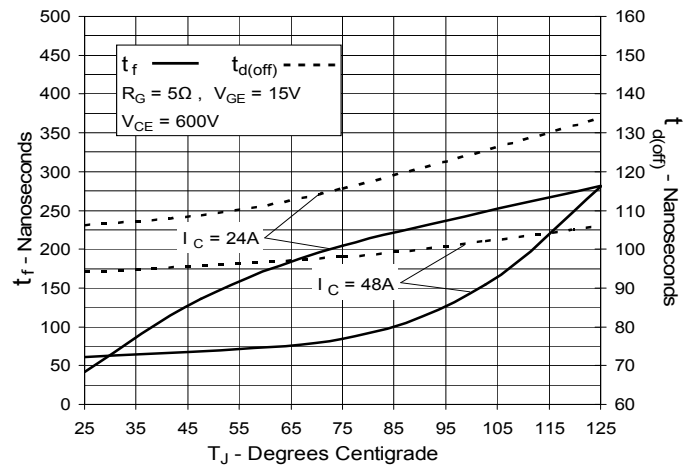
**Fig. 17. Inductive Turn-off
Switching Times vs. Junction Temperature**

Fig. 18. Inductive Turn-on Switching Times vs. Gate Resistance

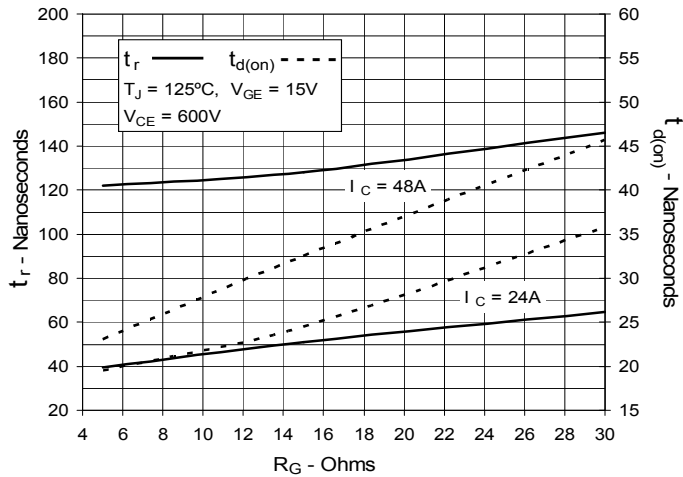

Fig. 19. Inductive Turn-on Switching Times vs. Collector Current

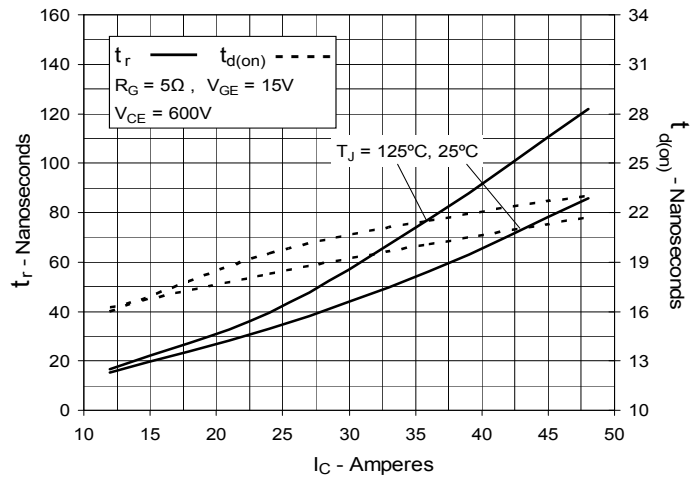
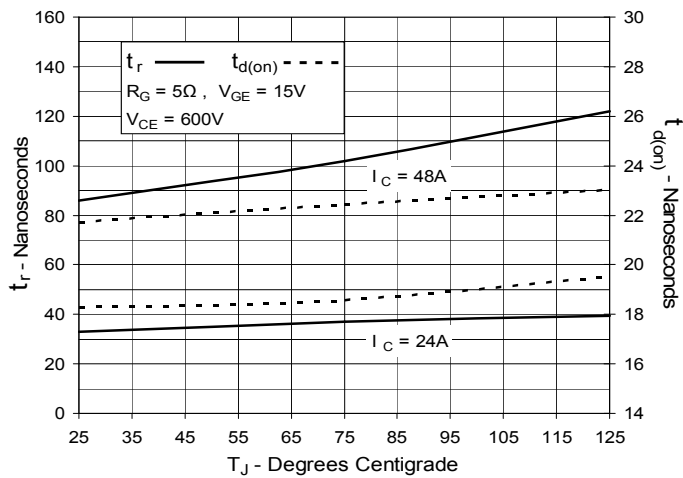

Fig. 20. Inductive Turn-on Switching Times vs. Junction Temperature



Mouser Electronics

Authorized Distributor

Click to View Pricing, Inventory, Delivery & Lifecycle Information:

[IXYS:](#)

[IXGH30N120C3H1](#)