

Part Number: PDC54-12EWA

HIGH EFFICIENCY RED

Features

- 0.54 INCH CHARACTER HEIGHT.
- LOW CURRENT OPERATION.
- HIGH CONTRAST AND LIGHT OUTPUT.
- EASY MOUNTING ON P.C. BOARDS OR SOCKETS.
- CATEGORIZED FOR LUMINOUS INTENSITY.
- MECHANICALLY RUGGED.
- STANDARD: GRAY FACE, WHITE SEGMENT.
- RoHS COMPLIANT.

Description

The High Efficiency Red source color devices are made with Gallium Arsenide Phosphide on Gallium Phosphide Orange Light Emitting Diode.

Package Dimensions & Internal Circuit Diagram

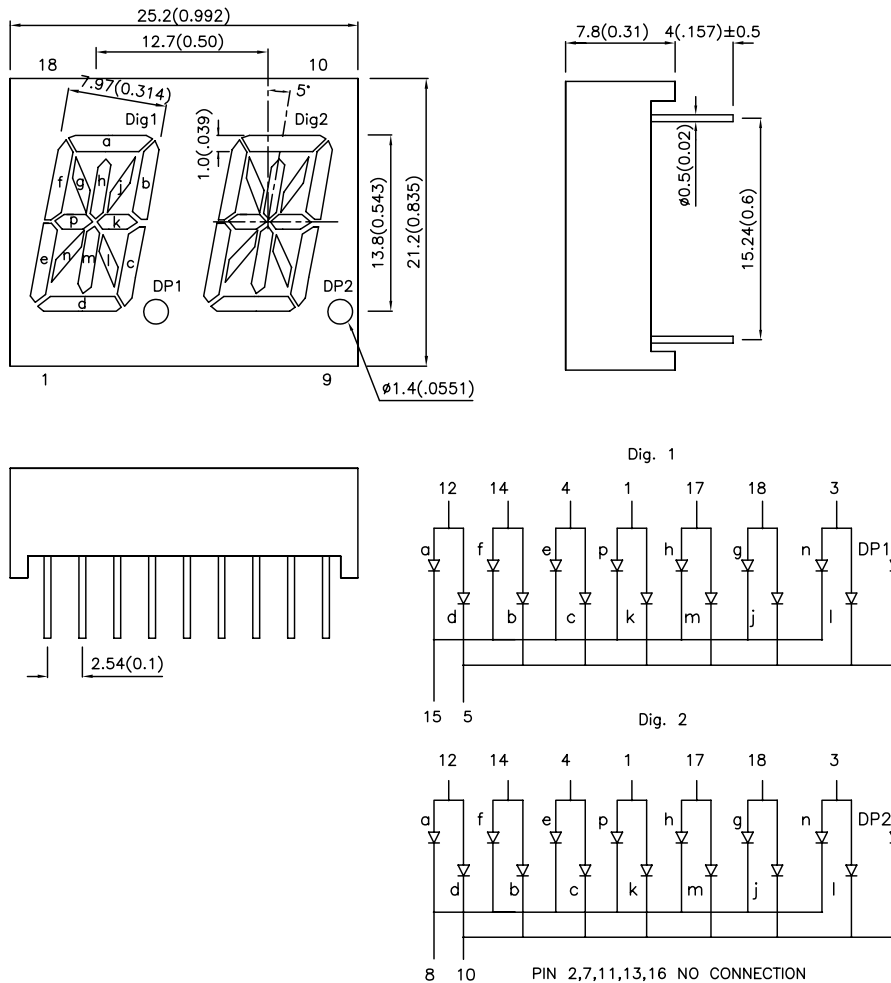

Selection Guide

Part No.	Dice	Lens Type	Iv (ucd) [1] @ 10mA		Description
			Min.	Typ.	
PDC54-12EWA	HIGH EFFICIENCY RED (GaAsP/GaP)	WHITE DIFFUSED	1200	4700	Common Cathode, Rt. Hand Decimal

Note:

1. Luminous Intensity/ Luminous Flux: +/-15%.

Electrical / Optical Characteristics at TA=25°C

Symbol	Parameter	Device	Typ.	Max.	Units	Test Conditions
λ_{peak}	Peak Wavelength	High Efficiency Red	627		nm	IF=20mA
λ_D [1]	Dominant Wavelength	High Efficiency Red	625		nm	IF=20mA
$\Delta\lambda_{1/2}$	Spectral Line Half-width	High Efficiency Red	45		nm	IF=20mA
C	Capacitance	High Efficiency Red	15		pF	VF=0V;f=1MHz
VF [2]	Forward Voltage Per Segment or DP	High Efficiency Red	2.0	2.5	V	IF=20mA
IR	Reverse Current Per Segment or DP	High Efficiency Red		10	uA	VR = 5V

Notes:

1. Wavelength: +/-1nm.

2. Forward Voltage: +/-0.1V.

Absolute Maximum Ratings at TA=25°C

Parameter	High Efficiency Red	Units
Power dissipation Per Segment or DP	150	mW
DC Forward Current Per Segment or DP	30	mA
Peak Forward Current [1] Per Segment or DP	160	mA
Reverse Voltage Per Segment or DP	5	V
Operating/Storage Temperature	-40°C To +85°C	
Lead Solder Temperature [2]	260°C For 3 Seconds	

Notes:

1. 1/10 Duty Cycle, 0.1ms Pulse Width.

2. 2mm below package base.

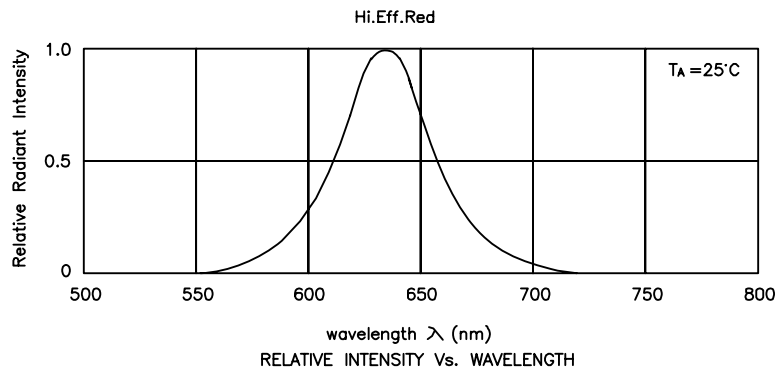

High Efficiency Red

PDC54-12EWA

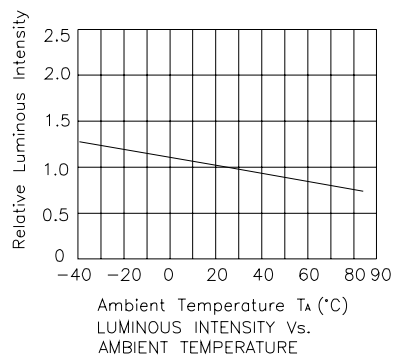
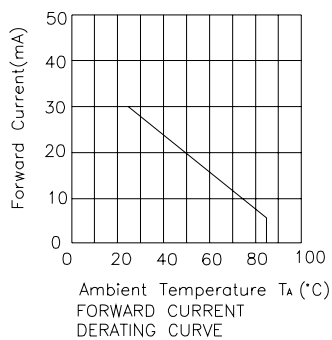
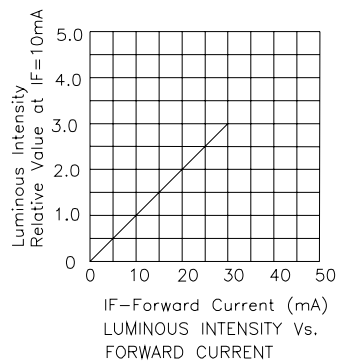
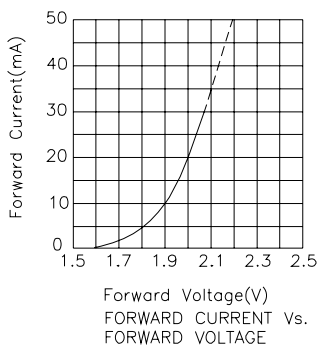

PACKING & LABEL SPECIFICATIONS

PDC54-12EWA

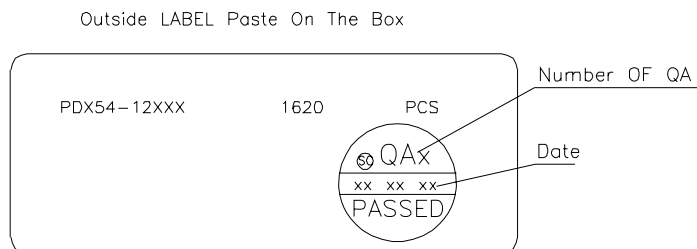
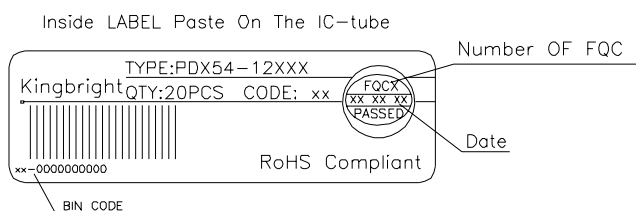
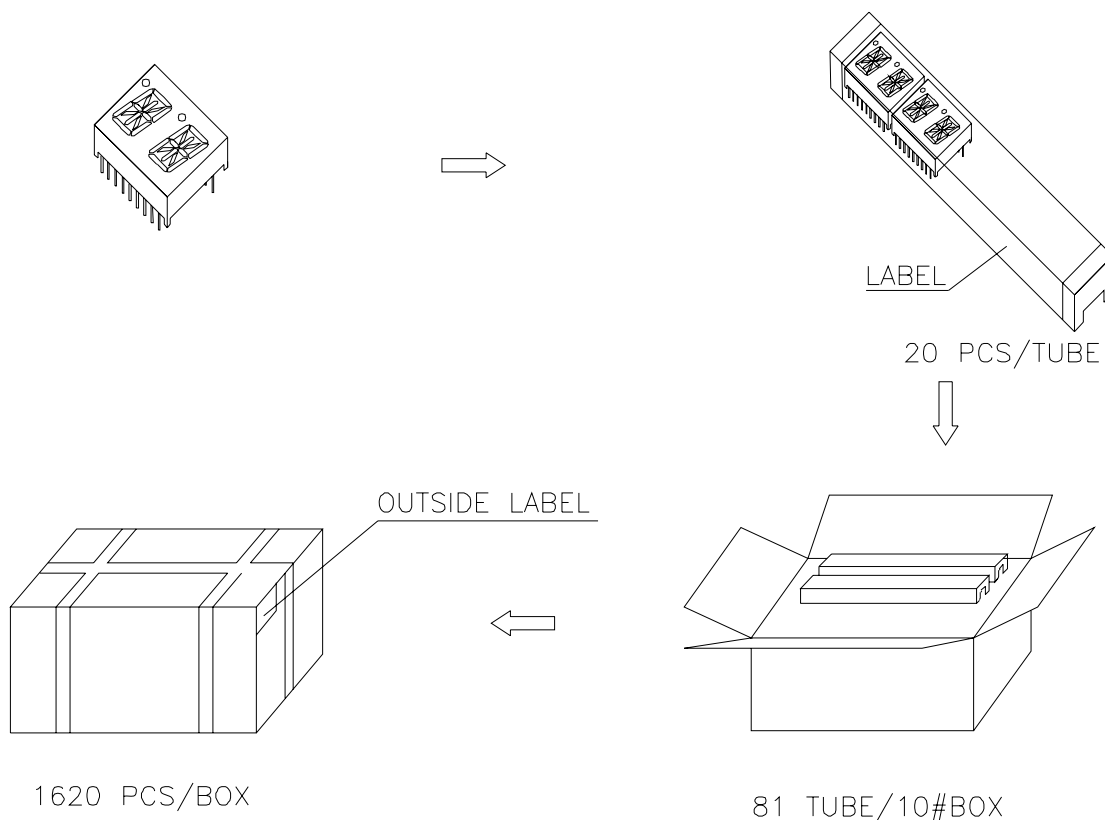

Mouser Electronics

Authorized Distributor

Click to View Pricing, Inventory, Delivery & Lifecycle Information:

[Kingbright:](#)

[PDC54-12EWA](#)