

74LV132-Q100

Quad 2-input NAND Schmitt trigger

Rev. 1 — 11 November 2013

Product data sheet

1. General description

The 74LV132-Q100 is a low-voltage Si-gate CMOS device that is pin and function compatible with 74HC132-Q100 and 74HCT132-Q100.

The 74LV132-Q100 contains four 2-input NAND gates which accept standard input signals. These gates are capable of transforming slowly changing input signals into sharply defined, jitter-free output signals.

The gate switches at different points for positive and negative-going signals. The difference between the positive voltage V_{T+} and the negative voltage V_{T-} is defined as the input hysteresis voltage V_H .

This product has been qualified to the Automotive Electronics Council (AEC) standard Q100 (Grade 1) and is suitable for use in automotive applications.

2. Features and benefits

- Automotive product qualification in accordance with AEC-Q100 (Grade 1)
 - ◆ Specified from $-40\text{ }^{\circ}\text{C}$ to $+85\text{ }^{\circ}\text{C}$ and from $-40\text{ }^{\circ}\text{C}$ to $+125\text{ }^{\circ}\text{C}$
- Wide operating voltage: 1.0 V to 5.5 V
- Optimized for low voltage applications: 1.0 V to 3.6 V
- Accepts TTL input levels between $V_{CC} = 2.7\text{ V}$ and $V_{CC} = 3.6\text{ V}$
- Typical output ground bounce $< 0.8\text{ V}$ at $V_{CC} = 3.3\text{ V}$ and $T_{amb} = 25\text{ }^{\circ}\text{C}$
- Typical HIGH-level output voltage (V_{OH}) undershoot: $> 2\text{ V}$ at $V_{CC} = 3.3\text{ V}$ and $T_{amb} = 25\text{ }^{\circ}\text{C}$
- ESD protection:
 - ◆ MIL-STD-883, method 3015 exceeds 2000 V
 - ◆ HBM JESD22-A114F exceeds 2000 V
 - ◆ MM JESD22-A115-A exceeds 200 V ($C = 200\text{ pF}$, $R = 0\text{ }\Omega$)
- Multiple package options

3. Applications

- Wave and pulse shapers for highly noisy environments
- Astable multivibrators
- Monostable multivibrators

4. Ordering information

Table 1. Ordering information

Type number	Package			Version
	Temperature range	Name	Description	
74LV132D-Q100	-40 °C to +125 °C	SO14	plastic small outline package; 14 leads; body width 3.9 mm	SOT108-1
74LV132PW-Q100	-40 °C to +125 °C	TSSOP14	plastic thin shrink small outline package; 14 leads; body width 4.4 mm	SOT402-1
74LV132BQ-Q100	-40 °C to +125 °C	DHVQFN14	plastic dual in-line compatible thermal enhanced very thin quad flat package; no leads; 14 terminals; body 2.5 × 3 × 0.85 mm	SOT762-1

5. Functional diagram

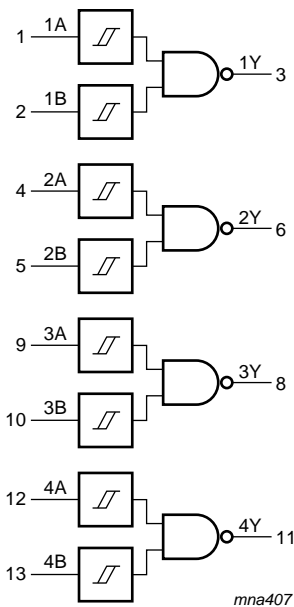

Fig 1. Logic symbol

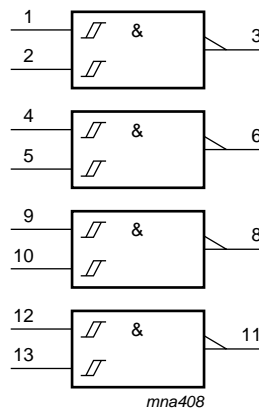

Fig 2. IEC logic symbol

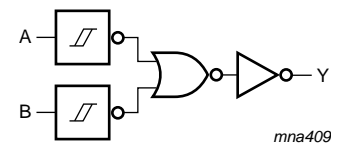
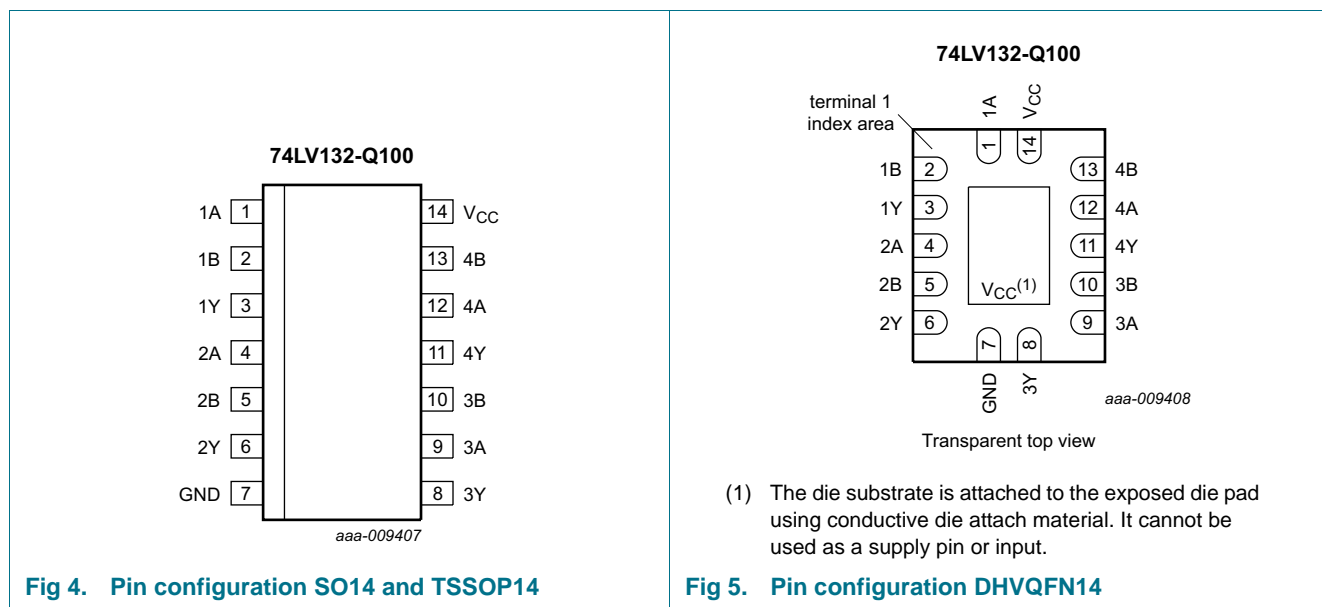

Fig 3. Logic diagram (one gate)

6. Pinning information

6.1 Pinning



6.2 Pin description

Table 2. Pin description

Symbol	Pin	Description
1A	1	data input
1B	2	data input
1Y	3	data output
2A	4	data input
2B	5	data input
2Y	6	data output
GND	7	ground (0 V)
3Y	8	data output
3A	9	data input
3B	10	data input
4Y	11	data output
4A	12	data input
4B	13	data input
V _{CC}	14	supply voltage

7. Functional description

Table 3. Function table

H = HIGH voltage level; L = LOW voltage level.

Input		Output
nA	nB	nY
L	L	H
L	H	H
H	L	H
H	H	L

8. Limiting values

Table 4. Limiting values

In accordance with the Absolute Maximum Rating System (IEC 60134). Voltages are referenced to GND (ground = 0 V).

Symbol	Parameter	Conditions	Min	Max	Unit
V_{CC}	supply voltage		-0.5	+7.0	V
I_{IK}	input clamping current	$V_I < -0.5 \text{ V}$ or $V_I > V_{CC} + 0.5 \text{ V}$	[1] -	± 20	mA
I_{OK}	output clamping current	$V_O < -0.5 \text{ V}$ or $V_O > V_{CC} + 0.5 \text{ V}$	[1] -	± 50	mA
I_O	output current	$V_O = -0.5 \text{ V}$ to $(V_{CC} + 0.5 \text{ V})$	-	± 25	mA
I_{CC}	supply current		-	50	mA
I_{GND}	ground current		-50	-	mA
T_{stg}	storage temperature		-65	+150	°C
P_{tot}	total power dissipation	$T_{amb} = -40 \text{ °C}$ to $+125 \text{ °C}$			
	SO14 package		[2] -	500	mW
	TSSOP14 package		[3] -	500	mW
	DHVQFN14 package		[4] -	500	mW

[1] The input and output voltage ratings may be exceeded if the input and output current ratings are observed.

[2] P_{tot} derates linearly with 8 mW/K above 70 °C.

[3] P_{tot} derates linearly with 5.5 mW/K above 60 °C.

[4] P_{tot} derates linearly with 4.5 mW/K above 60 °C.

9. Recommended operating conditions

Table 5. Recommended operating conditions

Voltages are referenced to GND (ground = 0 V).

Symbol	Parameter	Conditions	Min	Typ	Max	Unit
V_{CC}	supply voltage	[1]	1.0	3.3	5.5	V
V_I	input voltage		0	-	V_{CC}	V
V_O	output voltage		0	-	V_{CC}	V
T_{amb}	ambient temperature		-40	+25	+125	°C

[1] The static characteristics are guaranteed from $V_{CC} = 1.2$ V to $V_{CC} = 5.5$ V. LV devices are guaranteed to function down to $V_{CC} = 1.0$ V (with input levels GND or V_{CC}).

10. Static characteristics

Table 6. Static characteristics

Voltages are referenced to GND (ground = 0 V).

Symbol	Parameter	Conditions	-40 °C to +85 °C			-40 °C to +125 °C		Unit
			Min	Typ [1]	Max	Min	Max	
V_{OH}	HIGH-level output voltage	$V_I = V_{T+}$ or V_{T-}						
		$I_O = -100 \mu\text{A}; V_{CC} = 1.2$ V	-	1.2	-	-	-	V
		$I_O = -100 \mu\text{A}; V_{CC} = 2.0$ V	1.8	2.0	-	1.8	-	V
		$I_O = -100 \mu\text{A}; V_{CC} = 2.7$ V	2.5	2.7	-	2.5	-	V
		$I_O = -100 \mu\text{A}; V_{CC} = 3.0$ V	2.8	3.0	-	2.8	-	V
		$I_O = -100 \mu\text{A}; V_{CC} = 4.5$ V	4.3	4.5	-	4.3	-	V
		$I_O = -6$ mA; $V_{CC} = 3.0$ V	2.4	2.82	-	2.2	-	V
	$I_O = -12$ mA; $V_{CC} = 4.5$ V	3.6	4.2	-	3.5	-	V	
V_{OL}	LOW-level output voltage	$V_I = V_{T+}$ or V_{T-}						
		$I_O = 100 \mu\text{A}; V_{CC} = 1.2$ V	-	0	-	-	-	V
		$I_O = 100 \mu\text{A}; V_{CC} = 2.0$ V	-	0	0.2	-	0.2	V
		$I_O = 100 \mu\text{A}; V_{CC} = 2.7$ V	-	0	0.2	-	0.2	V
		$I_O = 100 \mu\text{A}; V_{CC} = 3.0$ V	-	0	0.2	-	0.2	V
		$I_O = 100 \mu\text{A}; V_{CC} = 4.5$ V	-	0	0.2	-	0.2	V
		$I_O = 6$ mA; $V_{CC} = 3.0$ V	-	0.25	0.40	-	0.50	V
	$I_O = 12$ mA; $V_{CC} = 4.5$ V	-	0.35	0.55	-	0.65	V	
I_I	input leakage current	$V_I = V_{CC}$ or GND; $V_{CC} = 5.5$ V	-	-	1.0	-	1.0	μA
I_{CC}	supply current	$V_I = V_{CC}$ or GND; $I_O = 0$ A; $V_{CC} = 5.5$ V	-	-	20.0	-	40	μA
ΔI_{CC}	additional supply current	per input; $V_I = V_{CC} - 0.6$ V; $V_{CC} = 2.7$ V to 3.6 V	-	-	500	-	850	μA
C_I	input capacitance		-	3.5	-	-	-	pF

[1] Typical values are measured at $T_{amb} = 25$ °C.

11. Dynamic characteristics

Table 7. Dynamic characteristics
GND = 0 V; for test circuit, see Figure 7.

Symbol	Parameter	Conditions	-40 °C to +85 °C			-40 °C to +125 °C		Unit
			Min	Typ ^[1]	Max	Min	Max	
t _{pd}	propagation delay	nA, nB to nY; see Figure 6 ^[2]						
		V _{CC} = 1.2 V	-	65	-	-	-	ns
		V _{CC} = 2.0 V	-	18	34	-	43	ns
		V _{CC} = 2.7 V	-	15	24	-	30	ns
		V _{CC} = 3.0 V to 3.6 V; C _L = 15 pF ^[3]	-	10	-	-	-	ns
		V _{CC} = 3.0 V to 3.6 V ^[3]	-	12	20	-	25	ns
C _{PD}	power dissipation capacitance	C _L = 50 pF; f _i = 1 MHz; ^[4]	-	24	-	-	-	pF
		V _I = GND to V _{CC}						

- [1] All typical values are measured at T_{amb} = 25 °C.
- [2] t_{pd} is the same as t_{PLH} and t_{PHL}.
- [3] Typical values are measured at nominal supply voltage (V_{CC} = 3.3 V and V_{CC} = 5.0 V).
- [4] C_{PD} is used to determine the dynamic power dissipation (P_D in μW).
 $P_D = C_{PD} \times V_{CC}^2 \times f_i \times N + \sum(C_L \times V_{CC}^2 \times f_o)$ where:
 f_i = input frequency in MHz, f_o = output frequency in MHz
 C_L = output load capacitance in pF
 V_{CC} = supply voltage in V
 N = number of inputs switching
 $\sum(C_L \times V_{CC}^2 \times f_o)$ = sum of the outputs.

12. Waveforms

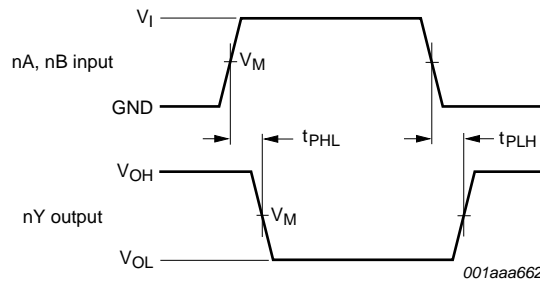

Measurement points are given in [Table 8](#).
 V_{OL} and V_{OH} are typical voltage output levels that occur with the output load.

Fig 6. The input (nA, nB) to output (nY) propagation delays

Table 8. Measurement points

Supply voltage V_{CC}	Input V_M	Output V_M
< 2.7 V	$0.5V_{CC}$	$0.5V_{CC}$
2.7 V to 3.6 V	1.5 V	1.5 V
≥ 4.5 V	$0.5V_{CC}$	$0.5V_{CC}$

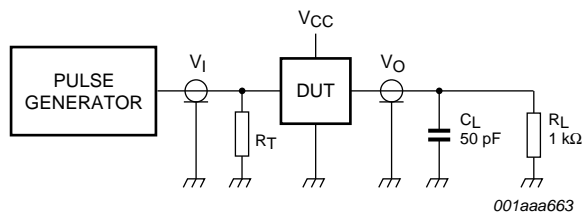

Test data is given in [Table 9](#).

Definitions test circuit:

R_T = Termination resistance should be equal to output impedance Z_o of the pulse generator.

R_L = Load resistance.

C_L = Load capacitance including jig and probe capacitance.

Fig 7. Load circuit for switching times

Table 9. Test data

Supply voltage V_{CC}	Input V_I	t_r, t_f
< 2.7 V	V_{CC}	≤ 2.5 ns
2.7 V to 3.6 V	2.7 V	≤ 2.5 ns
≥ 4.5 V	V_{CC}	≤ 2.5 ns

13. Transfer characteristics

Table 10. Transfer characteristics

$GND = 0$ V; for test circuit, see [Figure 7](#).

Symbol	Parameter	Conditions	-40 °C to +85 °C			-40 °C to +125 °C		Unit
			Min	Typ ^[1]	Max	Min	Max	
V_{T+}	positive-going threshold voltage	see Figure 6						
		$V_{CC} = 1.2$ V	-	0.70	-	-	-	V
		$V_{CC} = 2.0$ V	0.8	1.10	1.4	0.8	1.4	V
		$V_{CC} = 2.7$ V	1.0	1.45	2.0	1.0	2.0	V
		$V_{CC} = 3.0$ V	1.2	1.60	2.2	1.2	2.2	V
		$V_{CC} = 3.6$ V	1.5	1.95	2.4	1.5	2.4	V
		$V_{CC} = 4.5$ V	1.7	2.50	3.2	1.7	3.2	V
	$V_{CC} = 5.5$ V	2.1	3.00	3.9	2.1	3.9	V	

Table 10. Transfer characteristics ...continued
GND = 0 V; for test circuit, see Figure 7.

Symbol	Parameter	Conditions	-40 °C to +85 °C			-40 °C to +125 °C		Unit
			Min	Typ ^[1]	Max	Min	Max	
V_{T-}	negative-going threshold voltage	see Figure 6						
		$V_{CC} = 1.2 \text{ V}$	-	0.34	-	-	-	V
		$V_{CC} = 2.0 \text{ V}$	0.3	0.65	0.9	0.3	0.9	V
		$V_{CC} = 2.7 \text{ V}$	0.4	0.90	1.4	0.4	1.4	V
		$V_{CC} = 3.0 \text{ V}$	0.6	1.05	1.5	0.6	1.5	V
		$V_{CC} = 3.6 \text{ V}$	0.8	1.30	1.8	0.8	1.8	V
		$V_{CC} = 4.5 \text{ V}$	0.9	1.60	2.0	0.9	2.0	V
V_H	hysteresis voltage ($V_{T+} - V_{T-}$); see Figure 6	$V_{CC} = 1.2 \text{ V}$	-	0.3	-	-	-	V
		$V_{CC} = 2.0 \text{ V}$	0.2	0.55	0.8	0.2	0.8	V
		$V_{CC} = 2.7 \text{ V}$	0.3	0.60	1.1	0.3	1.1	V
		$V_{CC} = 3.0 \text{ V}$	0.4	0.65	1.2	0.4	1.2	V
		$V_{CC} = 3.6 \text{ V}$	0.4	0.70	1.2	0.4	1.2	V
		$V_{CC} = 4.5 \text{ V}$	0.4	0.80	1.4	0.4	1.4	V
		$V_{CC} = 5.5 \text{ V}$	0.6	1.00	1.5	0.6	1.5	V

[1] All typical values are measured at $T_{amb} = 25 \text{ °C}$.

14. Waveforms transfer characteristics

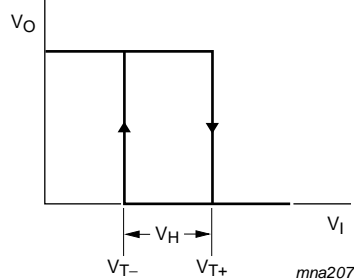
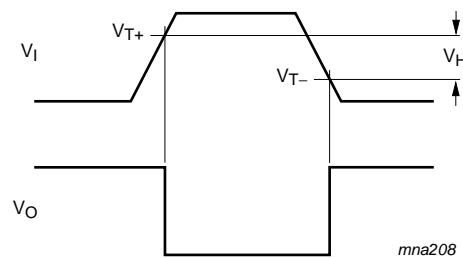
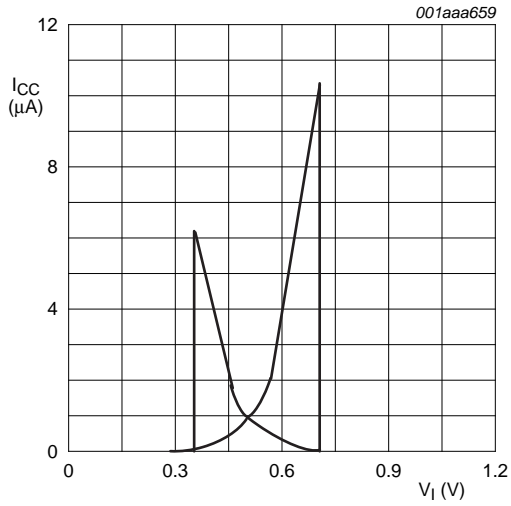

Fig 8. Transfer characteristic



V_{T+} and V_{T-} limits at 70 % and 20 %.

Fig 9. Definition of V_{T+} , V_{T-} and V_H



$V_{CC} = 1.2 \text{ V.}$

Fig 10. Typical 74LV132-Q100 transfer characteristics

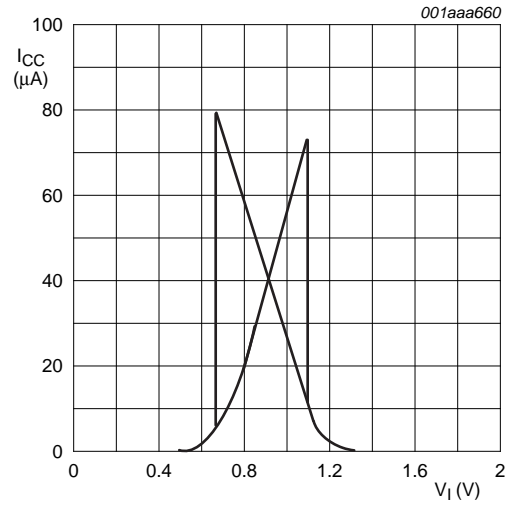

$V_{CC} = 2.0 \text{ V.}$

Fig 11. Typical 74LV132-Q100 transfer characteristics

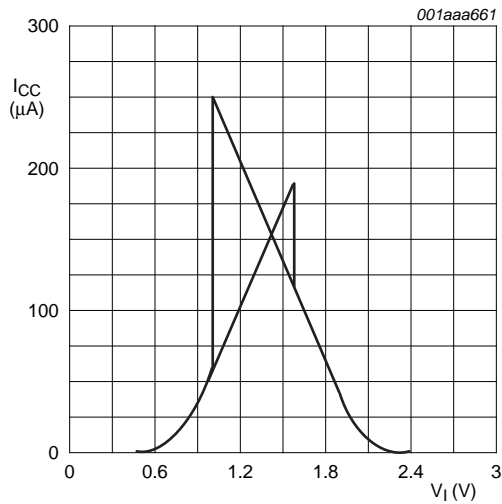

$V_{CC} = 3.0 \text{ V.}$

Fig 12. Typical 74LV132-Q100 transfer characteristics

15. Package outline

SO14: plastic small outline package; 14 leads; body width 3.9 mm

SOT108-1

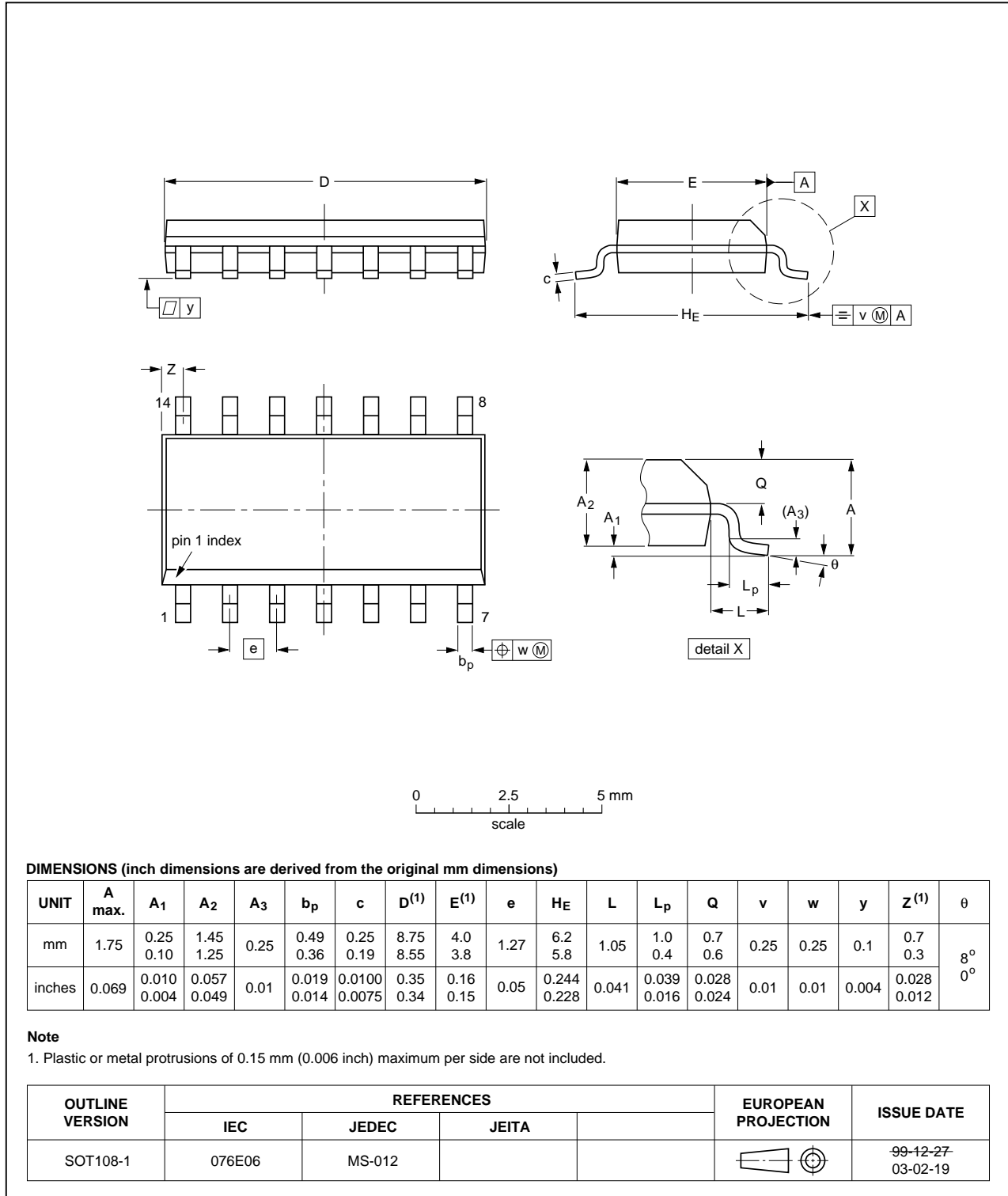

Fig 13. Package outline SOT108-1 (SO14)

TSSOP14: plastic thin shrink small outline package; 14 leads; body width 4.4 mm

SOT402-1

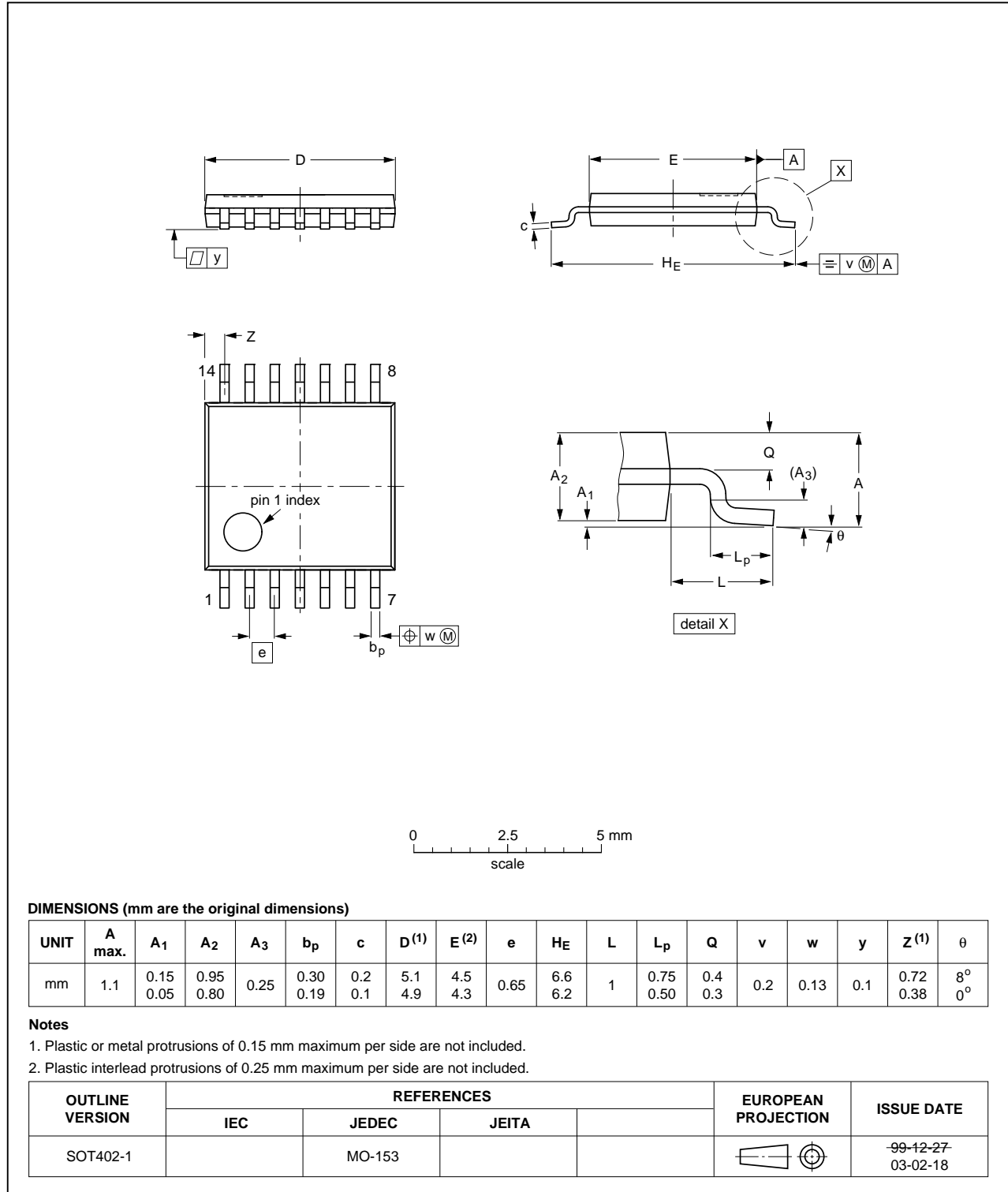

Fig 14. Package outline SOT402-1 (TSSOP14)

DHVQFN14: plastic dual in-line compatible thermal enhanced very thin quad flat package; no leads; 14 terminals; body 2.5 x 3 x 0.85 mm

SOT762-1

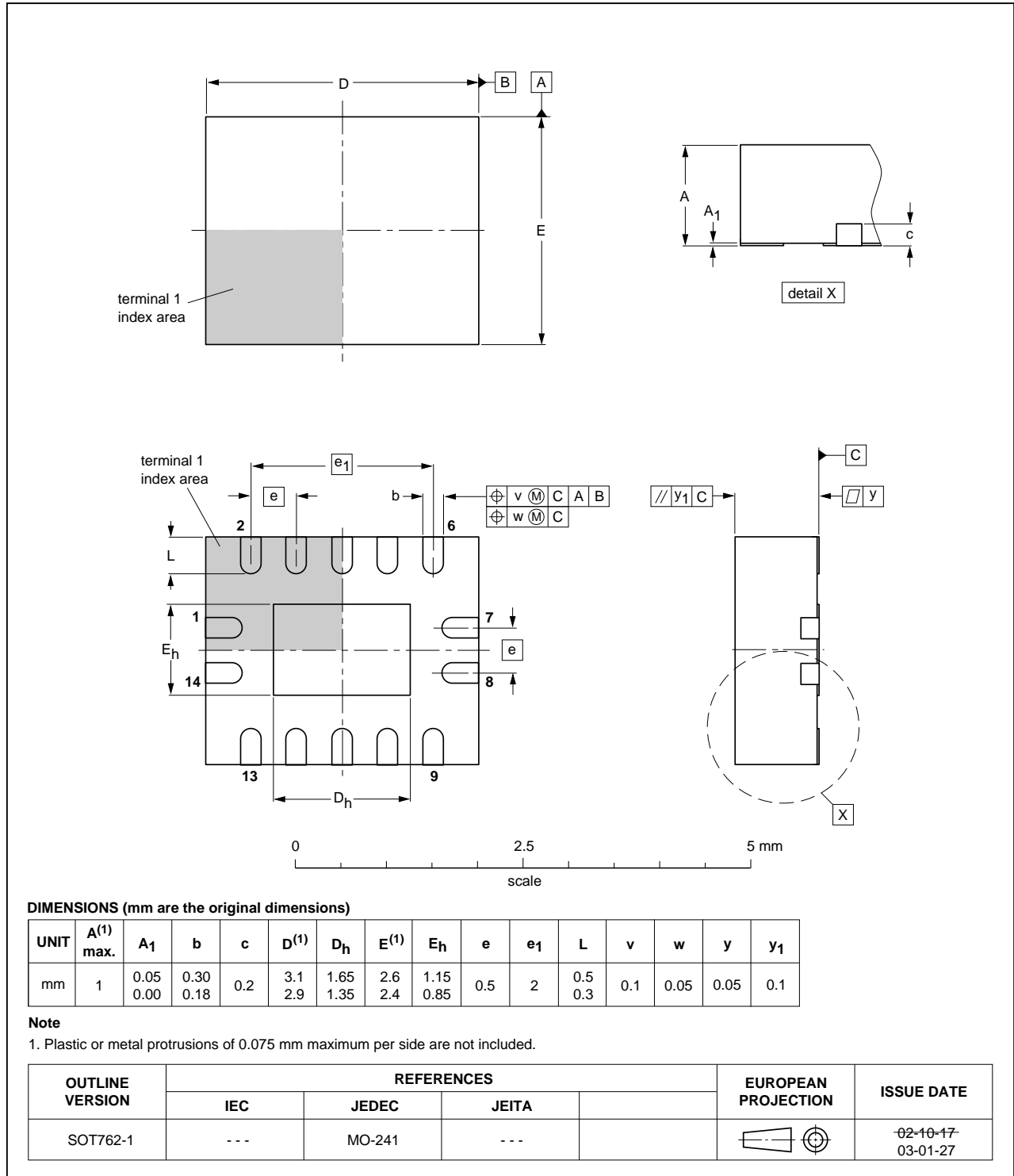

Fig 15. Package outline SOT762-1 (DHVQFN14)

16. Abbreviations

Table 11. Abbreviations

Acronym	Description
CMOS	Complementary Metal Oxide Semiconductor
DUT	Device Under Test
ESD	ElectroStatic Discharge
HBM	Human Body Model
MIL	Military
MM	Machine Model
TTL	Transistor-Transistor Logic

17. Revision history

Table 12. Revision history

Document ID	Release date	Data sheet status	Change notice	Supersedes
74LV132_Q100 v.1	20131111	Product data sheet	-	-

18. Legal information

18.1 Data sheet status

Document status ^{[1][2]}	Product status ^[3]	Definition
Objective [short] data sheet	Development	This document contains data from the objective specification for product development.
Preliminary [short] data sheet	Qualification	This document contains data from the preliminary specification.
Product [short] data sheet	Production	This document contains the product specification.

[1] Please consult the most recently issued document before initiating or completing a design.

[2] The term 'short data sheet' is explained in section "Definitions".

[3] The product status of device(s) described in this document may have changed since this document was published and may differ in case of multiple devices. The latest product status information is available on the Internet at URL <http://www.nexperia.com>.

18.2 Definitions

Draft — The document is a draft version only. The content is still under internal review and subject to formal approval, which may result in modifications or additions. Nexperia does not give any representations or warranties as to the accuracy or completeness of information included herein and shall have no liability for the consequences of use of such information.

Short data sheet — A short data sheet is an extract from a full data sheet with the same product type number(s) and title. A short data sheet is intended for quick reference only and should not be relied upon to contain detailed and full information. For detailed and full information see the relevant full data sheet, which is available on request via the local Nexperia sales office. In case of any inconsistency or conflict with the short data sheet, the full data sheet shall prevail.

Product specification — The information and data provided in a Product data sheet shall define the specification of the product as agreed between Nexperia and its customer, unless Nexperia and customer have explicitly agreed otherwise in writing. In no event however, shall an agreement be valid in which the Nexperia product is deemed to offer functions and qualities beyond those described in the Product data sheet.

18.3 Disclaimers

Limited warranty and liability — Information in this document is believed to be accurate and reliable. However, Nexperia does not give any representations or warranties, expressed or implied, as to the accuracy or completeness of such information and shall have no liability for the consequences of use of such information. Nexperia takes no responsibility for the content in this document if provided by an information source outside of Nexperia.

In no event shall Nexperia be liable for any indirect, incidental, punitive, special or consequential damages (including - without limitation - lost profits, lost savings, business interruption, costs related to the removal or replacement of any products or rework charges) whether or not such damages are based on tort (including negligence), warranty, breach of contract or any other legal theory.

Notwithstanding any damages that customer might incur for any reason whatsoever, Nexperia's aggregate and cumulative liability towards customer for the products described herein shall be limited in accordance with the *Terms and conditions of commercial sale* of Nexperia.

Right to make changes — Nexperia reserves the right to make changes to information published in this document, including without limitation specifications and product descriptions, at any time and without notice. This document supersedes and replaces all information supplied prior to the publication hereof.

Suitability for use in automotive applications — This Nexperia product has been qualified for use in automotive applications. Unless otherwise agreed in writing, the product is not designed, authorized or warranted to be suitable for use in life support, life-critical or safety-critical systems or equipment, nor in applications where failure or malfunction of a Nexperia product can reasonably be expected to result in personal injury, death or severe property or environmental damage. Nexperia and its suppliers accept no liability for inclusion and/or use of Nexperia products in such equipment or applications and therefore such inclusion and/or use is at the customer's own risk.

Applications — Applications that are described herein for any of these products are for illustrative purposes only. Nexperia makes no representation or warranty that such applications will be suitable for the specified use without further testing or modification.

Customers are responsible for the design and operation of their applications and products using Nexperia products, and Nexperia accepts no liability for any assistance with applications or customer product design. It is customer's sole responsibility to determine whether the Nexperia product is suitable and fit for the customer's applications and products planned, as well as for the planned application and use of customer's third party customer(s). Customers should provide appropriate design and operating safeguards to minimize the risks associated with their applications and products.

Nexperia does not accept any liability related to any default, damage, costs or problem which is based on any weakness or default in the customer's applications or products, or the application or use by customer's third party customer(s). Customer is responsible for doing all necessary testing for the customer's applications and products using Nexperia products in order to avoid a default of the applications and the products or of the application or use by customer's third party customer(s). Nexperia does not accept any liability in this respect.

Limiting values — Stress above one or more limiting values (as defined in the Absolute Maximum Ratings System of IEC 60134) will cause permanent damage to the device. Limiting values are stress ratings only and (proper) operation of the device at these or any other conditions above those given in the Recommended operating conditions section (if present) or the Characteristics sections of this document is not warranted. Constant or repeated exposure to limiting values will permanently and irreversibly affect the quality and reliability of the device.

Terms and conditions of commercial sale — Nexperia products are sold subject to the general terms and conditions of commercial sale, as published at <http://www.nexperia.com/profile/terms>, unless otherwise agreed in a valid written individual agreement. In case an individual agreement is concluded only the terms and conditions of the respective agreement shall apply. Nexperia hereby expressly objects to applying the customer's general terms and conditions with regard to the purchase of Nexperia products by customer.

No offer to sell or license — Nothing in this document may be interpreted or construed as an offer to sell products that is open for acceptance or the grant, conveyance or implication of any license under any copyrights, patents or other industrial or intellectual property rights.

Export control — This document as well as the item(s) described herein may be subject to export control regulations. Export might require a prior authorization from competent authorities.

Translations — A non-English (translated) version of a document is for reference only. The English version shall prevail in case of any discrepancy between the translated and English versions.

18.4 Trademarks

Notice: All referenced brands, product names, service names and trademarks are the property of their respective owners.

19. Contact information

For more information, please visit: <http://www.nexperia.com>

For sales office addresses, please send an email to: salesaddresses@nexperia.com

20. Contents

1	General description	1
2	Features and benefits	1
3	Applications	1
4	Ordering information	2
5	Functional diagram	2
6	Pinning information	3
6.1	Pinning	3
6.2	Pin description	3
7	Functional description	4
8	Limiting values	4
9	Recommended operating conditions	5
10	Static characteristics	5
11	Dynamic characteristics	6
12	Waveforms	6
13	Transfer characteristics	7
14	Waveforms transfer characteristics	8
15	Package outline	10
16	Abbreviations	13
17	Revision history	13
18	Legal information	14
18.1	Data sheet status	14
18.2	Definitions	14
18.3	Disclaimers	14
18.4	Trademarks	15
19	Contact information	15
20	Contents	16

Mouser Electronics

Authorized Distributor

Click to View Pricing, Inventory, Delivery & Lifecycle Information:

[Nexperia:](#)

[74LV132D-Q100J](#) [74LV132PW-Q100J](#) [74LV132BQ-Q100X](#)