

40 mm sq. type

Model no.	Surface treatment	Mass (g)
109-059	Nickel-chrome plating (silver)	7
109-059H	Cation electropainting (black)	

Inlet side, Outlet side

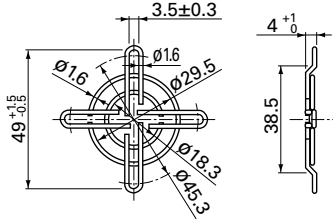

Mounting example

Axial fan

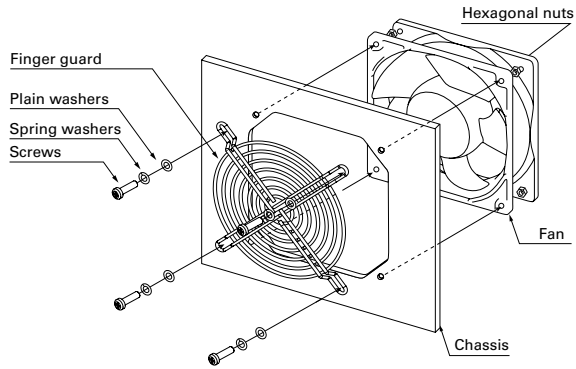

Mouser Electronics

Authorized Distributor

Click to View Pricing, Inventory, Delivery & Lifecycle Information:

[Sanyo Denki:](#)

[109-059](#) [109-059H](#)