

General Specifications

Electrical Capacity (Resistive Load)

Power Level (code W):	3A @ 125V AC
Logic Level (code G):	0.4VA maximum @ 28V AC/DC maximum (Applicable Range 0.1mA ~ 0.1A @ 20mV ~ 28V)
Logic/Power Level (code A):	Combines W & G ratings Note: See Supplement section to find explanation of operating range.

Other Ratings

Contact Resistance:	20 milliohms maximum for silver; 30 milliohms maximum for gold
Insulation Resistance:	1,000 megohms minimum @ 500V DC
Dielectric Strength:	1,000V AC minimum between contacts for 1 minute minimum; 1,500V AC minimum between contacts & case for 1 minute minimum
Mechanical Life:	200,000 operations minimum
Electrical Life:	25,000 operations minimum for silver; 100,000 operations minimum for gold
Nominal Operating Force:	Single pole 2.45N; double pole 3.92N
Travel:	Pretravel .024" (0.6mm); Overtravel .016" (0.4mm); Total Travel .039" (1.0mm)

Materials & Finishes

Plunger:	Brass with nickel plating
Bushing:	Brass with nickel plating
Mounting & Body Frames:	Stainless steel
Support Bracket:	Brass with tin plating
Case:	Polybutylene terephthalate (PBT) (UL94V-0)
Base:	Diallyl phthalate resin
Movable Contactor:	Phosphor bronze with silver or gold plating
Movable Contacts:	Silver alloy (code W); copper with gold plating (code G)
Stationary Contacts:	Silver with silver plating (code W); copper or brass with gold plating (code G)
Terminals:	Copper with silver plating; copper or brass with gold plating

Environmental Data

Operating Temp Range:	-30°C through +85°C (-22°F through +185°F)
Humidity:	90 ~ 95% humidity for 100 hours @ 40°C (104°F)
Vibration:	10 ~ 55Hz with peak-to-peak amplitude of 1.5mm traversing the frequency range & returning in 1 minute; 3 right angled directions for 2 hours
Shock:	50G (490m/s ²) acceleration (tested in 6 right angled directions, with 5 shocks in each direction)

Installation

Mounting Torque:	1.5Nm (13 lb•in) for double nut; 0.7Nm (6 lb•in) for single nut
Cap Installation Force:	80N (18 lbf) maximum downward force on actuator

Processing

Soldering:	Wave Soldering Recommended: See Profile B in Supplement section. Manual Soldering: See Profile B in Supplement section.
Cleaning:	These devices are not process sealed. Hand clean locally using alcohol based solution.

Standards & Certifications

Flammability Standards:	UL94V-0 Case
UL :	File No. E44145 - Recognized only when ordered with marking on switch. Add "/U" or "/CUL" before dash in part number to order UL recognized switch. All single & double pole models recognized at 3A @ 125V AC or 0.4VA max. @ 28V AC/DC max.
CSA:	File No. 023535_0_000 - Certified only when ordered with marking on switch. Add "/C" before dash in part number to order CSA certified switch. Single pole & double pole models certified at 3A @ 125V AC or 0.4VA max. @ 28V AC/DC max.

Distinctive Characteristics

Short stroke and light touch.

Antijamming design protects contacts from damage due to excessive downward force on the actuator.

High torque bushing construction prevents rotation or separation from frame during installation.

Stainless steel frame resists corrosion.

Longer center solder lug terminal simplifies wiring and soldering.

Patented silver contacts of specially composed alloy for hardness.

Epoxy sealed terminals prevent entry of solder flux and other contaminants.

Snap-acting mechanism gives smooth actuation and audible feedback.

Prominent external insulating barriers increase insulation resistance and dielectric strength.

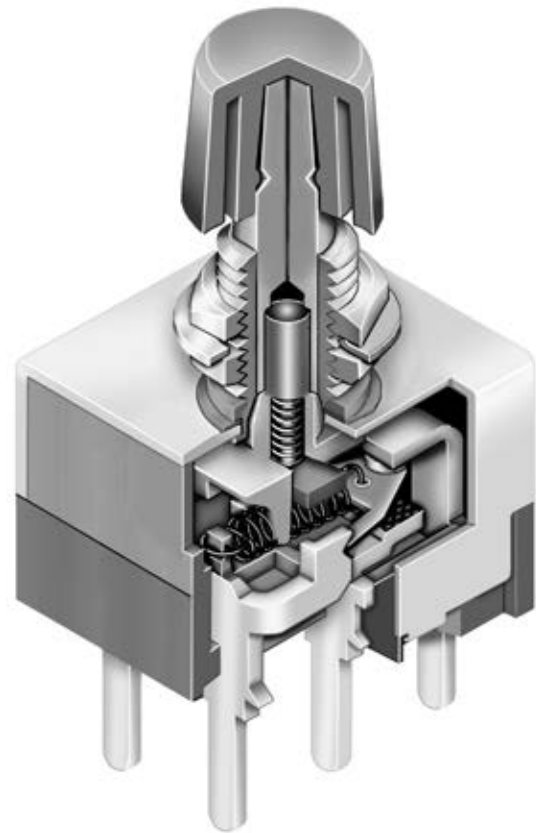

Actual Size

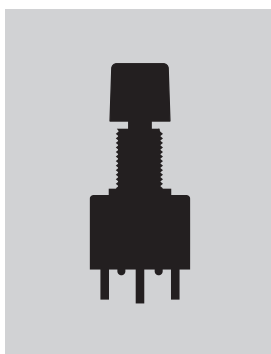

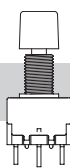
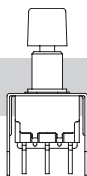
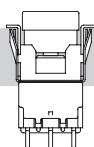
	Bushing Mount	Page C118
	Bracket PC Mount	Page C121
	Snap-in Mount	Page C124

- Toggle
- Rockers
- Pushbuttons**
- Illuminated PB
- Programmable
- Keylocks
- Rotaries
- Slides
- Tactiles
- Tilt
- Touch
- Indicators
- Accessories
- Supplement

TYPICAL SWITCH ORDERING EXAMPLE

MB25

11

S4

W

01

B

C

Poles & Circuits

11	SPDT	ON	(ON)
21	DPDT	ON	(ON)
() = Momentary			

Contact Materials & Ratings

W	Silver Rated 3A @ 125V AC
G	Gold Rated 0.4VA max @ 28V AC/DC max

Caps

B	.315" (8.0mm) Diameter
C	.394" (10.0mm) Diameter

Bushing

S4	.315" (8.0mm) Threaded with Keyway
-----------	---------------------------------------

Terminals

01	Solder Lug
03	.250" (6.35mm) Straight PC

Cap Colors

A	Black
B	White
C	Red
E	Yellow
F	Green
G	Blue

IMPORTANT:



Switches are supplied without UL, cULus & CSA marking unless specified.
UL, cULus & CSA recognized only when ordered with marking on the switch.
 Specific models, ratings, & ordering instructions are noted on the General Specifications page.



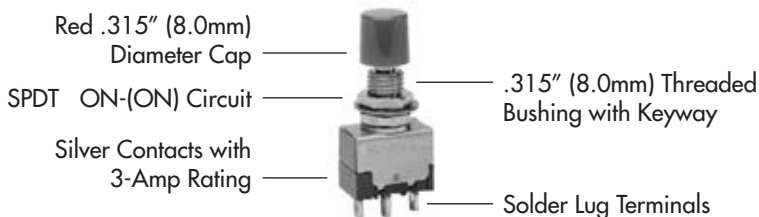

DESCRIPTION FOR TYPICAL ORDERING EXAMPLE

MB2511S4W01-BC



Toggles
 Rockers
 Pushbuttons
 Illuminated PB
 Programmable
 Keylocks
 Rotaries
 Slides
 Tactiles
 Tilt
 Touch
 Indicators
 Accessories
 Supplement

POLES & CIRCUITS

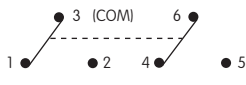
Pole	Model	Plunger Position () = Momentary		Connected Terminals		Throw & Switch Schematics
		Normal  Keyway	Down 	Normal  Keyway	Down 	
SP	MB2511	ON	(ON)	3-1	3-2	SPDT 
DP	MB2521	ON	(ON)	3-1 6-4	3-2 6-5	DPDT 

Note: Terminal numbers are not actually on the switch.

BUSHING

S4 .315" (8.0mm)
Threaded with Keyway

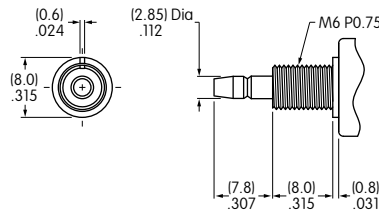

Panel Cutouts

Without Keyway

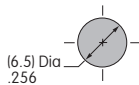

With Keyway

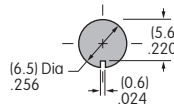

With Optional Locking Ring

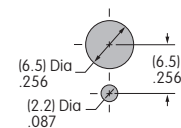

Maximum Panel Thickness with Standard Hardware: .134" (3.4mm)

Standard Hardware

AT513M Threaded
Hex Nut

2 included
with each switch

Brass with
nickel plating

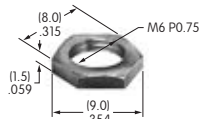

AT509
Lockwasher

1 included
with each switch

Steel with
zinc/chromate

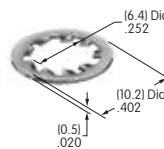

Optional Hardware

AT507M
Locking Ring

Steel with
zinc/chromate

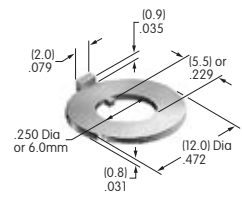

CONTACT MATERIALS & RATINGS

W Silver over Silver

Power Level

3A @ 125V AC

G Gold over Brass or Copper

Logic Level

0.4VA maximum @ 28V AC/DC maximum

Note: Complete explanation of operating range in Supplement section.

Toggles
Rockers
Pushbuttons
Illuminated PB
Programmable
Keylocks
Rotaries
Slides
Tactiles
Tilt
Touch
Indicators
Accessories
Supplement

Toggle

Rockers

Pushbuttons

Programmable Illuminated PB

Keylocks

Rotaries

Slides

Tactiles

Tilt

Touch

Indicators

Accessories

Supplement

TERMINALS

01 Solder Lug

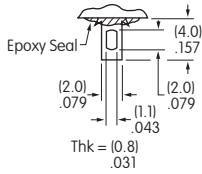

03 .250" (6.35mm) Straight PC

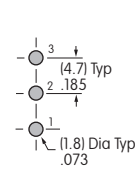
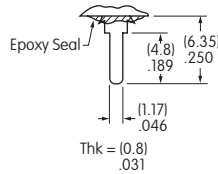

Single Pole

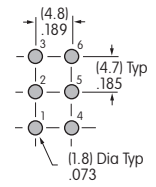

Double Pole

CAPS & CAP COLORS

B AT443
.315" (8.0mm) Diameter Cap

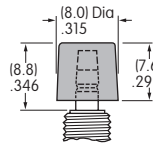

Material: Polycarbonate

Finish: Glossy

C AT442
.394" (10.0mm) Diameter Cap

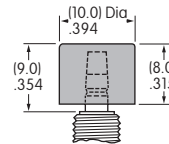

Material: Polycarbonate

Finish: Glossy

Cap Colors Available:

- A** Black
- B** White
- C** Red
- E** Yellow
- F** Green
- G** Blue

TYPICAL SWITCH DIMENSIONS

Solder Lug

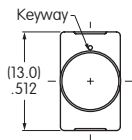

Single Pole

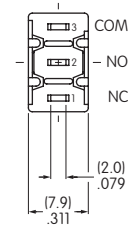
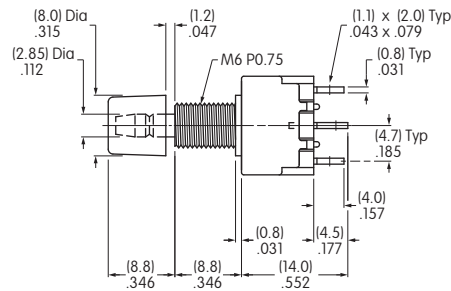

MB2511S4W01-BC

Solder Lug

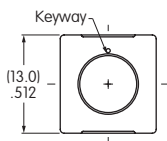

Double Pole

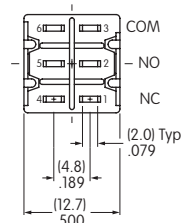
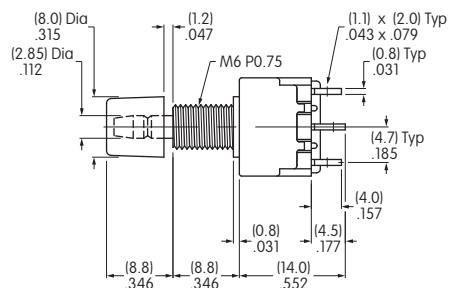

MB2521S4W01-BC

TYPICAL SWITCH ORDERING EXAMPLE

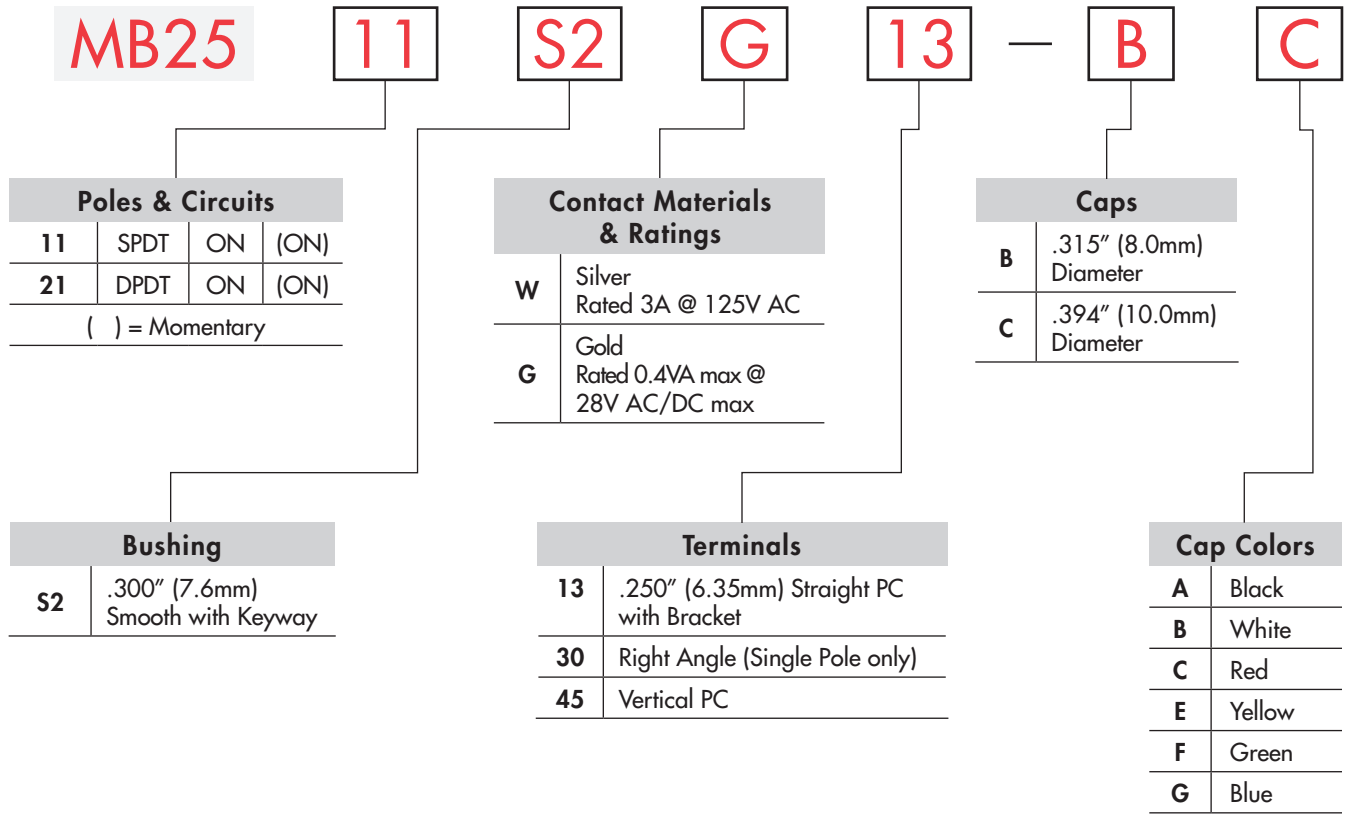

IMPORTANT:



Switches are supplied without UL, cULus & CSA marking unless specified. **UL, cULus & CSA recognized only when ordered with marking on the switch.** Specific models, ratings, & ordering instructions are noted on the General Specifications page.

DESCRIPTION FOR TYPICAL ORDERING EXAMPLE

MB2511S2G13-BC

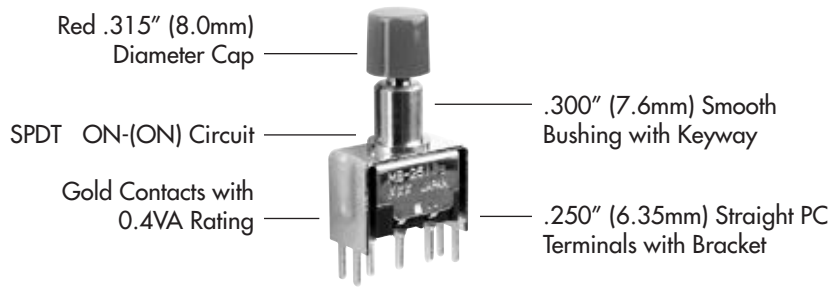

- Toggle
- Rockers
- Pushbuttons**
- Illuminated PB
- Programmable
- Keylocks
- Rotaries
- Slides
- Tactiles
- Tilt
- Touch
- Indicators
- Accessories
- Supplement

Toggles

Rockers

Pushbuttons

Illuminated PB

Programmable

Keylocks

Rotaries

Slides

Tactiles

Tilt

Touch

Indicators

Accessories

Supplement

POLES & CIRCUITS

Pole	Model	Plunger Position () = Momentary		Connected Terminals		Throw & Switch Schematics
		Normal	Down	Normal	Down	
						Note: Terminal numbers are not actually on the switch.
SP	MB2511	ON	(ON)	3-1	3-2	SPDT
DP	MB2521	ON	(ON)	3-1 6-4	3-2 6-5	DPDT

BUSHING

S2 .300" (7.6mm)
Smooth with Keyway

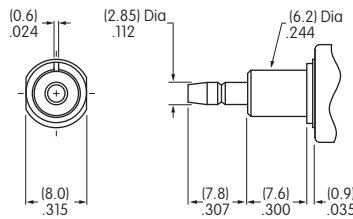

Panel Cutout

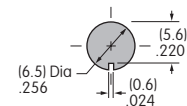

CONTACT MATERIALS & RATINGS

W Silver over Silver

Power Level

3A @ 125V AC

G Gold over Brass or Copper

Logic Level

0.4VA maximum @ 28V AC/DC maximum

Note: Complete explanation of operating range in Supplement section.

TERMINALS

13 .250" (6.35mm) Terminal
with .465" (11.8mm) Bracket

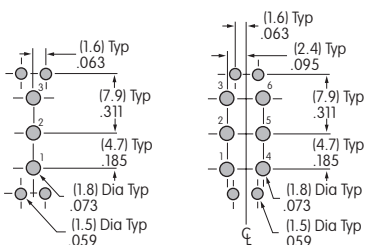
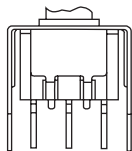

30 Right Angle PC
Single Pole only

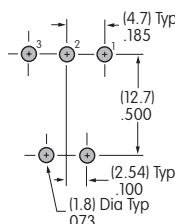
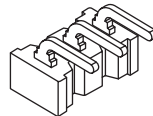

45 Vertical PC

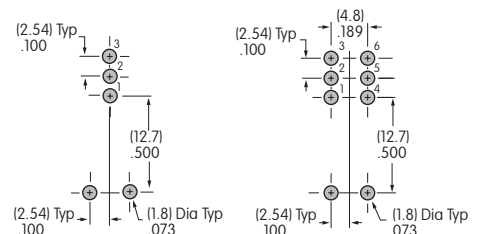
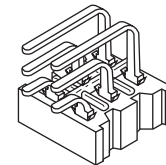

CAPS & CAP COLORS

B AT443
.315" (8.0mm) Diameter Cap



Material: Polycarbonate

Finish: Glossy

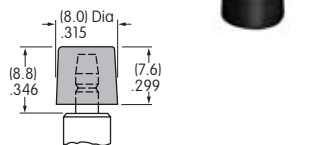

C AT442
.394" (10.0mm) Diameter Cap



Material: Polycarbonate

Finish: Glossy

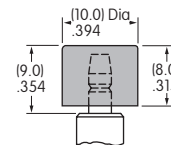

Cap Colors Available:



Black



White



Red



Yellow



Green



Blue

TYPICAL SWITCH DIMENSIONS

Single Pole

Double Pole

Straight PC • Bracket

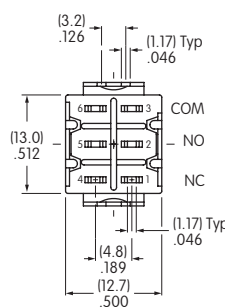
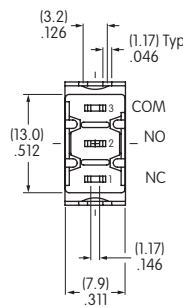
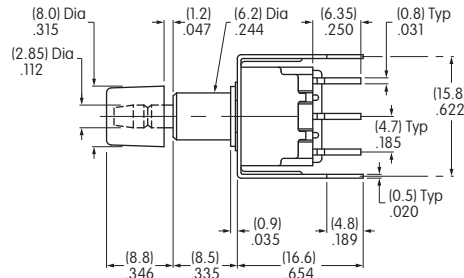
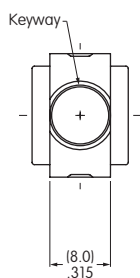

MB2511S2G13-BC

Single Pole

Right Angle PC

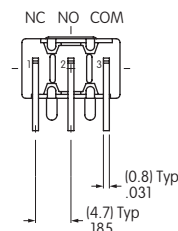
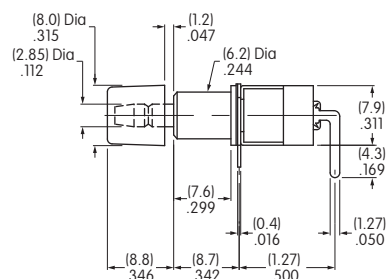
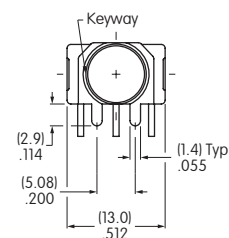

MB2511S2G30-BC

Single Pole

Double Pole

Vertical PC

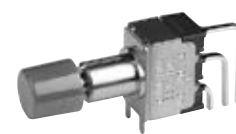
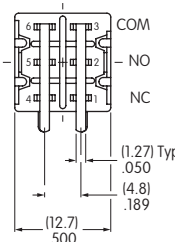
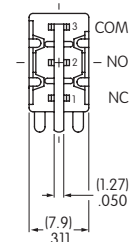
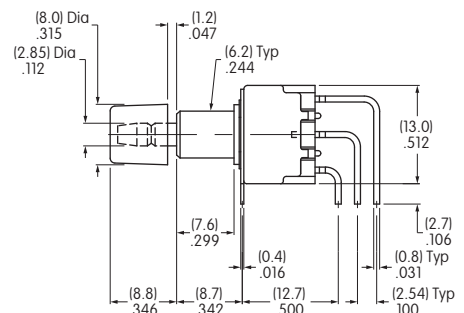
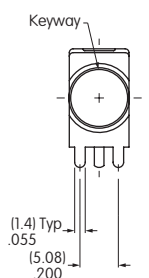

MB2511S2G45-BC

Toggles
Rockers
Pushbuttons
Illuminated PB
Programmable
Keylocks
Rotaries
Slides
Tactiles
Tilt
Touch
Indicators
Accessories
Supplement

TYPICAL SWITCH ORDERING EXAMPLE

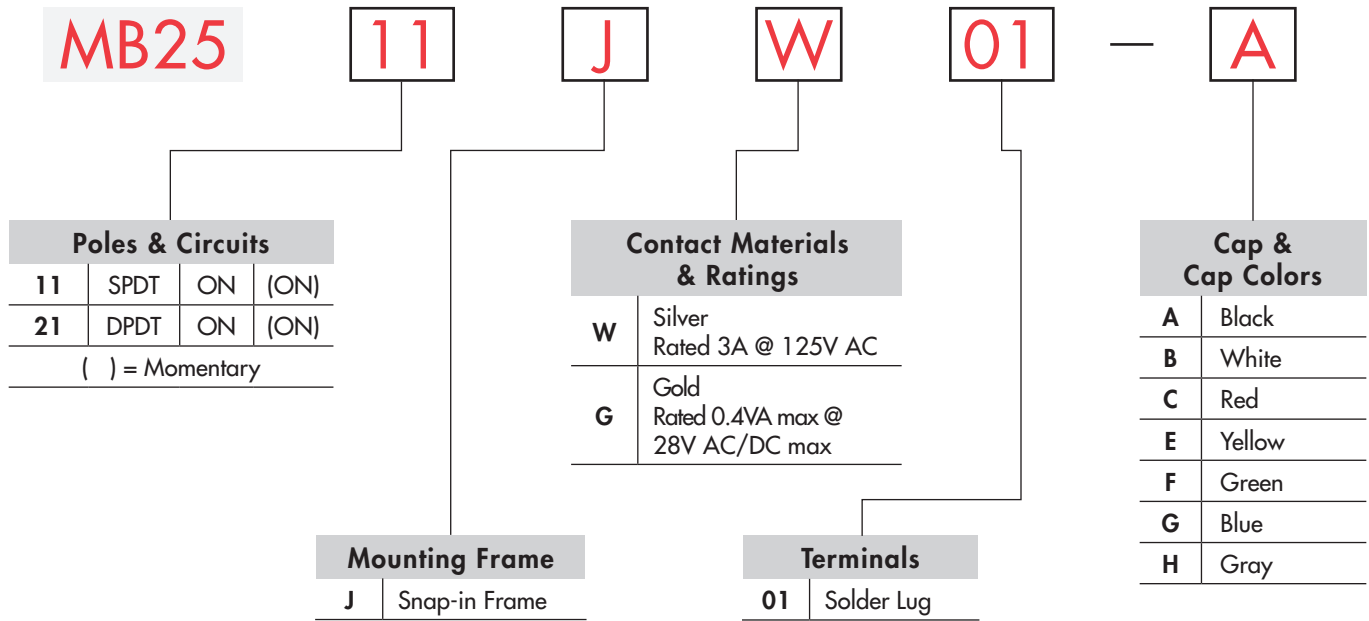

IMPORTANT:









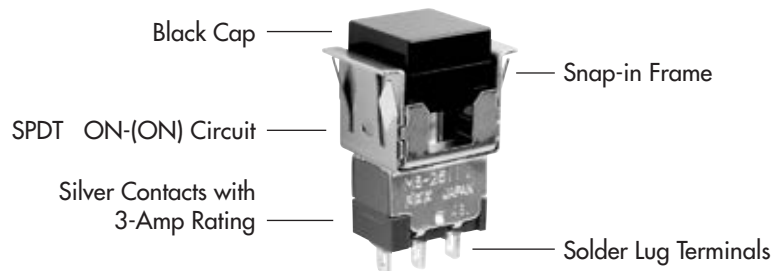

Switches are supplied without UL, cULus & CSA marking unless specified. **UL, cULus & CSA recognized only when ordered with marking on the switch.** Specific models, ratings, & ordering instructions are noted on the General Specifications page.

DESCRIPTION FOR TYPICAL ORDERING EXAMPLE

MB2511JW01-A

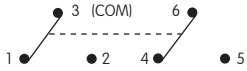

POLES & CIRCUITS

Pole	Model	Plunger Position () = Momentary		Connected Terminals		Throw & Switch Schematics
		Normal	Down	Normal	Down	
SP	MB2511	ON 	(ON) 	3-1 	3-2 	Note: Terminal numbers are not actually on the switch. SPDT 
DP	MB2521	ON 	(ON) 	3-1 6-4 	3-2 6-5 	DPDT 

MOUNTING FRAME

J

Snap-in Frame

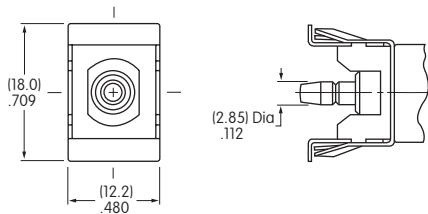

Panel Cutout for Single Pole without Bezel

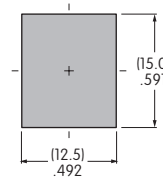

Panel Cutout for Double Pole without Bezel

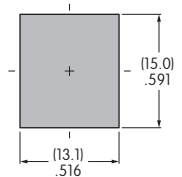

Panel Thickness without Bezel: .039" ~ .157" (1.0mm ~ 4.0mm)
Panel Thickness with Bezel: .039" ~ .126" (1.0mm ~ 3.2mm)

CONTACT MATERIALS & RATINGS

W

Silver over Silver

Power Level

3A @ 125V AC

G

Gold over Brass or Copper

Logic Level

0.4VA maximum @ 28V AC/DC maximum

Note: Complete explanation of operating range in Supplement section.

TERMINALS

01

Solder Lug

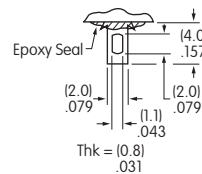

CAP & CAP COLORS

AT465

.453" (11.5mm) Square Cap

Material: Polycarbonate
Finish: Glossy

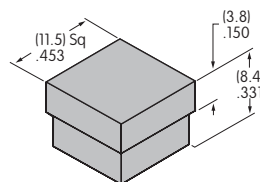

Contact factory for matte finish.

Cap Colors Available:

A

Black

B

White

C

Red

E

Yellow

F

Green

G

Blue

H

Gray

TYPICAL SWITCH DIMENSIONS

Solder Lug



MB2511JW01-A

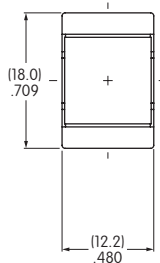

Single Pole

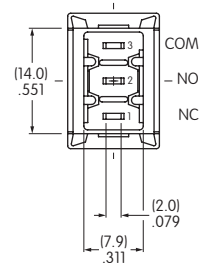
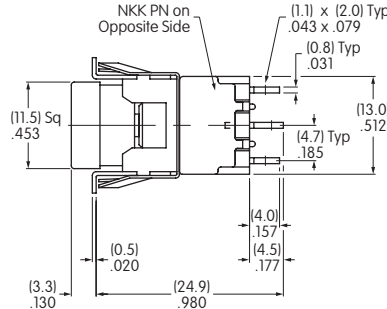

Solder Lug



MB2521JW01-C

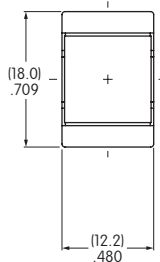

Double Pole

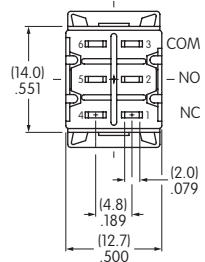
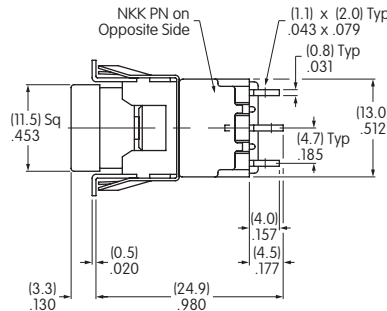

OPTIONAL SNAP-IN BEZELS & BEZEL COLORS

AT207 Bezel

Material: Polycarbonate
Finish: Glossy

Colors:
Black, White, Red, Yellow,
Green, Blue, Gray

Contact factory for matte finish.

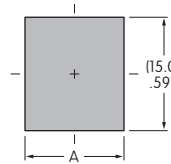
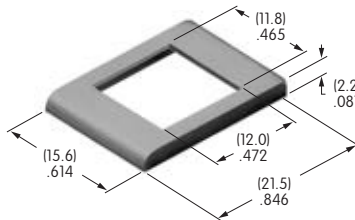

	Single Pole	Double Pole
A	(12.5mm) .492"	(13.1mm) .516"

AT208 Bezel for AT070 LED

Material: Polycarbonate
Finish: Glossy

Color: Black

Contact factory for matte finish.

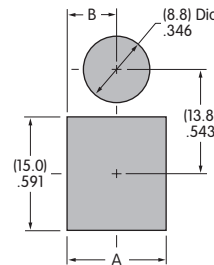
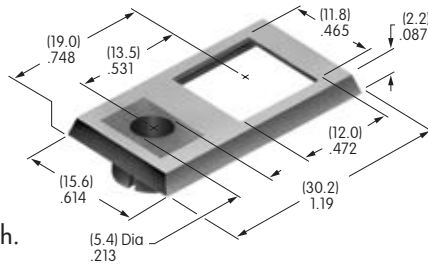

	Single Pole	Double Pole
A	(12.5mm) .492"	(13.1mm) .516"
B	(6.25mm) .246"	(6.55mm) .258"

AT212 Bezel for AT617 LED

Material: Polycarbonate
Finish: Semi-glossy

Color: Black

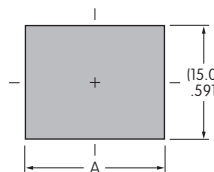
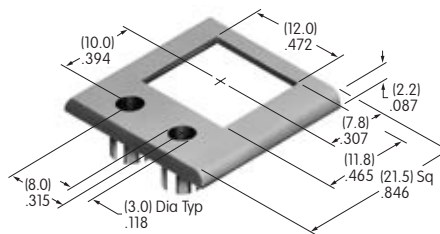

	Single Pole	Double Pole
A	(18.4mm) .724"	(18.7mm) .736"

OPTIONAL SNAP-IN BEZELS & BEZEL COLORS

AT213 Bezel for AT618 LED

Material:
Polycarbonate
Finish:
Semi-glossy

Color:
Black

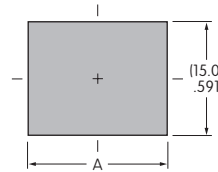
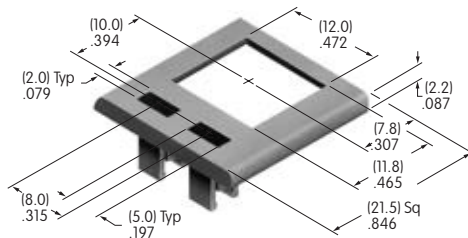

	Single Pole	Double Pole
A	(18.4mm) .724"	(18.7mm) .736"

Bezel Assembly

1. Pry out tab on bezel to a 45° angle.

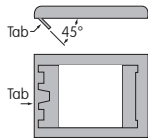

2. Insert switch frame under tab and snap on the bezel.

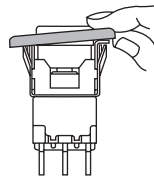

3. Push tab back into place.

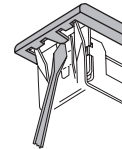

4. Snap assembled bezel and switch into panel.

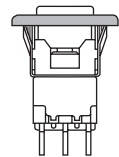

LED COLORS & SPECIFICATIONS

Bezel Orientation on Switch

AT070 LED For Bezel AT208 with 1 LED

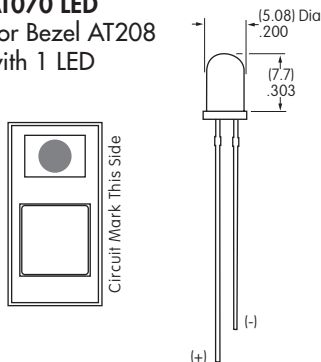

AT617 LED For Bezel AT212 with 2 Round LEDs

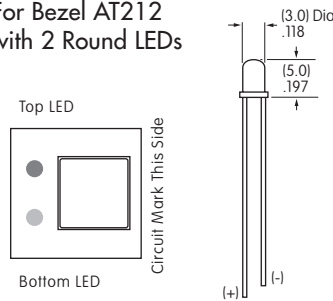

AT618 LED For Bezel AT213 with 2 Rectangular LEDs

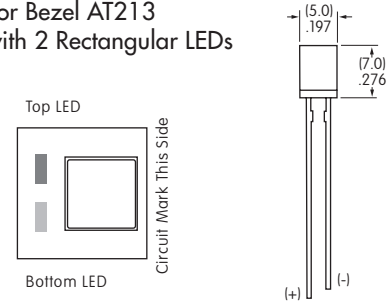

Note: Lead lengths may differ from manufacturing lot to lot. The longer lead is the anode (+).

		AT070		AT617			AT618		
		C	F	C	E	F	C	E	F
Color		Red	Green	Red	Yellow	Green	Red	Yellow	Green
Maximum Forward Current	I_{FM}	25mA	50mA	30mA	30mA	25mA	25mA	30mA	25mA
Typical Forward Current	I_F	20mA	30mA	20mA	20mA	20mA	20mA	20mA	20mA
Forward Voltage	V_F	2.8V	2.1V	2.0V	2.1V	2.25V	2.25V	2.1V	2.2V
Maximum Reverse Voltage	V_{RM}	4V	5V	5V	5V	5V	5V	5V	5V
Current Reduction Rate Above 25°C	ΔI_F	0.33 mA/°C	0.40 mA/°C	0.40 mA/°C	0.40 mA/°C	0.33 mA/°C	0.33 mA/°C	0.40 mA/°C	0.33 mA/°C
Ambient Temperature Range (when used with a bezel)		-10° ~ +70°C		-15° ~ +70°C			-25° ~ +70°C		

The electrical specifications shown are determined at a basic temperature of 25°C.
LED circuit is independent of switch operation. LED is colored in OFF state.

If the source voltage is greater than the rated voltage of the LED, a ballast resistor must be connected in series with the LED.
The ballast resistor calculation and more lamp detail are shown in the Supplement section.

Mouser Electronics

Authorized Distributor

Click to View Pricing, Inventory, Delivery & Lifecycle Information:

NKK Switches:

[MB2511S4W01](#) [MB2511S4G01](#) [MB2511S4G01-BC](#) [MB2511S4G01-BA](#) [MB2511S4W01-CC](#) [MB2511S4G03](#)
[MB2511S4W03](#) [MB2521S4G01](#) [MB2521S4G03](#) [MB2521S4W01](#) [MB2521S4W03](#) [MB2511S4W01-BA](#)
[MB2521S4W01-CA](#) [MB2521S4W01-CE](#) [MB2521S4W01-CF](#) [MB2521S4W01-CB](#) [MB2521S4W01-CG](#)
[MB2511S4G03-BA](#) [MB2511S4W01-BC](#) [MB2511S4W01-CE](#) [MB2511S4W01-CB](#) [MB2511S4W01-CG](#)
[MB2521S4W01/U](#)